



MOEX Spectra Terminal

User guide

version 6.5

Copyright © 2020 Moscow exchange

Annotation

This user guide covers processes of using the terminal application for trading securities and derivatives.

The document contains information about the trader workstation, its trading possibilities, conditions of use, processes, work processes and rules.

Table of Contents

Introduction	9
1. General information	10
1.1. Purpose of the application	10
1.2. Derivatives market	10
1.2.1. Trading participants	10
1.2.2. Instruments	11
1.2.3. Trading operations	11
1.3. Function diagram of the trading terminal	12
2. Application management	13
2.1. System requirements and used software	13
2.2. Trading terminal application setup	13
2.3. Application version update for Windows	13
2.4. Application automatic update	16
2.5. User roles	19
3. Quick start	20
4. How to start and how to finish working with trading terminal	22
4.1. Application start and user sign in	22
4.2. Change password	22
4.3. Transport connect	23
4.3.1. Testing network connections	24
4.4. Transport disconnect	24
4.5. Transport reconnect using another profile	25
4.6. Exit the application	25
4.7. Transport status	26
4.8. Disconnect	26
4.9. Abnormal application termination	27
5. User interface	29
5.1. Main window	29
5.2. Main menu	30
5.3. Instrument panel	37
5.4. Side panel	38
5.5. Status line	40
5.6. Main functional windows	41
5.7. Workspace configuration	41
5.7.1. New workspace configuration	42
5.7.2. Saving configurations	43
5.7.3. Restoring configuration	43
5.7.4. Restore default settings	43
5.8. Basic configuration	43
5.9. Windows management	44
5.9.1. Tabs in the workspace	44
5.9.1.1. Actions with tabs	44
5.9.1.2. Window tab	45
5.9.1.3. Panel tabs	46
5.9.2. Unpinned window	47
5.9.3. Arranging windows	48
5.9.4. Managing active window	49
5.9.4.1. Minimize window	50
5.9.4.2. Maximize window	51
5.9.4.3. Move window	51
5.9.4.4. Change window size	51
5.9.4.5. How to force window to stay on top	51
5.9.4.6. Opening new windows as tabs	52
5.9.4.7. Close window	52
5.9.4.8. Save and restore window configuration	52

5.9.5. Switch between functional windows	52
5.10. General work practices	52
5.10.1. Editing fields	53
5.10.2. Sorting data	53
5.10.3. Contextual search in tables	53
5.10.4. Filtering	54
5.10.4.1. Filtering settings via the window settings menu item	55
5.10.5. Context menu. General algorithm.	55
5.11. Auxiliary dialog boxes	56
5.11.1. Select instrument window	56
5.11.2. Favorite instruments	57
5.11.2.1. Favorite instruments window	58
5.12. Data export	60
5.12.1. Interactive data export	60
5.12.2. Dynamical data export	61
5.12.2.1. Cancelling dynamical export	63
6. Using the application functions	64
6.1. Viewing information	64
6.1.1. Information – parameters of the current record	64
6.1.2. Financial instruments	67
6.1.2.1. Filters in the Financial instruments window	70
6.1.2.2. Filter for instruments in the Financial instruments window	72
6.1.2.3. Sorting in the Financial instruments window	74
6.1.2.4. Contextual menu in the Financial instruments window	75
6.1.3. Sessions window	76
6.1.4. News window	77
6.1.4.1. Sound settings on adding a new string in the table	78
6.1.5. Money	79
6.1.6. Positions	79
6.1.6.1. Toolbar of the Positions/ requests window	82
6.1.6.2. Transfer position from one BF position to another (within the same CF).	82
6.1.6.3. Filtering in the Positions/ requests window	83
6.1.7. Positions by settlement accounts	85
6.1.7.1. Filtering in the 'Positions by settlement accounts' window	86
6.2. Orders	88
6.2.1. Your orders/ requests window	88
6.2.1.1. Filters in the Your orders/ requests window	91
6.2.1.2. Context menu in the Your orders/ requests window	94
6.2.1.3. Sound settings on adding a new string in the table	95
6.2.1.4. Change order	96
6.2.2. Order-book	97
6.2.2.1. Toolbar of the Order-book window	98
6.2.2.2. Setting the Order-book window appearance	98
6.2.2.2.1. Standard mode	99
6.2.2.2.2. Narrow mode	100
6.2.2.2.3. Wide mode	101
6.2.2.2.4. Rarefied mode	102
6.2.2.2.5. Order-book window with fixed centre	102
6.2.2.3. Highlight volume	103
6.2.2.4. Sorting strings in the Order-book window	104
6.2.2.5. One-click trading setting	104
6.2.2.6. One-click trading, key combinations settings	106
6.2.2.7. Orders panel	109
6.2.2.7.1. Position indicator	110
6.2.2.7.2. Setting the opening position	111
6.2.2.7.3. Setting the opening price	111
6.2.2.8. Setting sound notification	111
6.2.2.9. Context menu in the Order-book window	112

6.2.3. Adding orders into the trading system	113
6.2.3.1. Adding order window	113
6.2.4. Iceberg orders	117
6.2.5. Request to NCC	118
6.2.6. Indicative quotes	119
6.2.7. Synthetic orders. Synthetic matching	120
6.2.8. Postponed orders (batch entry)	122
6.2.8.1. Toolbar of the Postponed orders window	123
6.2.8.2. Adding orders into the list and editing them	124
6.2.8.3. Removing postponed orders	125
6.2.8.4. Sending postponed orders into the Trading system	125
6.2.8.5. Import	125
6.2.9. Dynamical order adding	127
6.2.10. Unprocessed orders	131
6.2.11. Order cancellation	132
6.2.12. Checking price for limits and multiplicity	133
6.2.13. Messages window	133
6.2.14. Risk balancing	134
6.3. Trades	134
6.3.1. All trades/ requests window	135
6.3.1.1. Filtering in the All trades/ requests window	136
6.3.1.2. Context menu in the All trades/ requests window	138
6.3.2. Your trades/ requests window	139
6.3.2.1. Filtering in the Your trades/ requests window	142
6.3.2.2. Context menu in the Your trades/ requests window	142
6.4. Negotiated operations	142
6.4.1. Negotiated orders	143
6.4.1.1. Adding negotiated orders	143
6.4.2. Negotiated trades	144
6.5. Multi-leg instruments operations	144
6.5.1. Multi-leg instruments orders	144
6.5.1.1. Adding orders for anonymous multi-leg instruments	145
6.5.1.2. Negotiated multi-leg instruments orders	145
6.5.2. Multi-leg instruments trades	146
6.6. RFS (active streams)	147
6.6.1. Toolbar in the 'RFS (active streams)' window	149
6.6.2. Filters in 'RFS (active streams)' window	150
6.6.3. Creating liquidity stream	152
6.6.4. Adding quotes to the liquidity stream by the provider (LP)	154
6.6.4.1. Cancellation of provider quotes	156
6.6.5. Make a trade	157
6.6.6. Liquidity stream closing	158
6.7. Administrator and Trading System's messages	159
6.7.1. Administrator's messages	159
6.7.2. Errors and notifications	160
6.7.3. Transaction error messages	161
7. Options	162
7.1. Options board	162
7.1.1. Filters in the Options board window	165
7.1.2. Filtering by instruments in the Options board window	167
7.1.3. Sorting in the Options board window	168
7.1.4. Context menu in the Options board window	169
7.2. Options exercising	170
7.2.1. Options exercise orders	170
7.2.2. Options exercising rules	171
7.2.2.1. Automatic order generation algorithm	171
7.2.2.2. Option exercise orders removing algorithm	172
7.3. Volatility curve	172

7.4. Options calculator	173
7.4.1. Toolbar of Option calculator	174
7.4.2. Real portfolio	175
7.4.2.1. Generating real portfolio data based on virtual portfolio data	177
7.4.3. Virtual portfolio	177
7.4.3.1. Import data into virtual portfolio	180
7.4.3.2. Add position into virtual portfolio	182
7.4.3.3. Add strategy into virtual portfolio	183
7.4.3.4. Remove position from virtual portfolio	185
7.4.3.5. Virtual portfolio data export	185
7.4.3.6. Recalculate collateral	185
7.4.3.7. Greeks calculation formulas	186
7.4.3.7.1. Black-Scholes model	186
7.4.3.7.2. Bachelier model	187
7.4.4. Charts	188
7.4.4.1. Modeling values for charts	190
7.4.4.2. Charts export to text file format	191
7.4.4.3. Charts export to image file format	191
8. Management	192
8.1. Market maker obligations for options	192
8.1.1. Filters in the Market maker obligations for options window	195
8.2. Market maker obligations for futures	196
8.2.1. Filters in the Market maker obligations for futures window	199
8.2.2. Setting sound notification at non-fulfillment of obligations	201
8.2.3. Setting visual warning for default of market maker obligations	202
8.3. Limitation window	202
8.3.1. Toolbar of the Limitation window	206
8.3.2. Setting the client limits	207
8.3.3. Setting BF limits	208
8.3.4. Changing client limits	208
8.3.5. Lock mode	209
8.3.6. Funds transfer between BFs	210
8.3.7. Request to NCC for collateral verification of Brokerage Firm	211
8.4. Settlement account assets	211
8.5. Manage BF parameters	213
8.5.1. Setting BF's parameters	214
8.5.2. Setting shared parameters for BF's clients	215
8.6. Manage client parameters	216
8.6.1. Toolbar of the Manage client parameters window	218
8.6.2. Setting client parameters used in evening clearing	218
8.6.3. Setting client parameters used immediately	219
8.6.4. Setting the expiration risks parameters	220
8.6.5. Setting the brokerage fee	221
8.7. Prohibitions on operations for clients	222
8.7.1. Toolbar of the Prohibitions window	224
8.7.2. Setting prohibitions for operations	224
8.7.3. Setting group of prohibitions	226
8.7.4. Change prohibition	229
8.7.5. Prohibitions on adding option exercising orders	229
8.7.6. Prohibitions for RFS	229
8.8. Option exercise rules	230
8.8.1. Toolbar in the Option exercise rules window	231
8.8.2. Setting a new options exercise rule	231
8.9. Removing limits, prohibitions and rules	232
8.10. Users	232
8.11. SMA-user order verification	233
8.11.1. Add SMA-user pre-trade verification	234
8.12. Settlement account assets (clearing)	236

8.13. Client assets (clearing)	237
8.14. Collateral breakdown	238
8.15. Withdrawal funds from the trading system	238
8.15.1. Sending a new withdrawal request	240
8.15.2. Recalling withdrawal request	241
8.16. Position profiles transfer requests	242
8.16.1. Toolbar of the Position profiles transfer requests window	243
8.16.2. Position profiles transfer by asset	243
8.16.3. Position profile transfer request information	245
8.17. Collateral transfer requests	246
8.17.1. Toolbar of the Collateral transfer requests window	248
8.17.2. Collateral transfer	248
8.17.3. Collateral profile transfer requests information	251
9. Technical analysis. Charts.	253
9.1. Chart types	253
9.2. Tech. analysis window	255
9.2.1. Toolbar in the Tech. analysis window	256
9.2.2. Context menu in the Tech. analysis window	260
9.3. Charts of series	261
9.3.1. Creating a chart	261
9.3.2. Charts properties	263
9.4. Indicators	264
9.4.1. Creating indicator charts	266
9.4.2. Indicator selecting window	267
9.4.3. Indicator chart properties	267
9.5. Actions with charts	269
9.5.1. How to change a chart instrument	269
9.5.2. How to add more than one chart into the same window area	269
9.5.3. How to move chart into a new area of the current window	270
9.5.4. How to pin several charts to the same vertical axis	270
9.5.5. Moving charts between areas of the current window	271
9.5.6. How to find a 'lost' chart	271
9.5.7. How to hide a chart	271
9.5.8. How to change a chart name	272
9.5.9. How to remove a chart	272
9.5.10. How to change scale of a chart	273
9.5.11. How to move a chart along the time axis	273
9.6. Additional elements - graphical objects	273
9.6.1. Trend line	274
9.6.2. Resistance and support levels	275
9.6.3. Fibonacci lines	275
9.6.4. Fibonacci arcs	276
9.6.5. Fibonacci fan	277
9.6.6. Trend line properties	278
9.6.7. Moving trend lines	279
9.6.8. Moving charts including its trend lines	279
9.6.9. Removing graphical objects	279
9.6.10. Graphical objects visibility	279
9.7. Object manager	280
9.7.1. The Series tab	281
9.7.2. Indicators tab	281
9.7.3. Drawings tab	282
9.8. Indicator editor	283
9.8.1. Indicator code editor	283
9.8.2. Functions editor	286
9.8.3. QScript language extension	287
9.9. Chart settings	290
9.9.1. Confirmation settings for charts	290

9.9.2. Loading data from ISS. Setting bar location	292
9.9.3. Session schedule	294
9.9.4. Series charts settings	295
9.9.5. Indicators settings	297
9.9.6. Chart colour settings	298
9.9.7. Offset settings	299
9.10. Managing Technical analysis data	299
9.10.1. TA data import	299
9.10.2. TA data export	302
9.10.3. Editing TA data	304
10. Main settings	306
10.1. Notification settings	306
10.2. Setting the terminal appearance	308
10.3. Confirmations settings	310
10.4. News sources settings	314
10.5. Colour settings	315
10.6. Database settings	318
10.7. Management confirmations settings	320
10.8. Hot keys settings	320
10.9. Network settings	323
10.10. Confirmations settings in the option calculator	324
10.11. Plugins settings	325
10.12. Sounds settings	326
10.13. TA archival data	327
10.14. Information window settings	328
10.15. Graphical charts settings	329
10.16. Average position price settings	329
10.17. Transport settings	330
10.17.1. Connection profiles	333
10.17.2. Loading data from ISS	333
10.18. Saving settings	334
10.19. Writing log-files	335
11. Using context menus for windows configuration setting	336
11.1. Main group window settings	337
11.2. Highlight settings	337
11.3. Columns settings	339
Index	340

Introduction

The Trading Terminal has the following key features and benefits:

- Modularity and expandability. Due to the modular architecture of the application, it is easy to expand its scope of the application in order to meet the current demands.
- High performance. The terminal application is able to accumulate and store a significant amount of market data during the trading session period, and also load some data from previous sessions.
- The 'all-in-one' feature. The trading terminal provides access to all markets of the stock exchange.
- Multilingual capability. Both Russian and English language versions are available since the very first build version.
- Ease of learning and use. The user interface of the application is simple but logically consistent, providing all possibilities for fine settings according to needs of every user. By default, the terminal application parameters are set to be the most convenient for the beginner traders.
- Security. The terminal provides authentication and authorisation procedures in accordance with the Plaza2 security standards.
- Multiplatform application. The terminal can be installed and used with several operating systems: Windows, MacOS (not supported since version 6.2) and Linux.

This user guide is targeted to users (traders) who are familiar with the selected Operational System.

You can find some 'how-to' information as brief separate chapters named **Procedure**.

The sequence of the menu items is given as a line containing the whole menu items hierarchy starting from the very top level. The menu items are separated by slash, for example: the **File/ Connections/Transport status** main menu item.

Tab. 1. List of abbreviations

Abbreviation	Full name
TS	Trading System
CC	Clearing Center
CF	Clearing Firm
BF	Brokerage Firm
UA	Underlying Asset
CH	Clearing House
CT	Chief Trader
TA	Technical Analysis

Chapter 1. General information

This chapter contains information about the application and the basic terms of the derivatives market.

1.1. Purpose of the application

The trading terminal is a software application which provides the current market information to users and allows users to manage their own resources.

The application is used for trading exchange instruments in real-time mode.

The application allows users to trade on the SPECTRA trading floor, on different trading boards. The following operations are provided:

- futures and options trading;
- multi-leg instruments trading;
- negotiated trading.

1.2. Derivatives market

The general information about **SPECTRA** derivatives market, (i. e. administrative persons, the main regulators, the market missions, durations of trading sessions, derivatives market instruments and participants, etc.) can be found at site [<http://moex.com/ru/derivatives/>].

The main terms and rules of futures and options trading can be found at <http://fs.moex.com/files/4989>.

Some other documents, such as **Contracts specifications**, **Clearing rules**, etc. can be also found on the **MOEX** website.

Clients can add their orders into the trading system using the trading terminals software application or via the **P2Gate** software system.

1.2.1. Trading participants

Trading participants can be subdivided into the following three groups:

- clearing firms (CF);
- brokerage firms (BF);
- CF and BF clients.

Clearing firms are the firms which incur liabilities for risks and cover risks of their clients and sub-brokers.

Clearing firms are authorized to:

- perform trades on behalf of themselves and by their own accounts or by their clients' accounts;
- perform settlements on complete trades directly with the Exchange;
- service their clients, including brokers;
- exercise control over their clients and brokers during trading sessions.

Unlike clearing firms, **Brokerage firms** do not settle up with exchange directly; instead, they use their clearing firms. Also, brokerage firms are not obliged to obtain licences and pay fees to the Insurance fund.

Brokerage firms are authorized to:

- perform trades on behalf of themselves and their clients;
- exercise control over their clients during trading sessions.

Clients – any physical or corporate person can participate in the derivatives market as a client on the authority of trading service agreement signed with a brokerage firm or with clearing firm directly. VAT identification number and passport number are required, in accordance with Russian Federation legislation, as a measure to prevent cross trades (trades where the same person represents both seller and buyer).

1.2.2. Instruments

On the derivatives market, instruments are structured hierarchically.

Underlying asset is an entity related to a certain contract. Therefore, it can be a stock in a stock exchange, a lot of commodity in a commodities exchange or an index/exchange rate/indicator for settling futures. All instrument of a certain underlying asset have the same attributes. Underlying asset is not a trading instrument.

Futures contracts are the main trading instruments in the FORTS system. Each futures contract is linked to a certain underlying asset and has its own unique characteristics of the maturity (the date of delivery), lot characteristics, minimum price step and cost of the price step value.

The date of delivery is specified with 3-months interval for every future contract, i.e. mid-March, mid-June, mid-September and mid-December. There can be more than one futures contract for each underlying asset.

Options - is a derived instrument from futures. There are two types of options: the futures-style options and the equity-style options.

Once an option is exercised, its position turns into a futures position which the option was initially linked to.

There are various exercise dates for various options. Unlike futures, there may exist 'short' option positions, aimed to be exercised in the middle of the next month. Once the option is exercised, its position turns into a 3-months futures position.

At opening, an amount of strike price values is specified for each option. These strike price values are dispersed near the price value of the futures contract, which the option was initially linked to.

Indexes - are a compound marker of price change for a particular series of securities. As a rule, the absolute values of indexes are not important. The more important thing is how the indexes change with time as it indicates the general market trend. According to values, an index may indicate trends either for a series of securities or for the whole market. Often, indexes are used as underlying assets for financial instruments with the same name.

Multi-leg instruments - the instruments consisting of more than one components. This allows to use a trading strategy, when a client gets additional positions on two or more instruments when trade is complete.

1.2.3. Trading operations

Order — a command, which is sent into the trading system by a trading participant, aimed to perform an action of buying or selling an instrument at specified price. There are two main types of orders available: negotiated and system.

System orders is the most common order type, which all clients can see and access. If there is a matching order in the trading system, the system order will match into a trade with the price of the matching order. The unmatched part of the order will remain in queue as another system order with a less amount of instruments.

There are three types of orders: *quotation order*, *matching order* and *Fill-or-Kill order*.

A **quotation order** remains in queue, no matter if it has been matched partially or was not matched at all.

A **matching order** is removed from the trading system if it has not been matched into any trade. If a matching order is matched partially, its unmatched part is also removed from the trading system.

A **Fill-or-Kill orders** must be either matched fully or removed from the trading system.

All orders are also subdivided into single-day orders and multi-day orders.

The **system orders** do not have any expiration date set. If unexercised, such orders remain in the trading system till the end of the current trading session.

Multi-day orders always have their date of expiration (1 day to 1 year). Unlike the system orders, multi-day orders are automatically relisted at the end of a trading session, with a new ID and a link to the very first order. When relisted, the order is verified for instrument availability, client availability and funds sufficiency. When expired, such orders are removed automatically at the end of the evening trading session (if there is any).

A **negotiated order** is addressed to a particular client (brokerage firm). Other clients cannot see and access these orders.

Negotiated orders cannot be matched partially.

Trades are performed for two orders if the orders prices match each other for the same instrument. The trade price is equal to the price of an order added first in the trading system.

There are two types of trades: system and negotiated. Trades are not removed from the trading system by user.

1.3. Function diagram of the trading terminal

Functionally, the application can be subdivided into three layers.

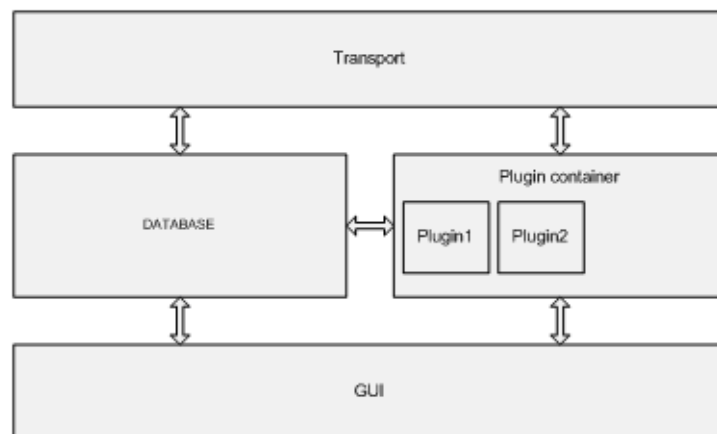

Fig. 1.1. Function diagram of the trading terminal

The **Transport** layer contains the exchange interaction subsystem which interact with the Plaza2 API, converts data from tables into the application native format and transmits messages into the MOEX trading system. Also, the **Transport** subsystem converts the MOEX data scheme into the one used within the terminal application.

The second layer contains the internal **Database** and the **Plugin** container subsystem, which manages the application extension modules aka plugins. The plugins defines the software application configuration and the application logic.

The third level contains the **GUI** — the application graphical user interface.

Chapter 2. Application management

This chapter describes the following topics:

- system requirements
- Installation package components and installation details,
- software version update details;
- user roles.

2.1. System requirements and used software

Tab. 2.1. PC configuration

	Minimum	Recommended
CPU	Intel 2.4 Ghz	Intel Core 2 Duo 2.8 GHz
Memory size	1 GB	8 GB
Hard drive	160 GB	160 GB

Program is based in part on the work of the Qwt project [<http://qwt.sf.net/>].

2.2. Trading terminal application setup

The application contains the executable file (*.exe), plugin modules, dynamic link libraries files (*.dll) and configuration files. While running, the application is able to create additional files such as data files, configuration profile files, protocol files, etc.

The application files can be found on the Moscow Exchange FTP-server.

The trading terminal is a cross-platform application, thus, it can be launched from several operating systems including:

- Windows;
- MacOS (not supported since version 6.2);
- Linux.

Each operating system requires its own installation package version.

The application documentation files in the PDF file format can be downloaded from the Moscow Exchange FTP-server. Also, the application contains the integrated context help system.

After installation complete, you can launch the application by clicking the shortcut on the desktop.

2.3. Application version update for Windows

1. Download the newest installation package version from the company's server. The installation package file name is **MOEXST-x86-N.NN.NNNN.msi**, where x86 or x64 - capacity of system (32 or 64), N.NN.NNNN - indicates a version number.
2. Backup the current application version files by copying them to another folder. It will help you to restore the application in case of any failure during installing of the newest version.
3. Launch **MOEXST-x86-N.NN.NNNN.msi**. The Setup Wizard dialog box will appear on the screen.

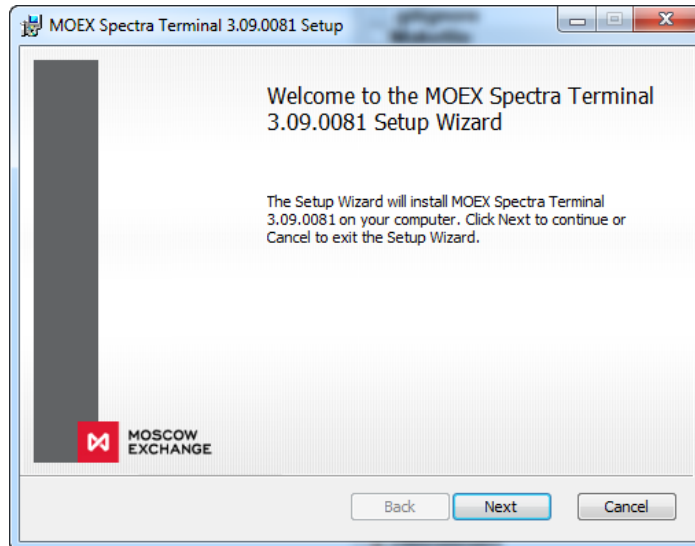

Fig. 2.1. Trading terminal Setup Wizard.

Click **Next** to continue setup.

4. Choosing Setup type.

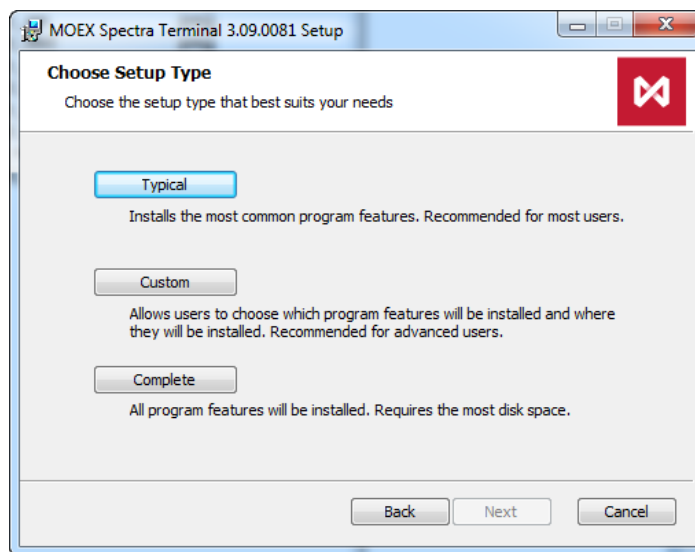

Fig. 2.2. Application Setup Wizard. Choosing Setup type.

Choose the Setup type. The recommended Setup type is **Typical**; in this case, the program shortcut will be automatically added on the desktop.

If you do not want to add the application shortcut on the desktop, you should select the **Custom** Setup type. In the dialog box, (fig. 2.3) open the **Desktop Shortcuts** list and select the **Entire feature will be unavailable** option.

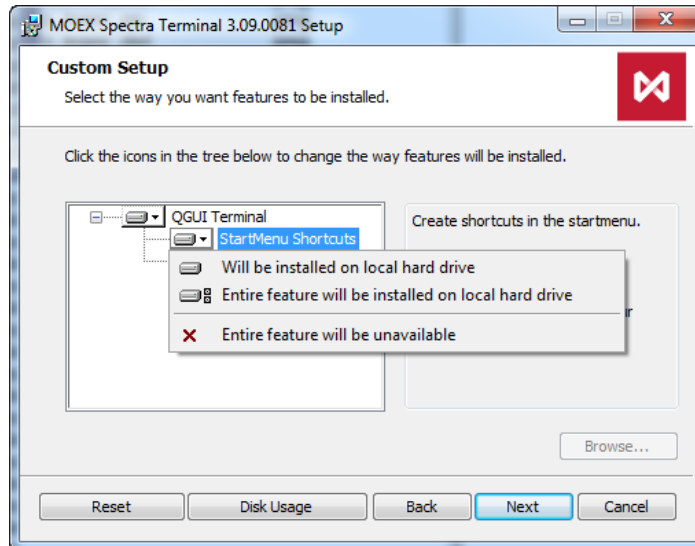

Fig. 2.3. Desktop shortcut settings.

Press **Next** to continue.

5. The next dialog box will invite you to install the application onto your hard drive.

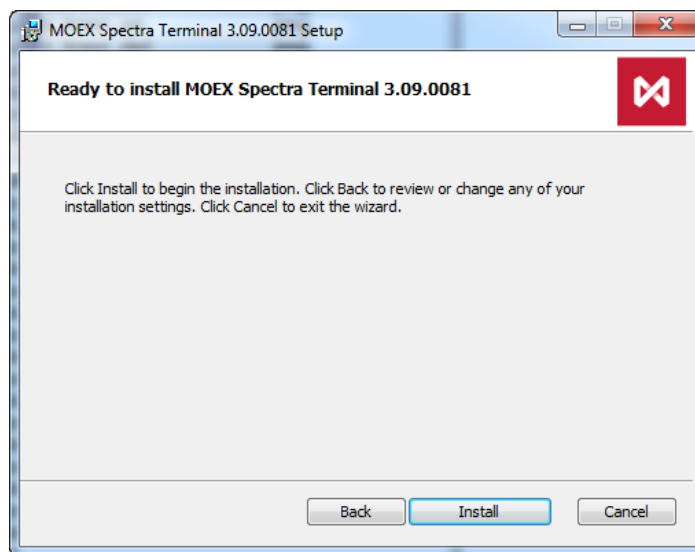

Fig. 2.4. Application Setup Wizard. Installation confirmation.

Press **Install** to continue.

6. The diagram in the next dialog box will show the installation progress:

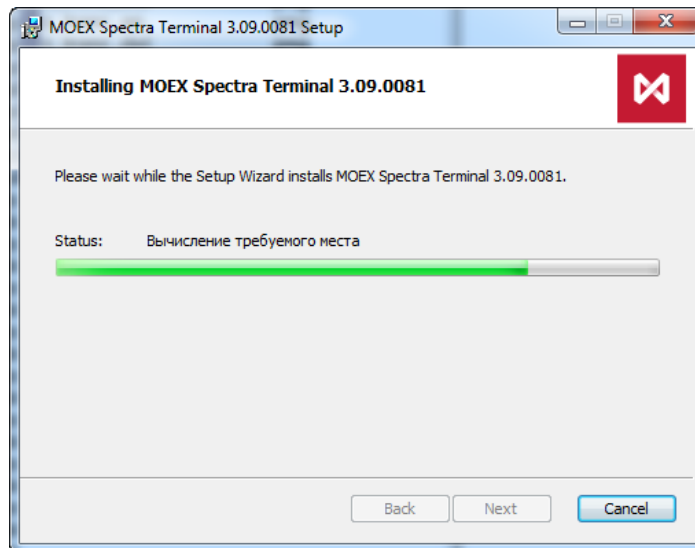

Fig. 2.5. Application Setup Wizard. Installation progress.

The default installation folder is *C:\Program Files\MOEX Spectra Terminal*.

7. After setup is complete, press **Finish** to exit the Setup Wizard. You can automatically launch the terminal after installation. To do this, set the option **Launch application when setup exit**.

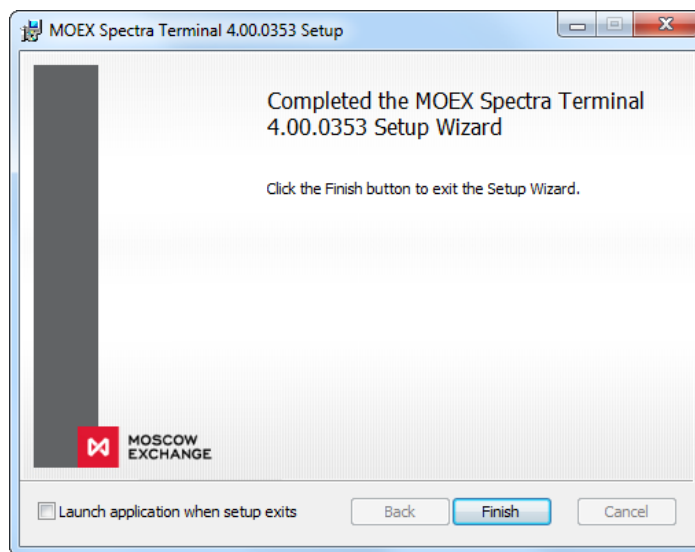

Fig. 2.6. Application Setup Wizard. Finishing setup.

If any time you need to get back, press the **Back** button in the bottom of the dialog boxes.

If you need to cancel the installation, press the **Cancel** button. Then you will be asked if you are sure to cancel the installation process or not. Press **Yes** to cancel the installation or press **No** to continue the installation.

If you cancel the installation, no changes will be made to the trading terminal files.

All the user settings made in the previous application version remain unchanged. The configuration files can be found at (c:\Users\UserName\AppData\Local\Moscow Exchange\QGUI\

2.4. Application automatic update

The application automatically detects if a new version is already available on server.

The application checks for a new version availability every midnight (according to the local system time), or, additionally, when the trading terminal application starts.

The new version availability check time cannot be changed by user.

If there is a newer version of installation file available, a notification will appear in the trading terminal application status bar:



Fig. 2.7. Automatic update. Notification on a new version.

To check the availability of a new version you should restart the application (or wait until midnight). If there is a newer version of installation file available on the FTP-server, a notification will appear in the trading terminal application status bar.

Also, a notification will appear in the notification bar above the trading terminal application icon (when running):

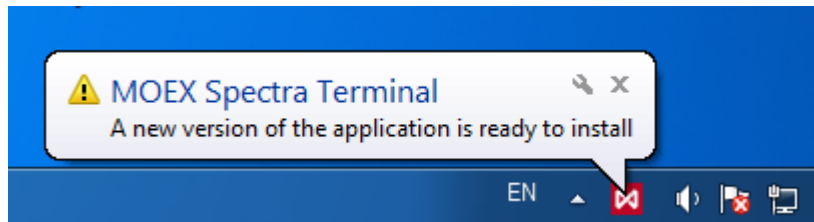

Fig. 2.8. Automatic update. Notification message in the notification bar.

To start downloading a new version, you should click the notification message with the left mouse button.

Before download starts, you should select a download folder:

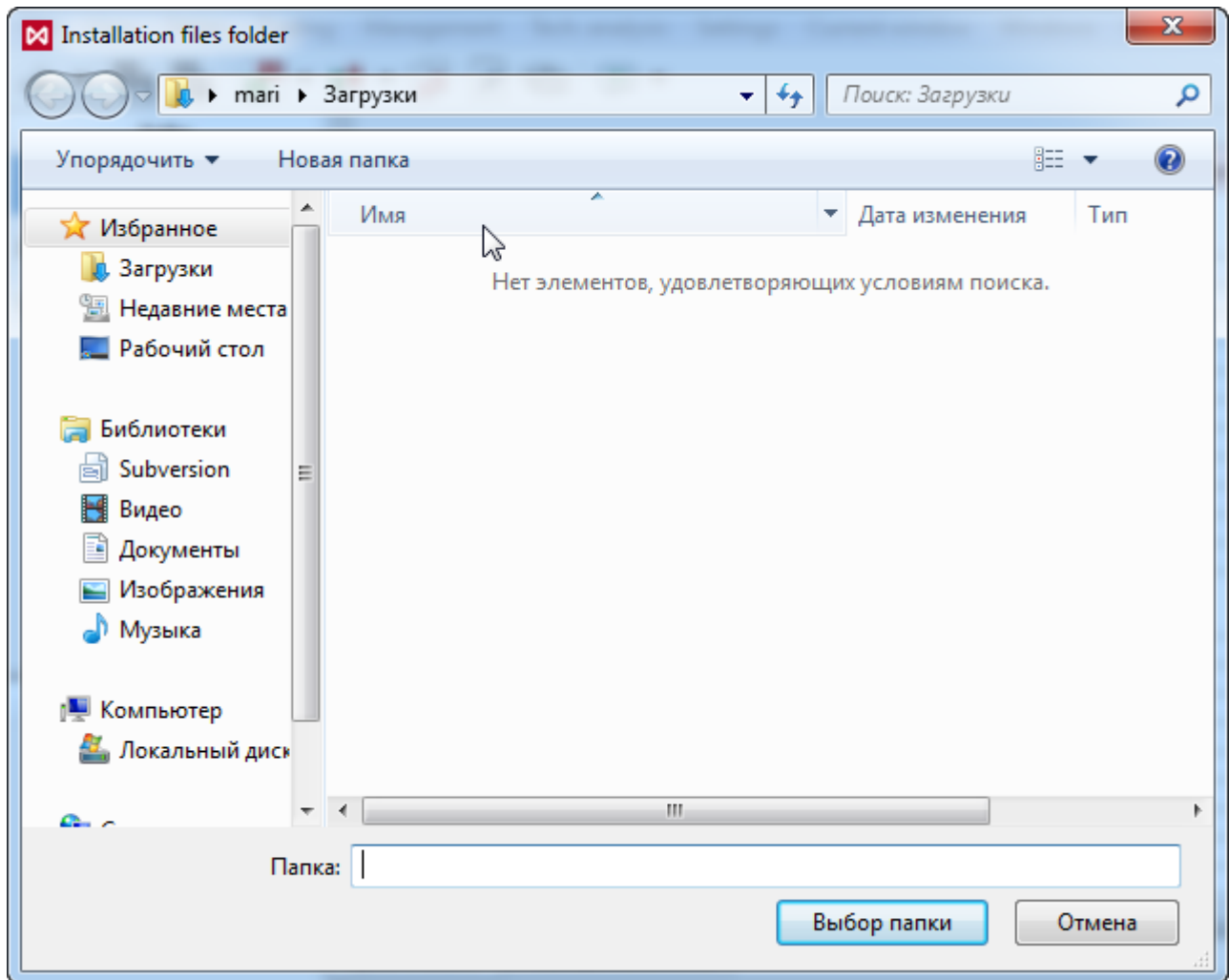

Fig. 2.9. Automatic update. Selecting download folder.

After download has started, the progress-bar will inform you about details of the download process.

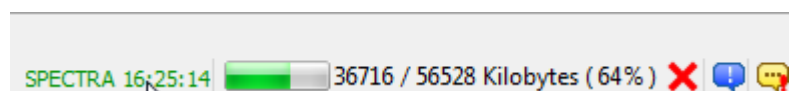

Fig. 2.10. Automatic update. Download process.

When the download complete, a notification will appear in the terminal application status bar:

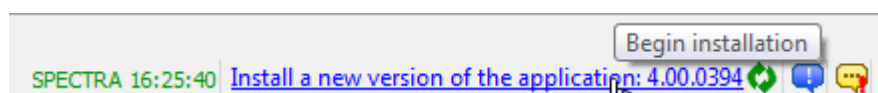

Fig. 2.11. Automatic update. Installing new version.

To start installation, click the notification with the left mouse button. To install the update, the application software requires restart, and the appropriate message will appear on the screen:

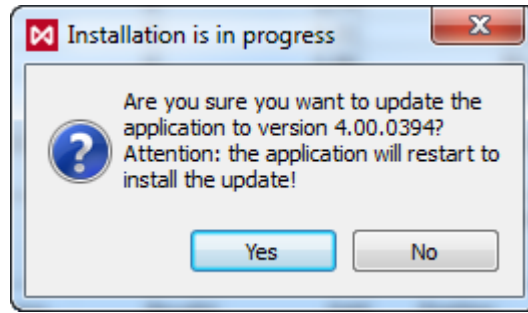

Fig. 2.12. Automatic update. Notification on restart.

If you select **Yes**, the terminal application will be stopped. After installation complete, the terminal application will restart automatically.

If you select **No**, the installation will be cancelled. The terminal application will continue running.

2.5. User roles

Users can be granted with different rights and permissions (roles or logins):

- The clearing firm login is able to view information and (if allowable) act on behalf of any broker or any client of the clearing firm. Also, it is able to set limits for its clients and sub-brokers. A Participant belonging to a Clearing Firm may, in general case, represent both Clearing Participant and Trading Participant, simultaneously. If the Participant acts solely as Clearing Participant, they are not allowed to perform trading operations.
- The brokerage firm login is able to view information and act on behalf of all clients of one or several brokerage firms within the same clearing firm. Also, it is able to set limits for these brokerage firms clients (only if the given Brokerage Firm is granted with right; this right can be obtained to both Clearing Participant and Trading Participant). A Brokerage Firm level participant can be either a Clearing Participant and a Trading participant represented by the same entity, or solely a Trading Participant.
- The client login is able to act on behalf of the particular client within the brokerage firm and view information concerning this client. A client level participant cannot be a Clearing Participant. Instead, a client level participant is always a Trading Participant.
- The 'view only' login is able to view trading activities of other trading participants. It is not allowed to act or interfere with trading sessions.

The user logins are set and managed by the system administrator. Therefore, the user role is specified at the application startup in accordance with the user login entered.

Chapter 3. Quick start

This chapter overviews the main steps to start working with the trading terminal.

For detailed information about the the components and operations please follow the hyper-links or look through the table of contents.

Application setup

First, you should install the application following all necessary steps.

Application start

The application can be launched by double clicking the application shortcut  located on the application folder (or on your desktop). Also, you can doubleclick the *Qgui.exe* file located in the application folder.

Connecting to trading floors

After launching the terminal, the **Connections** dialog box appears on the screen, where you should select a connection profile and enter your login and password obtained from the administrator.

If necessary, you can evoke the **Connections** dialog box later either from the **File/ Connections** menu or by clicking



button located on the toolbar. This dialog box is also used for disconnecting transports.

Workspace configuration

When you launch the application the first time, it the standard configuration is used, and all the main windows are situated on the same tab, and the side panel is activated.

The main application window, i.e. Financial instruments, Options board and Tech. analysis are displayed on the same window, divided by tabs.

The tabs shortcuts can be found on the side panel in the upper-left corner of the desktop. Please note that the workspace and windows configuration are changeable. Therefore, if you need to display all data of the current session, you should specify the filter settings for the main windows because some data may be screened by default.

For your convenience, you can create several workspaces and save each of them under its own unique name; in order to load a saved workspace, use **Settings/ Manage configurations**. By default, the changes you makes to desktop settings are automatically saved upon exiting the application and restored at application start – to enable this option, check the **Save the current desktop settings before exit** checkbox in the **Settings/Terminal settingsMOEX Spectra Terminal/Preferences** of the **Main/Common** section of the main menu. Also, you can save changes anytime using the **File/ Save configuration (Ctrl+S)** keys combination. If you need to undo the latest changes, it is possible to restore the default workspace via the **File/ Restore configuration** command of the main menu.

Tabs

Tabs are used for organizing windows. You can manage tabs in many ways: create new tabs, close them or change tabs configuration.

Windows

The main windows can be opened using the corresponding commands of the **Tables** menu. You can move windows within the tab or even move them to another tab. Each and every window can be opened in different tabs in one time.

You can find a brief description of the main windows at section 5.6.

Some basic operations with the current window are available via the **Current window** menu commands.

Every saved workspace can be specified as the default workspace. Therefore, every new window will be automatically created in accordance with the default window settings.

The window appearance and its main settings can be specified via **Window settings (Ctrl+E)**, which is available from either from the **Current window** menu or from context menu available in the window area.

Interface

You can execute the most of the terminal commands in several ways:

- using the application main menu;
- using instrument panels
- using context menus;
- using hotkeys.

Favorite instruments

You can organize some of your frequently used instruments into the **Favorite instruments** list. This group of instruments can be easily accessed from side panel, dropdown boxes for the main menu commands and instrument panel when adding orders or adding charts. The favorite list settings can be managed either by using **Settings/ Favorite instruments** or by drag-and-dropping instruments from the **Financial instruments** and **Options board** windows as well as from trade window and order windows.

Trading

All added orders are displayed in the Order-book window. Every Order-book contains orders for a particular instrument. You can open as many Order-book windows as you need. Also, you can turn on the One-Click trading mode - section 6.2.2.5, which allows to open the order adding dialog box just by clicking an order in the Order-Book.

There are several view modes available for the Order-Book: standard, narrow, wide and rarefied. Also, you can fixate the Order-Book centre by checking the appropriate checkbox.

The orders panel within the Order-Book window displays your own orders.

All settings can be changed via **Window settings (Ctrl+E)**.

You can add orders in the trading system using different ways (for details, see section 6.2.3). Orders parameters can be specified in an appropriate dialog box. You can use the parameters of an existing order as a template or set some new parameters.

Orders which, by some reasons, were not added into the trading systems are displayed in the **Unprocessed orders** area within the side panel. From there, you can reset their parameters and retry to add them into the trading system by executing **Repeat order** in the corresponding context menu.

The **Messages** window displays the messages returned by the trading system.

You can remove your order from the system by:

- executing the **Cancel order** command from the **Your orders/ requests** window or by doubleclicking the mouse left button on an active order;
- clicking the mouse left button on an active order in the Order-Book window in the orders panel.

Please note that you cannot remove orders added by others.

Chapter 4. How to start and how to finish working with trading terminal

This chapter overviews the following operations:

- signing in for the trading system and entering the trading system;
- connecting, stopping and reconnecting transport (communications protocol);
- transport statuses;
- finishing work with the application.

4.1. Application start and user sign in

To start working with the trading terminal place cursor over the  shortcut and double click the left mouse button. The application will start.

The transport connection window appears automatically upon the application start. It is also used for user signing in.

If needed, you can activate transport connection via the **File/ Connections/ Connect SPECTRA** command of the main menu. Please note, that some settings (desktop configuration settings, windows settings, etc.) can be made only when transport connection is not activated.

Until transport is not launched, the terminal tables will be empty. The transport connection is mandatory for maintaining trading operations or for viewing trading sessions.

4.2. Change password

Any user is able to change their password by themselves (having the transport connection established). To change a password, please use a dedicated window which can be evoked via the main menu item **File/ Change password**.

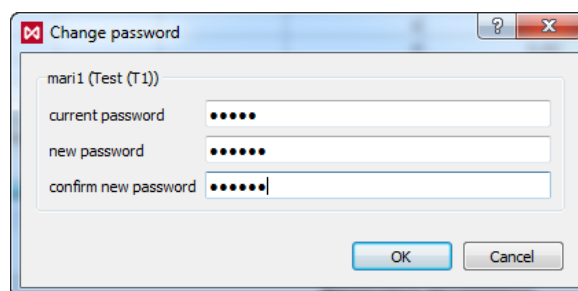

Fig. 4.1. Change password window

The first line contains the user login and transport connection profile (in brackets).

To set up a new password, please enter your current password into the appropriate entry field. After that, enter your new password twice into the appropriate entry fields. All password symbols will displayed as small black dots. Please note that your new password must contain not less than 5 symbols.

Press **OK** to apply your new password. Before applying, you will receive a warning message "Are you sure you want to change password?". Answer **Yes** to proceed with the password change, or **No** to cancel.

You can check the **Do not show next time** checkbox to disable the confirmation message.

You can specify the order adding confirmation message settings via the **Confirmation on password change** option in the **Settings/ Terminal settings** window, the **Main** section, **Confirmations** tab.

Press **Cancel** if you like to cancel the password change and keep your current password unchanged.

After the password has changed, you may proceed working with the application without restarting. You will be required to enter your new password on the next application start.

4.3. Transport connect

You can connect to the trading system using the following methods:

- by clicking the  button in the main instrument panel;
- by executing the **File/ Connections/ Connect SPECTRA** command of the main menu. Then, a user sign in window appears on the screen.

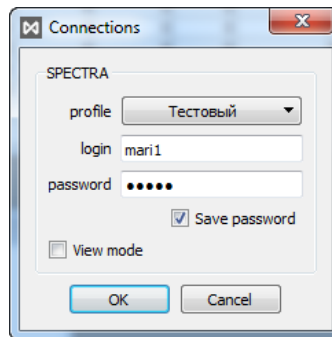

Fig. 4.2. User sign in window

Enter the user name and password into the appropriate fields (you can switch between fields by mouse cursor or by using the **Tab** key on keyboard). Please note that user names and passwords are provided by the system administrator, so that users cannot change them.

Tab. 4.1. User sign in window fields

Field name	Details
profile	The name of a resource to connect to, can be selected in the drop-down list. You can edit the profile list via the Settings/ Terminal settings command of the Transport section. To change transport profiles, select the Edit profiles command in the drop-down list. For detailed information about profiles see section 10.17.1.
login	User name of the trading participant provided by the administrator.
password	Password of the trading participant. Along with user name, it is provided by the administrator and cannot be changed by user.
Save password	Check this checkbox to make system remember your password. Otherwise, you will have to enter your password manually every time you need to sign in.
View mode	If the checkbox is active, you will be connect to the trading system without permission to add orders and make other trading operations.

To confirm transport connection, press **OK**.

To cancel transport connection, press **Cancel**.

When you save your user parameters (login and password), you can setup the automatic transport connection at terminal start. To do this, please check the **Autoconnect at startup** option via the **Settings/ Terminal settings/ Main**

main menu option in the **Main** section of the **Common** tab. After that, you will not receive the transport connection dialog at startup. Please note, that after the database cleanup procedure also deletes your login and passwords, so that you will need to enter a new pair in order to make the automatic connection option work.

4.3.1. Testing network connections

Once a network error occurs on establishing connection, a text button **Testing connection** will appear in the window **Connections**:

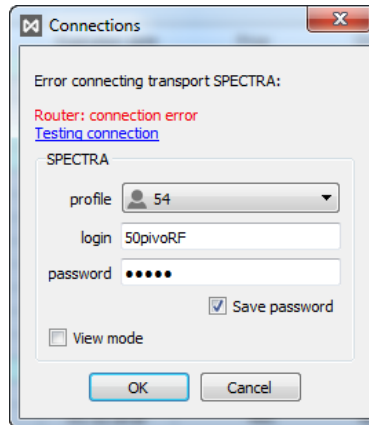

Fig. 4.3. The sign up window when a network error occurs

To test all available connections, press the text button **Testing connection** (**Settings/ Terminal settings/ Transport**). The testing results will be displayed in the window **Connections**:

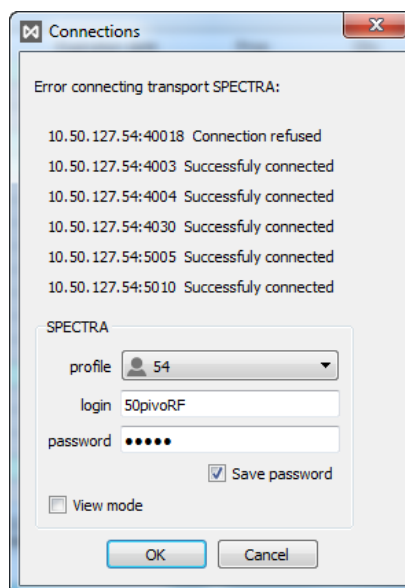



Fig. 4.4. Testing results window

According to the connection testing results, a user is able to select another available connection profile in the same window. Also, a user may close the window **Connections**, manually edit a connection profile settings, and then retry

to connect using the standard methods (the main menu item **File/Connections**, or button ).

4.4. Transport disconnect

You can disconnect transport by the following methods:

- by clicking the  button in the main instrument panel;
- by executing the **File/ Connections/ Disconnect SPECTRA** command of the main menu. Then, uncheck the checkbox next to the transport name by clicking the left mouse button. Every active checkbox indicates a connected transport.

After unchecking a checkbox, a confirmation message appears on the screen:

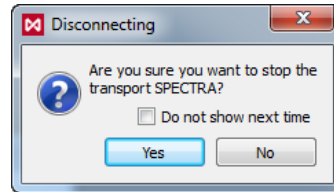

Fig. 4.5. Transport disconnect confirmation window

You can disable the transport disconnect confirmation. To do this, use one of the following methods:

- check the **Do not show next time** checkbox in the confirmation window - see fig. 4.5;
- Uncheck the **Transports disconnect confirmation** option in the **Settings/ Terminal settings/ Main/ Confirmations** menu.

To rollback the confirmation settings please check back the **Transports disconnect confirmation** option in the **Settings/ Terminal settings/ Main/ Confirmations** menu.

When your computer turns to the sleep mode, all connected transports get disconnected. After resuming from the sleep mode, the transport connection window automatically appears on the screen- see fig. 4.2.

4.5. Transport reconnect using another profile

If needed, you can reconnect transport using another profile. To do this:

- disconnect transport - see section 4.4;
- clear the database (the **Settings/ Terminal settings/ Database/ Clear** button) - see section 10.6;
- connect transport using another profile - see section 4.3.

4.6. Exit the application

You can exit the application using one of the following methods:

- by pressing the **Close** button in the top-right corner of the application window;
- by executing the **File/ Exit** command of the main menu;
- by pressing the **Ctrl+Q** key combination.

After that, a confirmation window appears on the screen:

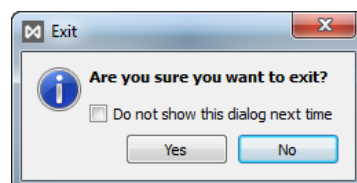

Fig. 4.6. Exit confirmation

If you are sure you want to exit, press **Yes**. Press **No** to cancel the exit and continue working with the terminal.

You can disable the exit application confirmation. To do this, use one of the following methods:

- Uncheck the **Application close down confirmation** option of the **Settings/ Terminal settings/ Main/ Confirmations** menu;
- check the **Do not show this dialog next time** checkbox in the **Exit** window - see fig. 4.6

To rollback the confirmation settings please check back the **Application close down confirmation** option in the **Settings/ Terminal settings/ Main/ Confirmations** menu.

4.7. Transport status

You can view the transport connection/disconnection log via the **File/ Connections/ Transport status** command of the main menu.

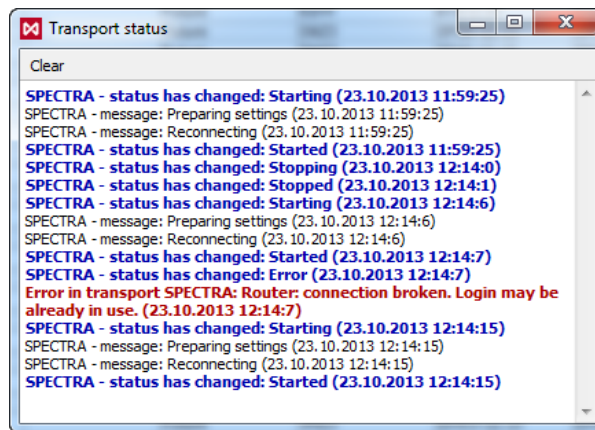

Fig. 4.7. Transport status

Each record in the **Transport status** window contains the transport name along with the transport current status information and the date and time of the record (in brackets).

Blue coloured records indicate status changes.

Black coloured records indicate system messages informing about the current events. Each record also contains the transport name and the date and time of the event.

Red coloured records indicate transport errors.

4.8. Disconnect

To provide extra stability, the system allows to setup the automatic reconnect option in case of any connection failure.

To setup the automatic reconnect option parameters, please use the **Reconnect automatically at disconnection** option via the **Settings/ Terminal settings/ Main** main menu item in the **Main** section of the **Common** tab.

If the option is enabled, the application will automatically reconnect to the server without asking for the user's login and password. By default, the option is enabled.

By default, the number of reconnect attempts is not limited. However, you can limit the number of attempts using the **Maximum connection attempts** option via the **Settings/ Terminal settings/ Main** main menu item in the **Main** section of the **Common** tab.

If the **Maximum connection attempts** option is enabled, the number of reattempts will be limited with the specified value. Also, the following window will appear on the screen:

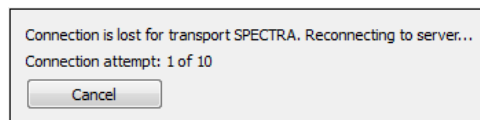

Fig. 4.8. Automatic reconnection to the server

If the **Reconnect automatically at disconnection** option is not enabled, the following window will appear on the screen:

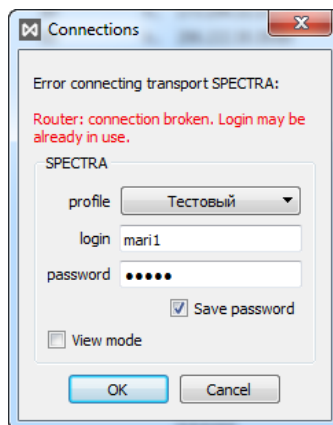

Fig. 4.9. The Connections window at disconnect

4.9. Abnormal application termination

In case of an error causing abnormal application termination (crash), the following window appears on the screen:

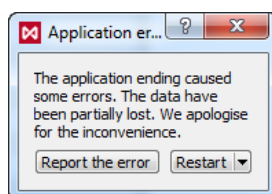

Fig. 4.10. Abnormal termination error message

To resolve the situation, you can do the following:

- simply close the window. The terminal will not be restarted;
- **Restart** the application by selecting the appropriate command in the **Restart** drop-down menu;
- **Restart with empty database** by selecting the appropriate command in the **Restart** drop-down menu. This command clears the terminal database before restarting it;
- **Restart with default profile** by selecting the appropriate command in the **Restart** drop-down menu. Please note that all user settings will be abandoned and the application restart with its default settings!
- **Do not restart now** by selecting the appropriate command in the **Restart** drop-down menu. The terminal will not be restarted. This point is similar to the first point;
- **Report the error**, by pressing the appropriate button. After this, the **Error report** window appears on the screen:

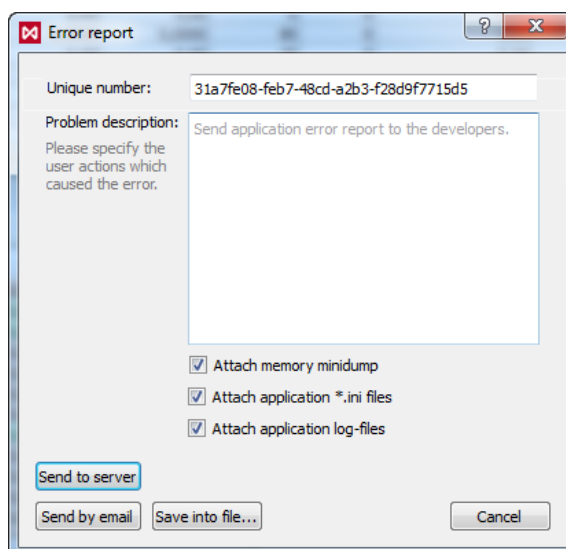

Fig. 4.11. Abnormal termination report

The crash reports are sent anonymously, so that every crash report contains its own **Unique number** to help identifying the problem later.

The **Problem description** field is filled in by user and contains detailed information about the reasons which caused the problem, steps to reproduce the problem and any other information of any kind which may be useful to understand the problem better.

Also, it is recommended to attach the following:

- memory minidump;
- application INI files;
- application log-files.

To attach the files please check the appropriate checkboxes. If the checkboxes are inactive, then no files will be attached to the report.

The memory minidump is sent anonymously and does not contain user logins, passwords or any other confidential data. Please do not forget to attach it if possible, as it really helps to investigate the roots of the problem.

You can send the crash reports in several ways:

- **Send to server** – after pressing this button, the report will be automatically sent to the server;
- **Send by email** – after pressing this button, the new e-mail message window appears on the screen; its **To** and **Subject** fields are filled in automatically. The **Subject** field contains the OS name along with the report ID which is equal to the **Unique number** - see fig. 4.11;
- **Save into file** - after pressing this button, an **EML** file is created, which can be sent as an e-mail message from any computer. User can change its name by default (**Crash**) to any other name.

Pressing the **Cancel** button closes the **Error report** window (fig. 4.11) and takes you back to the **Application error** window (fig. 4.10) without sending any crash report.

The **Error report** window can be evoked via the **Help/ Report application error** main menu item. This may be caused not only by abnormal termination, but by any other error. The difference from the case described above is that in this case no memory dump file is created, and the **Attach memory minidump** field is always disabled. Also, the error message does not contain its unique number.

Chapter 5. User interface

Thus chapter overviews the main interface elements of the trading terminal:

- main window;
- main menu;
- instrument panel;
- side panel;
- status line;
- workspace configuration;
- windows managing;
- general work practices;
- auxiliary dialog boxes.

5.1. Main window

The trading terminal is a multi-window application. After opening the main window, you can open one or more additional windows within it.

Therefore, you can create several groups of open windows at once and organize them as 'tabs' (see section 5.9.1). Only one tab can be active at a time, while the other tabs are inactive and hidden. When you open a new tab, its windows become visible and active, while the previously opened windows become hidden.

You can change tab windows and its position as you like.

The active window's header is marked in bold.

You can unpin additional windows from the main window and pin them back again, changing your workspace freely. Unpinned windows do not belong to any tab.

The main window consists of:

- main window title;
- main menu line;
- instrument panel (can be hidden);
- client workspace, containing groups of windows. User can vary position and content of each group and tab.
- side panel (can be hidden);
- status line.

The main window title displays the name of the current tab, the name of the current workspace and the trading system ID.

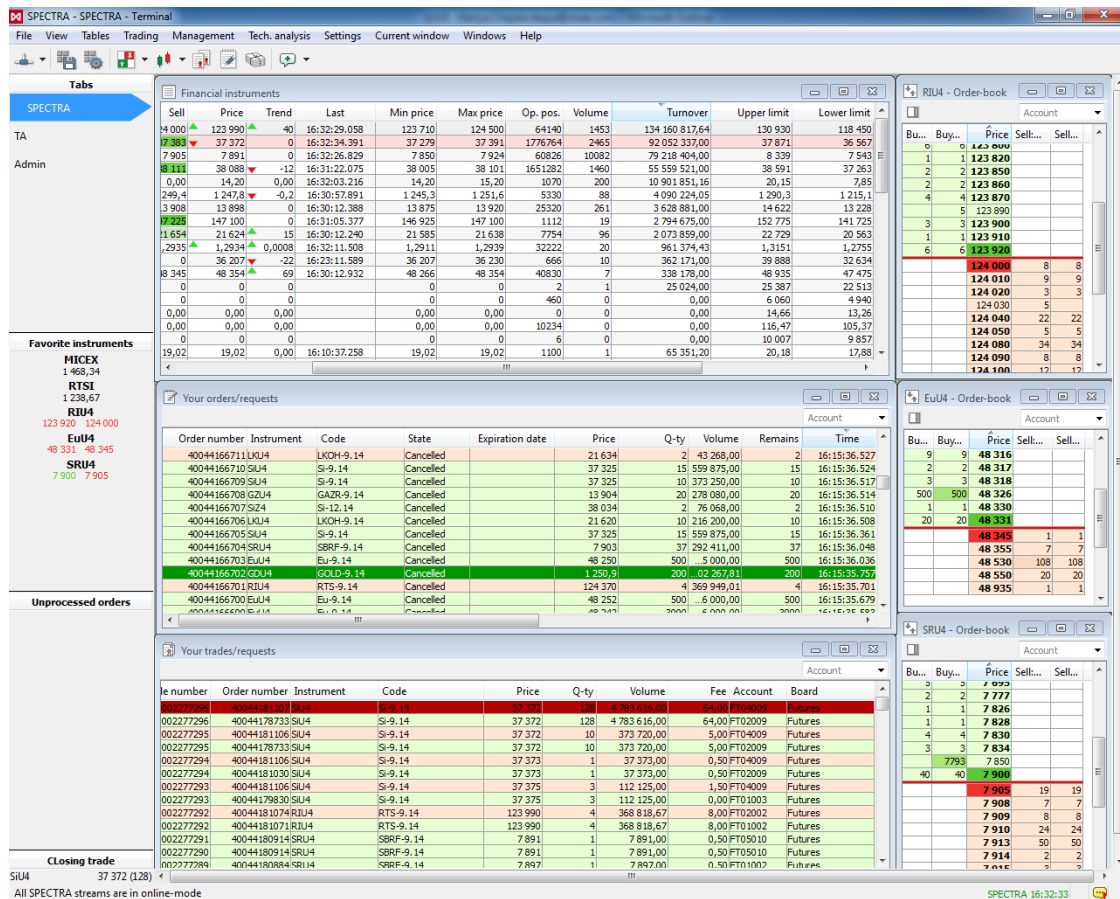

Fig. 5.1. Trading terminal main window

The status line displays information about the trading terminal current status - for details see section 5.5.

You can open more than one main windows at once by executing the **File/ New window** command or by pressing the **Ctrl+N** key combination. To switch from one main window to another:

- click left mouse button or make any other action in the window;
- click left mouse button at the appropriate icon in the taskbar in the bottom of the screen. Every main window is represented by its own icon in the taskbar.

Once you try to close a main window (if it there are more than one opened), a dialog box will appear on the screen, informing you that all opened tabs in this window will be lost. To confirm closing the main window press **Yes**, to cancel press **No**.

Main windows can be opened in the full-screen mode by executing the **View/ Full screen** command or by pressing the **Ctrl+Shift+F** key combination. Please note, that you should set the full-screen mode separately for each main window, if necessary.

5.2. Main menu



The application main menu allows to access all application functions and features. Please note that availability of some menu commands depends on selected user role and of plugins installed.

Some menu elements are created dynamically (for example, lists of open windows).

Hotkeys and key combinations right of the menu element name indicates the possibility of performing the same operation by using keyboard.

For detailed information about the main menu commands and corresponding drop-down menu commands and their see tab. 5.1.

Tab. 5.1. Main menu commands

Main menu command	Nested menu commands (2nd level)	Nested menu commands (3rd level)	Instrument panel icon	Hotkeys/key combinations	Details
File					The menu item is used for connecting transports, creating/restoring workspace configuration and adding/removing tabs.
	Connections				The section is used for managing connections to the trading floors.
		Connect SPECTRA			Connects the SPECTRA trading floor.
		Disconnect SPECTRA			This menu item becomes available when there is a transport connection established. The menu item line contains the transport name, profile name and the user login to disconnect.
		Transport status			Opens a transport status window.
	Change password				Sends a password change request
	Restore configuration				Restores workspace configuration.
	Save configuration			Ctrl+S	Saves the current workspace configuration.
	New window			Ctrl+N	Opens a new main window.
	New tab			Ctrl+T	Adds a new tab to the desktop.
	Close tab				Closes the current tab at the desktop.
	Exit			Ctrl+Q	Closes the trading terminal application.
View					
	Full screen			Ctrl+Shift+F	Opens the application in full-screen mode.
	On top of all windows			Ctrl+Shift+T	When the option is set, the terminal window is always located on top of all other windows. The option is valid only in the current work session. It automatically reset after restart of terminal.

Main menu command	Nested menu commands (2nd level)	Nested menu commands (3rd level)	Instrument panel icon	Hotkeys/key combinations	Details
	Show toolbar				Allows to show/hide toolbar under the main menu line.
	Show side panel			Ctrl+L	Allows to show/hide sidepanel.
	Information			Ctrl+I	Displays information about a selected instrument.
Tables					The main terminal windows.
	Financial instruments				Opens the Financial instruments window.
	Options board				Opens the Options board window.
	Sessions				Opens a list of trading sessions.
	News				Opens a list of news from various news sources.
	Your orders/ requests				Opens your orders window.
	Your trades/ requests				Opens your trades window.
	All trades/ requests				Opens all trades window.
	Order-book for instrument				Opens an Order-book for the selected instrument. The favorite instruments are displayed at the top of the menu.
		Favorite instruments		Ctrl+Alt+F	Opens a favorite instruments window.
		Select instrument			Opens an instrument selection window.
	RFS (active streams)				Opens a window that contains liquidity streams - on-demand auction.
Trading					The section contains the most frequent trading operations.
	Money				Opens a window, containing information about money positions for client accounts.
	Positions/ requests				Opens a window, containing information about instrument positions for client accounts.
	Positions by settlement accounts				Opens a window, containing information about positions aggregated by settlement accounts.

Main menu command	Nested menu commands (2nd level)	Nested menu commands (3rd level)	Instrument panel icon	Hotkeys/key combinations	Details
	Add order				Opens an empty form for adding orders.
	Request to NCC				Opens an empty form for adding request to NCC for a Clearing Participant which is not simultaneously a Trading Participant.
	Cancel orders				Mass order cancellation.
		Cancel all orders			Mass order cancellation according to the client or BF account specified.
		Cancel all buy orders			Mass buy order cancellation according to the client or BF account specified.
		Cancel all sell orders			Mass sell order cancellation according to the client or BF account specified.
	Messages				Opens an orders status messages window.
	Postponed orders				Opens the Postponed orders window, which allow a batch entry of orders.
	Dynamical order adding				Opens the Dynamical order adding window, which allow a dynamical entry of orders from csv -file.
	Errors and notifications				Opens the Errors and notifications window, which contains messages from the trading system for the current connection session.
	Administrator's messages			Ctrl+Alt+M	Opens the Administrator's messages window, which contains messages from the trading system administrator for the current connection session.
	Option calculator				Allows to work with the option calculator - analyze option strategy.
Management					The section contains operations that are included in the plugin Management .
	Market maker obligations for options				Opens the Market maker obligations for options window, which allows to monitor

Main menu command	Nested menu commands (2nd level)	Nested menu commands (3rd level)	Instrument panel icon	Hotkeys/key combinations	Details
					the implementation of market-making obligations.
	Market maker obligations for futures				Opens the Market maker obligations for futures window, which allows to monitor the implementation of market-making obligations.
	Market maker obligations for IQS options				Opens the Market maker obligations for IQS options window, which allows to monitor the implementation of market-making obligations.
	Market maker obligations for IQS futures				Opens the Market maker obligations for IQS futures window, which allows to monitor the implementation of market-making obligations.
	Limination				Opens the Limination window, which allows to set and manage limits and prohibitions.
	Settlement account assets				Opens the Settlement account assets window.
	Manage BF parameters				Opens the Manage BF parameters window, which contains managing parameters for limits and collateral risks calculation for BF level.
	Manage client parameters				Opens the Manage client parameters window, which contains managing parameters for limits and collateral risks calculation for BF level.
	Prohibitions				Opens the Prohibitions , window, which allows to set and manage prohibitions.
	Option exercise rules				Open the Option exercise rules window, which allows to edit exercise rules for options.
	Users				Open the Users window, which allows to activate/ deactivate users.
	SMA-user order verification				Open the SMA-user order verification window, which allows to choose the type of

Main menu command	Nested menu commands (2nd level)	Nested menu commands (3rd level)	Instrument panel icon	Hotkeys/key combinations	Details
					verification for SMA-user orders.
	Settlement Account assets (clearing)				Open the Settlement Account assets (clearing) window.
	Client assets (clearing)				Open the Client assets (clearing) window.
	Collateral breakdown				Opens the Collateral breakdown window.
	Requests to withdraw and deposit funds				Opens the Requests to deposit/withdraw funds window.
	Position profiles transfer requests				Opens the Position profiles transfer requests window. The window Position profiles transfer requests is designated exclusively for Settlement accounts belonging to the Unified Collateral Pool.
	Collateral transfer requests				Opens the Collateral transfer requests window. The window is used to transfer collateral between Settlement accounts or between Markets with in the same Settlement account.
Tech. analysis					The section is used for working with charts.
	Open chart				Opens a window containing charts for a selected instrument. The upper side of the menu contains the selected favorite instruments.
		Favorite instruments		Ctrl+Alt+F	Opens a favorite instruments window.
		Select instrument		Alt+C	Opens an instrument selection window.
	Indicator editor			Shift+E	Opens the Indicator editor window, which is used for editing indicators and functions.
	Manage TA data				Import/export the technical analysis data
		Import		Shift+I	Import of data, received from external sources.

Main menu command	Nested menu commands (2nd level)	Nested menu commands (3rd level)	Instrument panel icon	Hotkeys/key combinations	Details
		Exort		Shift+X	Export of data saved by the technical analysis plugin.
		Edit		Shift+D	TA saved data editor.
Settings					Trading terminal settings.
	Manage configurations				Opens the Workspace configurations window, which allows to manage workspace configurations.
	Favorite instruments			Ctrl+Alt+F	Opens a favorite instruments window.
	Restore default settings				Resets all user settings and restores the default settings.
	Terminal settings			Ctrl+,	Opens a terminal settings window.
Current window					The section is used for managing the current window.
	Pin/ unpin window			Alt+W	Pins a window in the tab or unpins it from the tub.
	Close window			Ctrl+W	Closes the current window.
	Move to tab				Moves the current window to another tab from the drop-down list.
	Copy to clipboard				Copies contents of the current window into buffer.
	Export				Exports contents of the current window into a TXT file.
	Dynamical export				Periodically (at a specified interval) exports contents of the current window into a TXT file.
	Save by default				Saves the current window settings as default settings.
	Restore to default				Restores default settings for the current window.
	Window settings			Ctrl+E	Opens a current window settings dialog box.
Windows					The section is used for working with open windows. The upper The upper side of menu contains a list of all open windows (in all tabs). You can switch between the open windows by selecting them in the list.

Main menu command	Nested menu commands (2nd level)	Nested menu commands (3rd level)	Instrument panel icon	Hotkeys/key combinations	Details
	Next window			Ctrl+Tab	Switching between windows – Next window.
	Previous window			Ctrl+Shift+Tab	Switching between windows – Previous window.
	Arrange windows side by side				Arranges windows side by side, covering the whole desktop. This menu item is available only for the tabs with windows.
	Cascade windows				Automatically cascades windows – some windows become partly overlapped with another ones. This menu item is available only for the tabs with windows.
Help					The section contains information about the application.
	Help				Opens the help text.
	About				Displays information about the application including its version number.
	About plugins				Opens the list of installed plugins. Information includes file names, file locations, developers' names and brief descriptions.
	About Qt				Displays information about the development language.
	Context help			F1	Opens a window with context help system.
	Report application error				Opens the Report application error window, which allows to enter a description of the error message and send it to the developer. Detailed description - see section 4.9.
	Open log file				Opens the folder, containing the terminal log-file.
	Plaza2 log file			Ctrl+Alt+L	Opens the Plaza2 log-file.

5.3. Instrument panel



Fig. 5.2. Instrument panel











The instrument panel is situated right below the main menu line. It contains icons of some of the frequently used commands, which can also be executed via the application main menu.

You can switch the instrument panel on and off via the context menu by using the **Show toolbar** checkbox (check it to display the instrument panel and uncheck to hide the instrument panel).

You can open the context menu by clicking right mouse button over the instrument panel.

If the instrument panel is hidden, you can access the context menu by clicking right mouse over the main menu line.

Tab. 5.2. Instrument panel items

Instrument panel icon	Main menu command	Hotkeys/key combinations	Details
	File/ Connections/ Connect or Disconnect SPECTRA		Connects/ Disconnects transport.
	File/ Save configuration	Ctrl+S	Saves the current workspace configuration.
	Settings/ Manage configurations		Opens the Manage configurations window.
	Tab/ Order-book for instrument		Opens the Order-book window.
	Tech. analysis/ Open chart		Opens the Open chart window containing chart for the selected instrument.
	Tab/ (Your trades/ requests)		Opens/makes active the Your trades/ requests window.
	Tab/ (Your orders/ requests)		Opens/makes active the Your orders/ requests window.
	Trading/ (Positions/ requests)		Opens/makes active the Positions/ requests window.
	Trading/ Postponed orders		Opens the Postponed orders window.
	Trading/ Add order		Opens the Add order window.

5.4. Side panel

You can open a side panel in the left side of the application workspace.

You can show or hide the side panel by the **View/ Show side panel** command of the main menu or by pressing the **Ctrl+L** key combination.

You can select the side panel contents via the **Settings/ Terminal settings** main menu item (in the **Side panel** section), where the option name corresponds to the section name in the side panel. Therefore, you should turn on the option to add it to the side panel and turn it off to remove from the side panel.

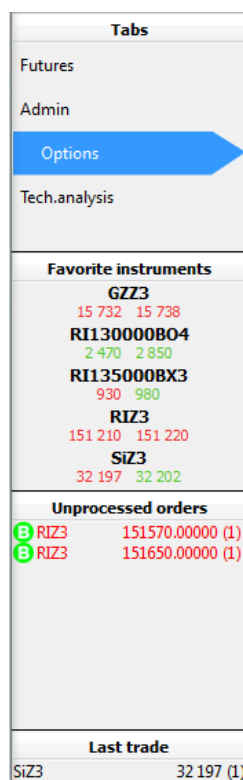

Fig. 5.3. Side panel

The side panel consists of the several sections:

- **Tabs** – displays shortcuts for all tabs open in the current main window. Here you can switch between tabs by clicking left mouse button on them. You can change the tabs order in the section; to do this, drag and drop a selected tab into a new position. The currently active tab is marked with blue arrow.

By clicking the right mouse button at a tab, a context menu appears with the following commands:

- **Rename** - changes tab name;
- **Clone** - allows to clone the tab including its name and all its windows (you can change the tab name before clicking **OK**). You can add up to 9 tabs in the same main window; after that, the **Clone** command becomes inactive.
- **Close tab** - closes the active tab;
- **New tab** - opens a new tab. You can add up to 9 tabs in the same main window; after that, the **New tab** command becomes inactive;
- **Favorite instruments** – displays list of the favorite instruments. The list includes only the instruments traded in the current session. There are the best sell price and the best buy price indicators below each instrument where green colour indicates price increase and red colour indicates price decrease. You can add more instruments to the list by dragging-and-dropping them from the **Financial instruments**, **Options board**, **All trades/ requests**, **Your trades/ requests**, **Your orders/ requests** and **Order-book** windows. Negotiated instruments can not be added into the list of **Favorite instruments**. Also, you can change the instruments order in the list again by dragging-and-dropping them from one position to another. An additional ID within brackets next to the instrument ID means that the selected instrument belongs to the board **Nearby futures contracts** - for details see section 5.11.2.1. The **Favorite instruments** list allows to select more than one record using the **Shift** and **Ctrl** key combination. Some actions may be applied to groups of instruments. By clicking the right mouse button at an instrument, a context menu appears with the following commands:
 - **Add order** - adds order for the selected instrument into the trading system. Also, you can add orders for the selecting instrument by double clicking the left mouse button on it in the list. In the context menu, this command

is market by bold font as the default command. The menu item becomes available only when a single instrument selected.

- **Open all trades** - opens the **All trades/ requests** window with the filter applied according to the selected instruments;
 - **Open Order-book** - opens an Order-book window for the selected instrument. The menu item becomes available only when a single instrument selected.
 - **Add chart** - creates a graphical chart for the selected instrument. If you selected more than one instrument in the **Favorite instruments** list, than chart for each instrument will be opened in a separate TA window.
 - **Add volatility curve** - adds volatility curve into a separate window. This menu item is available for option contracts only after selecting a single instrument;
 - **Information** - opens the **Information** window for the selected instruments (section 6.1.1). The window contains information for all selected instruments. When there are some different ones selected such as indices, futures and options, the window will contain the same parameters for all the instrument in accordance with the parameters set for the first selected instrument.
 - **Add to favorites** - adds a new instrument into the list of the favorite instruments;
 - **Remove** - removes the selected instruments from the list of the favorite instruments;
 - **Settings...** - opens the **Favorite Instruments** window.
 - **Unprocessed orders** – the section contains unprocessed orders, i.e. the orders which have not been added into the trading system for some reasons (for example, if an order price is out of price limits, this order will not be processed). By clicking the right mouse button at an instrument, a context menu appears with the following commands:
 - **Repeat order** – opens a window containing properties of the selected order. Here you can edit the order parameters and try to repeat adding this order;
 - **Cancel order** – the order will be cancelled and removed the order from the list of unprocessed orders. This menu item is available for the orders, for which replies were received;
 - **Remove from list** - the order will be removed from the list of unprocessed orders. This menu item is available for the orders, for which replies were not received. Please note, that the order will not be cancelled;
 - **Cancel all orders** – clears the list of unprocessed orders.
- This section also contains a button which allows to remove transactions which are left in transport queue for some reason. Please note that the button is not shown when the transport queue is empty.
- **Last trade** – this section contains parameters of the last matched order: instrument code, trade price and quantity of instrument in the trade (in brackets), or the last calculated index or fixing value.

5.5. Status line

The status line is situated at the bottom of the application workspace.

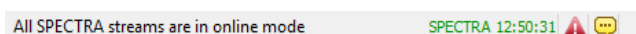



Fig. 5.4. Status line

The status line contains the following information:

- all available transports: green colour indicates connected transport and black colour indicates disconnected one;
- server's time;

- connection error messages for the current connection session. Once a connection error occurs, the  icon appears in the status line. By clicking on the icon, the **Errors** message appears on the screen – see section 6.7.2.
- if the trading system administrator sends a message to the system, then the  icon appears in the status line. By clicking on the icon, the **Administrator's messages** window appears on the screen - see section 6.7.1.

5.6. Main functional windows

Functional windows are the main elements of the trading terminal user interface. Functional windows are used for viewing information and/or to interact with it.

Tab. 5.3. Trading terminal functional windows

Window name	Main menu item	Details
Financial instruments	Tables/ Financial instruments	The window contains the complete list of instruments traded in the current trading session, along with the instruments parameters.
Options board	Tables/ Options board	The window contains the complete list of options traded in the current trading session.
Sessions	Tables/ Sessions	The window contains general information about the current and the previous trading sessions.
Your orders/ requests	Tables/ (Your orders/ requests)	The window contains the complete list of orders added by you during the current trading session.
Your trades/ requests	Tables/ (Your trades/ requests)	The window contains the complete list of user trades for the current session.
All trades/ requests	Tables/ (All trades/ requests)	The window contains the list of all trades for the current session.
Order-book	Tables/ Order-book for instrument	The window displays all orders for the current session as Order-book. This window is used for adding orders into the trading system.
Money	Trading/ Money	The window displays information about user money positions for every account.
Positions/ requests	Trading/ (Positions/ requests)	The window contains user instrument positions for every account. This window is also used for adding exercise orders for options.
Messages	Trading/ Messages	The windows displays the trading system messages returned in reply to user actions. Error messages are returned in case of any failure in adding orders.
Management	Management/ Management	The window displays clients limits. You can change the limits from the context menu in if you have sufficient rights.
Tech. analysis	Tech. analysis/ Open chart	The window is used for creating graphical charts.
Postponed orders	Trading/ Postponed orders	The postponed orders window is used for arranging a pool of postponed orders.
Options calculator	Trading/ Options calculator	The option calculator window helps to analyse option strategies.

5.7. Workspace configuration

The workspace configuration is the whole of the application main window settings, quantity of the application main windows including their contexts, tabs, unpinned windows, as well as every window preferences and settings. Users can create several workspace configurations and activate each of them when necessary.

The workspace configuration loaded at the first application start is the basic workspace configuration. If, for any reason, you do not like it, you can create your own workspace configurations and save them for later usage.

The **Configuration management** window contains the list of default and user created workspace configurations.

The active workspace configuration is always marked in bold in the list (fig. 5.5).

You can manage workspace configurations using the **Settings/Configuration management** main menu item.

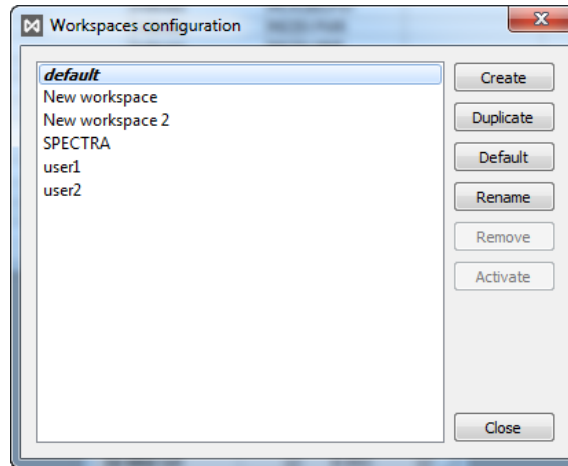

Fig. 5.5. Workspace configurations management

Tab. 5.4. The workspace configurations management buttons

Button	Details
Create	The button allows to create a new workspace configuration by opening an appropriate window - fig. 5.6. For details see section 5.7.1.
Duplicate	The button allows to clone an existing workspace configuration. The (fig. 5.6) window appears on the screen, where you should enter the name of a new configuration. By default, the system offers the name of the parent configuration with the clone number added.
Default	The button allows to create a workspace with a default configuration. The (fig. 5.6) window appears on the screen, with the default configuration name 'SPECTRA'. The configuration name can be changed by user.
Rename	The button allows to rename configurations in the list. The (fig. 5.6) window appears on the screen, where you can enter a new configuration name and press OK .
Remove	The button allows to remove a selected configuration from the list. Before removing, a warning message appears on the screen: 'Are you sure you want to remove the configuration "name"?' To confirm press Yes , to cancel press No .
Activate	The button allows to make the selected configuration active.
Close	The button closes the configurations management window.

By default, all the changes you make to the workspace configuration during you work with the terminal are saved automatically. If needed, you can turn on the automatic workspace configuration saving option by selecting the **Save the current workspace configuration at exit** command, which can be found at **Settings/ Terminal settings** in the **Main** section in the **Main** tab. If the automatic saving option is not set, the default workspace will be loaded at the next terminal startup.

5.7.1. New workspace configuration

You can create a new workspace configuration via the **Settings/ Manage configurations** main menu item, by pressing the **Create** button. A window appears on the screen:

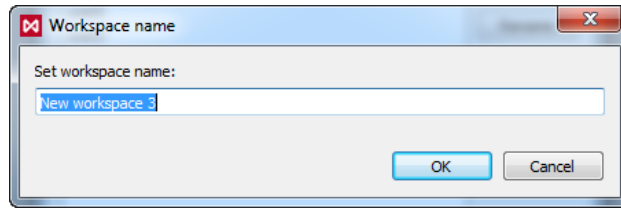

Fig. 5.6. Creating new workspace configuration

In the window, you should set the new configuration name.

If the configuration name already exists, a warning message appears on the screen: 'A workspace with this name already exists'; in this case, you should enter another name. You cannot overwrite the existing configurations.

Press **OK** to add the new configuration into the workspace configurations list.

Press **Cancel** to close the window without saving any changes.

5.7.2. Saving configurations

You can save the active configuration by the following methods:

- via the **File/ Save configuration** main menu item;
- by pressing the **Ctrl+S** key combination.

The active configuration will be saved under its current name. The current name of the active configuration is displayed in the main window title.

5.7.3. Restoring configuration

You can restore the previous configuration via the **File/ Restore configuration** main menu item, without any changes you made during your work with the terminal. Please note, that after you saved any of your changes, you will not be able to restore the previous configuration.

5.7.4. Restore default settings

The **Settings/ Reset to default** main menu item allows to reset all user settings and restore the default settings. All user created workspace configurations will be deleted. The workspace configuration list (**Settings/ Manage configurations**) will contain only the default workspace configuration.

You will have to restart the terminal application to reset user settings. Before restarting, the warning message dialog will appear on the screen. Press **Yes** to confirm reset, or **No** to cancel.

5.8. Basic configuration

The workspace configuration loaded at the first application start is the basic workspace configuration set by default (with the active side panel). You can change the configuration later according to your needs.

Attention, please!

Please note, that, according to some filters applied, not all information is displayed in the basic workspace configuration. To view and change filters settings please use the **Window settings** context menu item - see section 5.10.4.1.

You can also setup the column contents in tables via the **Window settings/ Columns** menu item - see section 11.3.

The Order-book windows opened in different tabs may have configurations different from the default configuration. Therefore, every time you open a new Order-book window, it may look differ from an already opened default Order-book

window. By default, every new Order-book window opens in the default mode with fixed center. The One-Click mode is not active by default.

5.9. Windows management

The section overviews methods of managing the application workspace:

- tabs;
- unpinned windows;
- windows arrangement;
- switching between windows;
- windows management.

5.9.1. Tabs in the workspace

The tabs allows to group windows in the workspace to help switching between one windows group to another. Every open window belongs to a tab except unpinned windows - see section 5.9.2.

After you switched to a tab, all its windows become visible, while all other windows (belonging to other tabs) hide.

You can open up to nine tabs in the same main window at one time.

There are two types of tabs:

- window tabs – see section 5.9.1.2;
- panel tabs – see section 5.9.1.3.

The tabs type is specified for all tabs in the application, but you can change it later, if needed. After applying the changes, all opened tabs will be changed to the newly set type. The panel tabs is the tab type set by default; To change it, use the **Settings/ Terminal settings/ Main/ View** main menu item, the **Use tabs with** option.

5.9.1.1. Actions with tabs

You can switch between the opened tab by:

- clicking shortcuts in the side panel;
- pressing the **Ctrl+1**, **Ctrl+2**, etc. key combinations. You can find the necessary key combination in the pop-up tooltips by moving mouse cursor on tabs - see fig. 5.3.

You can do all the possible actions with tabs from the context menu by clicking tab shortcut in the side panel:

- **Rename** – opens a window. Enter a new tab name and press **OK**;
- **Clone** – allows to clone the tab including its name and all its windows (you can change the tab name before clicking **OK**). You can add up to 9 tabs in the same main window; after that, the **Clone** command becomes inactive;
- **Close tab** – closes the selected tab. Before closing, a warning message appears on the screen: *'Are you sure you want to close the tab? All windows in the tab will also be closed'*. Press **Yes** to close the tab including all its windows, or **No** to continue working with the tab and its windows;
- **New tab** – allows to create a new tab by entering its name and pressing **OK**. You can open up to 9 tabs in the same main window; after that, the **Clone** command becomes inactive;

The new tab can be open by

- executing the **File/ New tab** command of the main menu;
- by pressing **Ctrl+T**,
- by executing the **New tab** command of the context menu in the side panel (the **Tabs** area).

You can close the tab:

- by executing the **File/ Close tab** command;
- by executing the **Close tab** command of the context menu in the side panel (the **Tabs** area).

5.9.1.2. Window tab

In this type of tabs, additional window can be situated randomly, even overlapping each other.

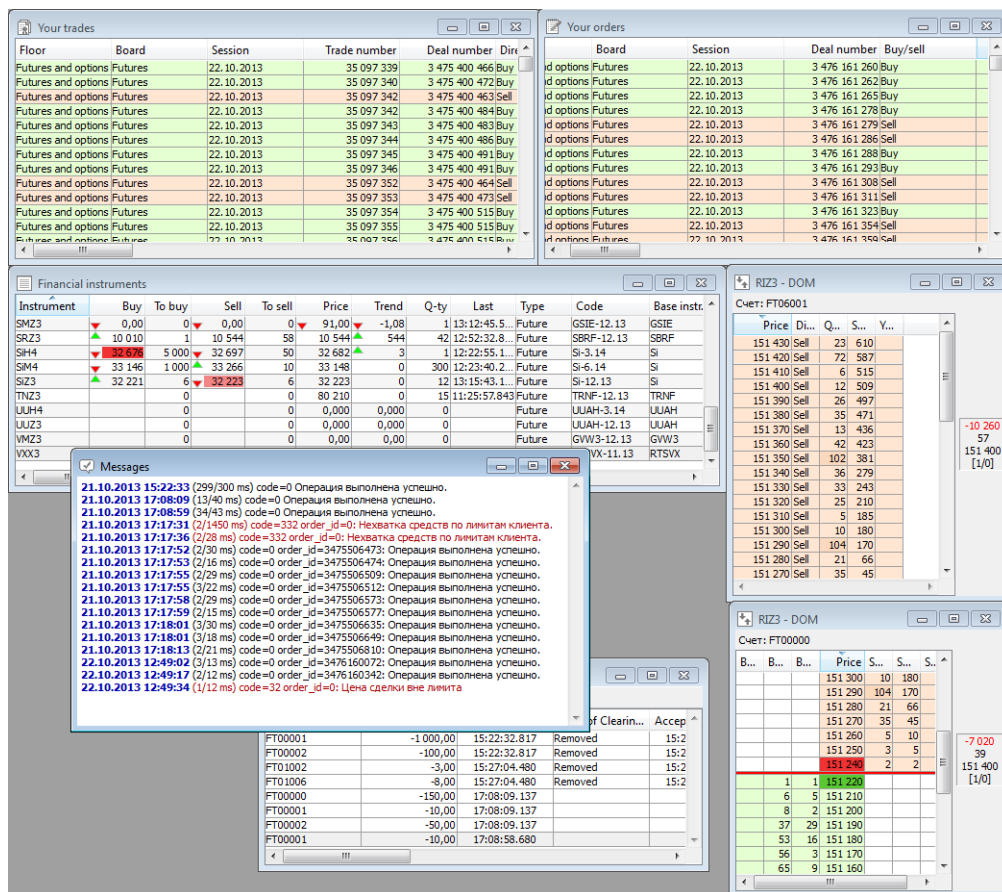

Fig. 5.7. Window tab

When opening, a window is placed to a random area of the tab; it can be later moved to another area.

To move a window, drag and drop its title using the right mouse button..

You can also change a window's size. To do this, place mouse cursor at the window border (the cursor will change its shape to double-arrow), then press the left mouse button and drag to maximize or maximize the window. You can change size of any open window independently from other windows' sizes.

The other way to manage additional windows is to use the context menu; to open it, click right mouse button at the additional window title:

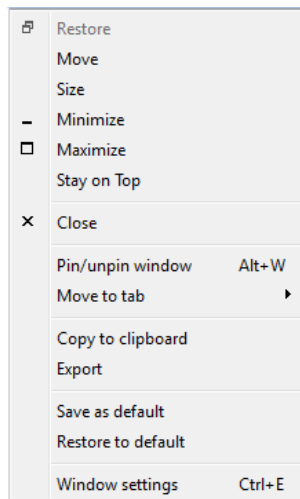

Fig. 5.8. Context menu for additional window

By checking the **Stay on Top** menu item, you will force the current window to always stay on top. To do this, click the left mouse button on the menu item.

There are two additional settings in the **Windows** main menu item, which are used for the window tabs only. They allow to quickly arrange windows in tab (see section 5.9.3):

- **Arrange windows side by side** – arranges windows side by side;
- **Cascade windows** – arranges windows by putting them in a single stack, leaving their titles visible.

5.9.1.3. Panel tabs

In the panel tabs, the additional windows always take all possible place.

The screenshot displays three overlapping window tabs in a financial software application:

- Financial instruments:** A table with columns: Price, Trend, Last, Min price, Max price, Op. pos., Volume, Turnover, Upper limit, Lower limit. It shows data for various instruments with prices ranging from 57,295 to 108,440.
- All trades/requests:** A table with columns: Trade number, Instrument, Code, Price. It lists trades for instrument SIM7 with prices between 58,219 and 58,264.
- Your orders/requests:** A table with columns: Order number, Instrument, Code, State, Exp. It shows active orders for instruments like MXM7, RI115000BF7, GZM7, SIU7, and EDM7.
- Positions/requests:** A table with columns: Account, Instrument, Code, Opening..., Bought, Sold, Position, Average, Total, Variation ma. It shows positions for accounts FT05010 and FT07002 across various instruments.

Fig. 5.9. Panel tabs

To move a window within the tab, click its title with the left mouse button and drag to an area you need; its borders will be adjusted automatically to fit the window. Then the window will take all possible area between opened windows and borders of the workspace.

To change the window size place the mouse cursor at the border between two windows (the cursor will change its shape to double arrow). Press the left mouse button and drag to maximize or maximize the window. Changing size of one window will automatically affect to the neighbor windows sizes.

You can dock windows horizontally and vertically, one to another, within the same tab.

In the panel tabs, additional windows can form groups of windows overlapping each other; to activate a window you should click its shortcut in the bottom of the group. To form a group, drag one window over another, until a frame appears around the recipient window, then release the left mouse button. The upper window will be represented as tab in the lower window. To separate window from the group click the window title and drag it to an area you need.

You can open a new window as a tab belonging to an already opened window. It means, that there is no need to manually move it. For more details see section 5.9.4.6

5.9.2. Unpinned window

Unpinned windows do not belong to any tab, so you can move them to any area within the workspace independently of other windows. Also, you can change their sizes freely, according to your needs.

Unpinned window is displayed in the taskbar as a standalone application.

You can unpin window using the following methods:

- via the **Current window/ Pin/unpin window** main menu item;

- via context menu item **Pin/unpin window** opened on title line of window;
- by pressing the **Alt+W** key combination.

You can unpin window to a tab using the following methods:

- via the **Current window/ Pin/unpin window** main menu item;
- via context menu item **Pin/unpin window** opened on title line of window;
- by pressing the **Alt+W** key combination.

Attention!

In Linux operating systems, you can pin/unpin windows by using the **Pin/unpin window** commands of menu or by pressing the **Alt+W** key combination.

Every unpinned window properties are equal to that of the standard window in the operating system you work in, so that any action applicable to the standard window can be applied to unpinned windows as well.

An unpinned window may become hidden under other windows. You can find a window you need via the **Windows** main menu item, by selecting the window you need in the list of the opened windows. Click it to make it active and visible.

For your convenience, every unpinned window has the menu line which is totally equal to that of the main window – see fig. 5.10. Displaying the menu bar in the free window is configured with the option **Show menus in unpinned windows** (the **View** tab of the **Main** section of main menu item **Settings/ Terminal settings**).

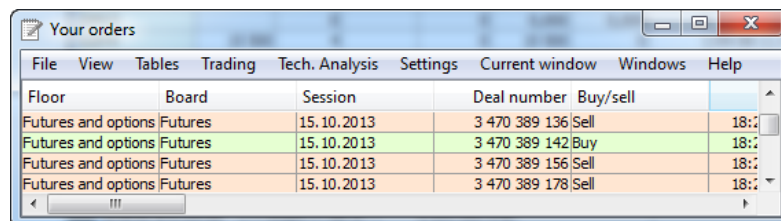

Fig. 5.10. Menu line in unpinned window

5.9.3. Arranging windows

You can arrange windows manually, by moving every window separately, dragging it with mouse to the area you need.

For window tabs, some new menu items appear in the **Windows** main menu item. They allow to automatically arrange windows in tabs, making the process quick and easy:

- **Arrange windows side by side** – arranges windows side by side;
- **Cascade windows** – arranges windows by putting them in a single stack, leaving their titles visible;
- **Align windows vertically** – arranges windows vertically, one under another;
- **Align windows horizontally** – arranges windows horizontally, one next to another.

The automatic arrangement will be applied only for the tab it was launched from, and does not affect windows.

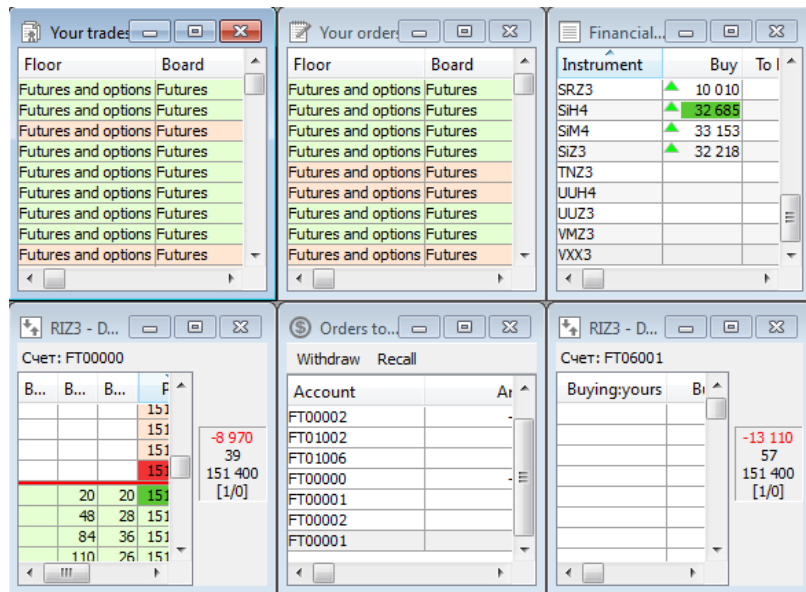

Fig. 5.11. Windows arranged side by side

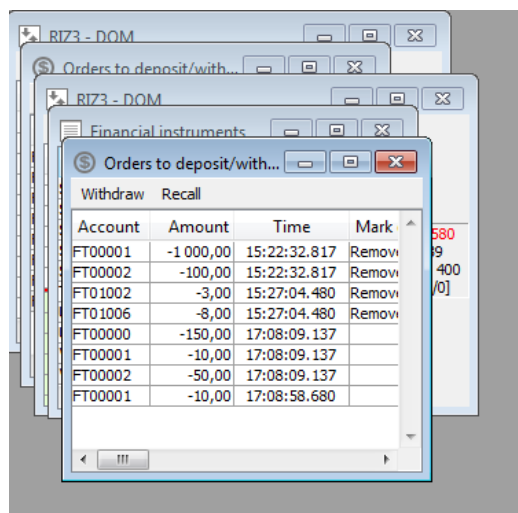

Fig. 5.12. Cascaded windows

5.9.4. Managing active window

Active window is the window which is now visible and situated on the top.

You can manage the active window by the following methods:

- by clicking commands in the **Current window** main menu item:

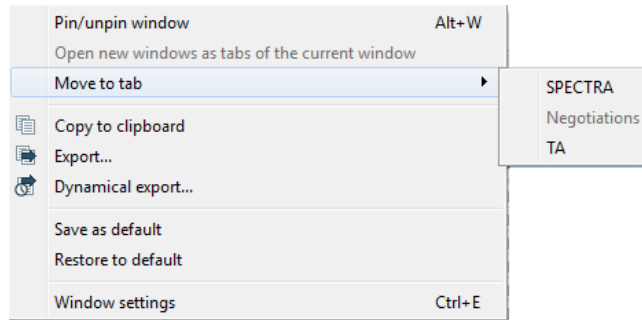





Fig. 5.13. Menu - Active window

- by clicking the icons in the window title line: , , , ;
- by clicking the context menu commands (opened on the window title line) or with menu opened by button (icon of window) in the upper left corner of the window:

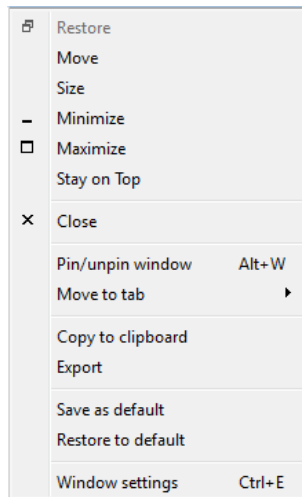



Fig. 5.14. Context menu, window title line

The following commands in the bottom of the context menu (fig. 5.13) are common to the context menus for all windows-see Chapter 11:

- **Copy to clipboard;**
- **Export;**
- **Dynamical export;**
- **Window settings.**

5.9.4.1. Minimize window

You can minimize a window by the following methods:

- by clicking the the **Minimize window** menu item of the menu opened by button in the upper left corner of the window. This menu item is available only for the window tabs. You cannot minimize windows in the panel tabs;
- by clicking the  icon;
- by clicking the **Minimize** menu item of the context menu (window title line).



After that, the window will be minimized to a shortcut in the taskbar. This minimized window is visible only in the tab it has been pinned to. The shortcut displays the window name and the buttons, which allow either to maximize the window or close it .



Fig. 5.15. Minimized windows

5.9.4.2. Maximize window

You can maximize window by the following methods:

- by clicking the appropriate window icons:  for the full screen mode or  for the windowed mode;
- by clicking the **Maximize** menu item of the context menu (window title line). The window then will be maximized in the full screen mode;
- by clicking the **Restore** menu item of the context menu (minimized window title line). The window then will be restored in the previous mode, either full screen or windowed;
- by clicking the **Current window/ Maximize window** menu item of the main menu. This menu item is available only for the window tabs. You cannot maximize windows in the panel tabs.

5.9.4.3. Move window

You can move a window from one tab to another by the following methods:

1. By clicking the **Current window/ Move to tab** menu item; in the sub-menu, select a tab to move the window in. Please note, that you can move only the active window.
2. By setting window as 'unpinned':
 - unpin window - see section 5.9.2;
 - open the tab you want to move the window in;
 - pin the window to the open tab - see section 5.9.2.

You can move windows within the active tab by the following methods :

- by clicking window title line with the left mouse button and dragging it to the area you need;
- by clicking the **Move** menu item of the context menu (window title line). After clicking, move the window to the area you need using your mouse (without pressing any mouse button), then click the left mouse button to fix the window in the new area.

5.9.4.4. Change window size

You can change window size by the following method:

- move your mouse cursor to a window border; the mouse cursor then will change its shape to double-arrow;
- press left mouse button and drag the window border, then release the left mouse button;
- the window then will be fixed in the size you need.

Changing size of a window also affects the neighbour windows sizes.



5.9.4.5. How to force window to stay on top

It is possible to force a window to always stay on top, even if it is not active. To do this, click the **Stay on Top** menu item of the context menu (window title line); the menu item will become checked. Uncheck the menu item to switch the window back to the previous mode .

5.9.4.6. Opening new windows as tabs

If you use the desktop configuration with panels, every new functional window opens as a tab of an already opened window. You can set a window as the dock area for new windows:

- via the icon  in the window's header;
- via the **Set dock area for new windows** context menu item opened from the current window's header;
- via the **Current window/ Set dock area for new windows** main menu item.

The dock area is marked with the icon . Please note that this window is not necessary the current window! If the current window is marked with , it means that new windows will be opened in another window which had been set as the dock area.

5.9.4.7. Close window

You can close a window by the following methods:

- by clicking the appropriate icon in the window title line - ;
- by clicking the **Close** menu item of the context menu;

5.9.4.8. Save and restore window configuration

You can save the current window configuration as default by clicking the **Current window/ Save as default** menu item of the main menu. When saving the window configuration, its size, location, appearance, filter and sorting settings are saved as default. After that, all windows of that type will obtain the same settings as the default window.

Click the **Current window/ Restore to default** menu item to restore the default window configuration.

5.9.5. Switch between functional windows

You can switch between open functional windows by the following methods:

- by finding the needed window visually on the screen; to make it active, click the left mouse button on it;
- by finding the needed window name in the **Windows** menu element of the main menu; to make it active, click the left mouse button on it.
- by pressing the **Ctrl+Tab** or **Ctrl+Shift+Tab** key combination. After pressing one of these key combination, a window will appear on the screen, displaying list of all open windows in every tab. Hold the **Ctrl** key pressed and press **Tab** to switch between the open windows one by one according to the list order. The next selected window in the list will become active automatically.
- by clicking the **Windows/ Next window** or **Previous window** main menu items. These commands are used to switch windows one by one, without preselecting them in any list.;
- by clicking the left mouse button on a window shortcut (if the window belongs to a window group). Please note, that you can create such window groups only when working with panel tags.

5.10. General work practices

This chapter overviews the general work practices with the trading terminal:

- editing fields;
- sorting data;
- context-based searching;
- filtering.

5.10.1. Editing fields

The way of editing fields depends on the field type.

If there is a  button in the right side of the field, than the field value can be selected in the drop-down list.

If the field contains a text string or a value:

- switch the field to the edit-mode by clicking on it;
- enter a text or a value you need using keyboard.

You can change the field value by using the  box in the right side of the field. The value right to the buttons indicates the incremental step.

5.10.2. Sorting data

In most of the application windows, you can sort records in some columns by clicking their titles with the left mouse button. The active column then will be marked with a small blue arrow, indicating the direction of sorting:

- the up arrow is for the ascending/A to Z order;
- the down arrow is for the descending/Z to A order.

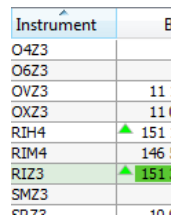

Instrument	B
O4Z3	
O6Z3	
OVZ3	11.1
OXZ3	11.0
RIH4	151.1
RIM4	146.8
RIZ3	151.1
SMZ3	
SNZ3	10.0

Fig. 5.16. Sorting by column

Every window has its own parameters to sort data by:



- the **All trades/ requests**, **Your trades/ requests** and **Your orders/ requests** windows - by time (the **Time** column);
- the **Order-book** window - by order price (the **Price** column);
- the **Options board** window - by strike (the**Strike** column);
- the **Positions/ requests** and **Money** windows - by account (the **Account** column) and any more parameter;
- the **Financial instruments** window - by any column. The sorting is made in its own specific way - see section 6.1.2.3.

5.10.3. Contextual search in tables

You can do contextual search in the **All trades/ requests**, **Your trades/ requests**, **Your orders/ requests**, **Financial instruments** and **Options board** tables.

You can activate the contextual search line by pressing the **Ctrl+F** key combination. After that, the line will appear between the window title line and the column titles, where you can enter any consequence of symbols to search for. To start search, press **Enter** - the cursor will be placed in the line where the target sequence of symbols is situated. The search is applicable to every field in the window.

To go to the next search object press the **F3** key of keyboard or use the arrow buttons:

-  - go to the previous search object containing the target sequence of symbols;
-  - go to the next search object containing the target sequence of symbols.

Button  allows to filter records in the window according to a selecting criteria, i.e. only the records with specified sequence of symbols will be shown. Please note that the filtering mode is on and active only when the search box is open. Once you close the search box, the filtering mode becomes inactive, and the window will display all available records.

Once you have found what you searched for, press **Done**. The mouse cursor will remain on the last found search object.

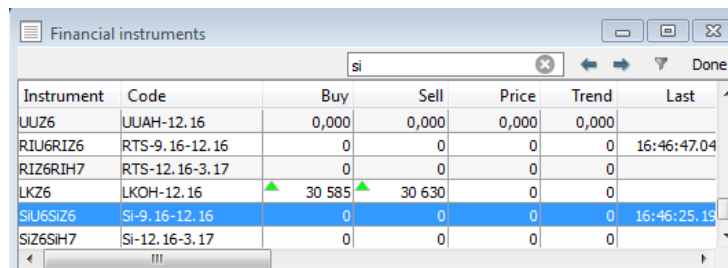

Instrument	Code	Buy	Sell	Price	Trend	Last
UUZ6	UUAH-12.16	0,000	0,000	0,000	0,000	
RIU6RIZ6	RTS-9.16-12.16	0	0	0	0	16:46:47.04
RIZ6RIH7	RTS-12.16-3.17	0	0	0	0	
LKZ6	LKOH-12.16	30 585	30 630	0	0	
SIU6SIZ6	SI-9.16-12.16	0	0	0	0	16:46:25.19
SIZ6SIH7	SI-12.16-3.17	0	0	0	0	

Fig. 5.17. Contextual search

5.10.4. Filtering

You can set filtering preferences via the following options:

- via the **Add filter Only '...'** context menu items. The menu item is available only for the columns to which filtering is applicable. The filter is set in accordance with the parameter value in the cell where cursor is placed. The list of possible filtering parameters can be found via the **Window settings/ Filters** menu item;
- via the **Filters** context menu item, for the column, to which multiparameter filtering option is applicable. In the list of filtering parameters, select the one you need with the left mouse button. You can select only one filtering parameter at one time; to select more than one parameter, you will have to open the list of filtering parameters as many times as it is necessary. Please note, that if you cannot find a needed parameter in the context menu, it can be useful to try to use the **Filters** section of the **Window settings** context menu item instead, as there are some parameters, for which usage of several filters at once is not provided;
- via the **Filters** section of the **Window settings** context menu item.

To apply the instrument filter you can use:

- the **Select instrument** context menu item, which is available only for the **Instrument** column. The **Select instrument** window opens on the screen (see section 5.11.1), where you can select a needed instrument. After selection is done, the filter will be applied according to the selected instrument;
- the **Add filter** context menu item, which is available in the **Instrument** column after selecting a cell containing the instrument code needed;
- the **Window settings** context menu item of the **Filters** section.

After the filter has been applied according to the selected column, this column title will be market in bold.

You can set all the available filters preferences via the **Window settings/ Filters** context menu item.

You can cancel filtering by using:

- the **Clear filter** context menu item (open from the column title). This option allows to clear the previously applied filter (please note, that absence of this menu item indicates that the filter has not been applied);
- the **Remove all filters** context menu item (open from the column title), which clears all filters by all parameters. Please note, that absence of this menu item indicates that the filter has not been applied);
- the **Filters** context menu item, for the columns, to which multiparameter filtering option is applicable . In the parameters list, check all possible parameters by clicking them with the left mouse button;
- the **Window settings/ Filters** context menu item. To clear filters, check the parameters you need to be displayed.

Once you close the window and then open it again, the window will be open in its default configuration, causing all your filter settings to be lost. To save your settings, you should save the current configuration as default via the **Current window/ Save by default** main menu item. This configuration becomes active even after restarting the application.

To automatically save the current configuration when you exit the terminal should install option **Save the current desktop settings before exit (Settings/ Terminal settings/ Main/ Common)**.

5.10.4.1. Filtering settings via the window settings menu item

You can set options for all possible filters for all parameters for the current window by using the **Window settings** context menu item of the **Filters** section.

There are several ways for settings filters preferences:

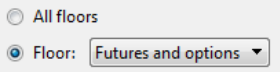
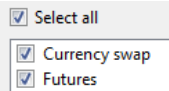
-  - select one of several values by clicking it with the left mouse button (usually, there is a selection between 'all values' and a particular one). You can select a particular value from the drop-down list;
-  - the **Select all** option allows to select/deselect all parameter values. The available parameter values are listed below, so you can also check/uncheck each value manually with the left mouse button. If there are some parameters left unselected, the **Select all** window will be marked in light-blue colour.

5.10.5. Context menu. General algorithm.

You can use context menu commands in every window of the trading terminal. The context menus may contain different commands depending on the window they belong to. Some commands which are common for all context menus are described below see Chapter 11.

There are some common principles of how the context menu commands work like.

- the commands:
 - **Add order;**
 - **Open all trades;**
 - **Open Order-book;**
 - **Add chart;**
 - **Add volatility curve;**
 - **Information;**

stay invisible in context menus until you have selected at least one element of the current table or window;
- the context menu item **Information** is always active;
- when you select an element, only the context menu items allowed for this instrument become active;
- when you select more than one element, the following context menu items stay inactive:
 - **Add order;**
 - **Open Order-book;**
 - **Add volatility curve;**

but the context menu items **Add chart** and **Open all trades** may become active in case they are allowed for all the selected instruments;

- the context menu items will display the instrument name if you select a single instrument. But the instrument names are never displayed if you select more than one instrument.
- if you select more than one instrument, the active context menu items will display information for all selected elements:
 - the window **Information** will contain information on all selected instruments of any type (indices, options, futures, etc.);
 - the window **Tech. analysis** will contain charts (candlesticks, volume) for the selected instruments; the chart for each instrument will be added into a separate window;
 - the selected instruments filter will be applied to the **All trades** window.

5.11. Auxiliary dialog boxes

The chapter overviews the following auxiliary windows:

- **Select instrument;**
- **Favorite instruments.**

5.11.1. Select instrument window

The **Select instrument** window is used every time you need to select an instrument for working with it, i. e. creating a graphical chart or opening an Order-Book window.

The window title line usually contains detailed information about the aim of the instrument selection.

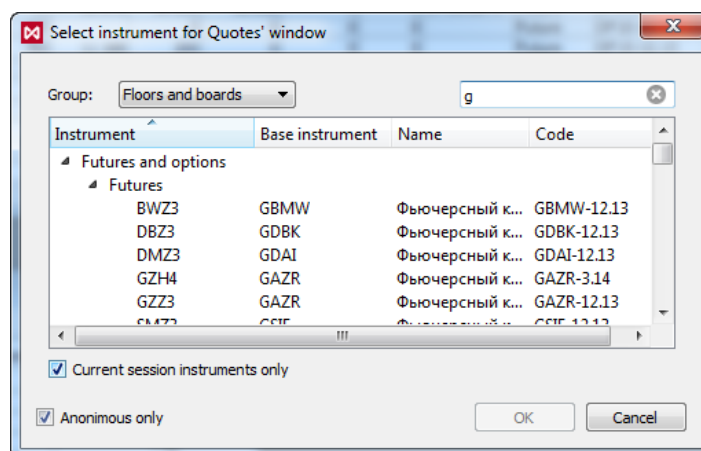

Fig. 5.18. Select instrument window

The window contains all instruments of all floors and all boards; you can group the instruments by selecting an appropriate value from the **Group** drop-down list:

- **Floors and boards** – group instruments by floors, then by boards;
- **Floors** - group instruments by floors, then from A to Z;
- **Boards** - group instruments by boards, then from A to Z;
- **Types** - the instruments are grouped by instrument type;
- **Underlying asset** - group instruments by floors, then by underlying assets;
- **Floors and types** - group instruments by floors, then by boards;

- **Boards and types** - group instruments by boards, then by instrument types;
- **Floors, types, boards** - group instruments by floors, then by types, then by boards;
- **total** – group instruments from A to Z.

The contextual search option is available in the instrument selection window. To specify a search pattern, enter the sequence of symbols in a field right from the **Group** field - search then will start automatically. While searching, the system looks up for the target consequence of symbols in every field of the record. The window will display all records containing the sequence of symbols; the best matched results will be displayed on top. After the searching complete, you can additionally apply any of the grouping options described above to the results. To cancel the search and return to the whole list of instruments, simply clear the search field.

The **Anonymous only** option allows to filter the main list of instrument. When it is active (by default), only anonymous instruments will be displayed in the main list of instruments.

The **Current session instruments only** option allows to filter the main list of instruments. When it is active (by default), only the instrument traded in the current trading session will be displayed in the main list of instruments.

To select an instrument, double-click it with the left mouse button or select it with cursor and press **OK**.

To cancel selection, press **Cancel**.

5.11.2. Favorite instruments

It may be convenient having the most usable instruments grouped in a separate list of 'favorite' instruments with fast access to it. Negotiated instruments can not be in the list of **Favorite instruments**.

There are several ways to create and manage the list of favorite instruments:

- via the **Favorite instruments** window - see section 5.11.2.1;
- via the **Favorite instruments** area in the in the side panel (see section 5.4.), by dragging-and-dropping there one of the following windows: **Financial instruments**, **Options board**, **All trades/ requests**, **Your trades/ requests** and **Your orders/ requests**;
- via the **Add to favorites** and **Remove** context menu items, when context menu is open at the line containing a favorite instrument.

You can access the favorite instruments list from:

- the **Settings/ Favorite instruments** menu item of the **Favorite instruments** window. The **Favorite instruments** windows contains all favorite instruments, no matter whether they are traded in the current session or not. The following operations are available there: open Order-Book window, create graphical chart, add order into the trading system;
- the **Favorite instruments** area of the side panel. This list contains only those instruments which are traded in the current trading session, with the price direction information marked in red and green in case of rise and fall, respectively.

Favorite instruments	
SIM7	
57 011	57 015
BR (BRM7)	
54,27	54,28
RTS (RIM7)	
107 900	107 910
MIX (MXM7)	
195 375	195 425
RTSI	
1 082,87	

Fig. 5.19. Side panel - Favorite instruments

The side panel allows to make the following actions with the favorite instruments:

- open Order-Book window;
- create graphical chart;
- add volatility curve;
- add order into the trading system;
- open the **All trades/ requests** window, containing trades with selected instruments only;
- open the **Information** window;
- add volatility curve;
- add an instrument into the list of favorite instruments;
- remove an instrument from the list of favorite instruments;
- open the **Favorite instruments** window.
- from the **Tables/ Order-book for instrument** main menu item. From there, you can open the **Favorite instruments** window or select an instrument from the list of the favorite instruments:

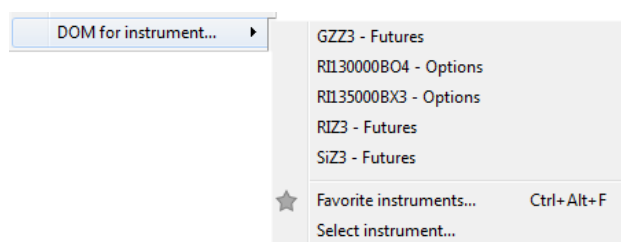



Fig. 5.20. Favorite instruments - menu

This menu item is used only for opening the Order-Book window for the selected instrument.

- from the **Tech. analysis/ Open chart** main menu item, which looks similar to the menu item described above. Using this menu item, you can create a graphical chart for the selected instrument;

- from the main instrument panel, using the following drop-down lists:  (opens Order-Book window) and  (creates graphical chart).

5.11.2.1. Favorite instruments window

The **Favorite instruments** window provides quick access to the most used ('favorite') instruments. These favorite instruments are available from the special window described above, as well as from the side panel - see section 5.4.

You can open the favorite instruments window by the following methods:

- from the **Settings/ Favorite instruments** main menu item; generally, it is used for setting up the favorite instruments list preferences;
- from the **Tech. analysis/ Open chart/ Favorite instruments** main menu item, when creating a new graphical chart;
- from the **Tables/ Order-book for instrument/ Favorite instruments** main menu item, when opening the Order-Book window;

- by pressing the **Ctrl+Alt+F** key combination;

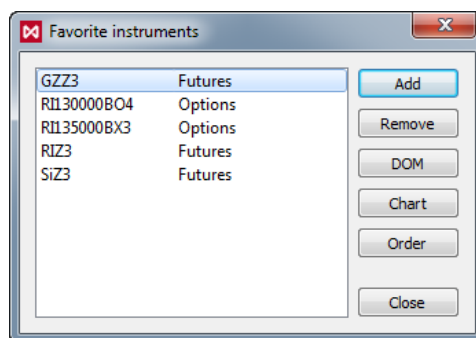

Fig. 5.21. Favorite instruments window

The instruments which are not traded in the current trading session are not removed from the list but get marked in grey instead.

When you create a new list of favorite instruments, sometimes it may be convenient to select instruments from the board **Nearby futures contracts** (you can select the board in the appropriate list). After such an instrument has been selected, the name of a futures contract with the nearby expiration date will be displayed in the list; once the futures contract expires and be removed from the list, the next futures contract for the same underlying asset will be added, replacing the expired one, and so on. The nearest futures contract ID is displayed within brackets, next to the underlying instrument ID - for example: **RTS (RIM7)** or **GAZR (GZM7)**.

When you create a new graphical chart or open the Order-Book window, there is also the full list of favorite instrument displayed in menu along with the **Favorite instruments** menu item. You can select a favorite instrument in the list simply by clicking it with the left mouse button.

The following buttons are used for setting the **Favorite instruments** list:

- **Add** – opens the **Select instruments** window (see section 5.11.1) and adds a selected instrument into the list of favorite instruments;
- **Remove** – removed an instrument from the list of favorite instruments (please note, that there is no removal confirmation appears!). You can also remove an instrument from the list via the **Remove** context menu item.

The **Favorite instruments** list allows to select more than one record using the **Shift** and **Ctrl** key combination. Some actions may be applied to groups of instruments.

The following actions can be applied to the instruments in the list using the corresponding keys(fig. 5.21):

- **Order-book** – opens the Order-Book window (see section 6.2.2) according to the selected instrument;
- **Chart** – adds a graphical chart for the selected instrument in the **Tech. analysis** window (see section 9.2). If more than one instrument selected in the **Favorite instruments** window, the chart for each instrument will be added into a separate window;
- **Order** – opens a window for adding orders into the trading systems according to the selected instrument (see section 6.2.3.1).

Press **Close** to close the **Favorite instruments** window.

Most of the action listed above can be done via the corresponding context menu items opened from the **Favorite instruments** list. The context menu contains the following items:

- **Add order at <instrument code>** – opens the order adding window for the selected instrument (see section 6.2.3.1). This menu item is available after selecting a single instrument only;

- **Request to NCC for <instrument code>** – opens the request to NCC window for the selected instrument (see section 6.2.5);
- **Open all trades** - opens the window **All trades/requests** for the selected instruments (one or more than one);
- **Open Order-book** - opens the order-book window for the selected instrument (the one under your cursor). This menu item is available after selecting a single instrument only;
- **Add chart** - adds a graphical chart for the selected instrument in a separate **Tech. analysis** window. If more than one instrument selected in the **Favorite instruments** window, the chart for each instrument will be added into a separate window;
- **Add volatility curve** - adds volatility curve into a separate window. This menu item is available for option contracts only after selecting a single instrument;
- **Information** - opens the **Information** window for the selected instruments (one or more than one). The window will contain information on all the selected instruments including indices, options and futures; the window will contain the same parameters for all the instrument in accordance with the parameters set for the first selected one.
- **Remove** - removes a selected instrument from the list of the favorite instruments.

5.12. Data export

You can export data using the following methods:

- **Interactive data export** - see section 5.12.1;
- **dynamical data export** - see section 5.12.2.

There are two export formats are available:

- **text** - CSV format file. When you export into this format, the fields' names are generated from internal identifiers (you can view them in the **Identifier** column of the **Columns** tab in the window setup dialog box);
- **dBASE** - DBF and DBF7 file formats. As the dBASE Level 7 file format supports up to 31-symbol name length (contrary to the standard dBASE IV, which supports only 10-symbol name length), it allows to keep the initial names of the fields. Before exporting, each field name is checked to be the unique; otherwise, there are additional postfix (a digit or the underscore symbol) added in the name of the file.

You can specify some global settings for the exporting data via the **Settings/ Terminal settings/** section **Main/** tab **Common/** group **Data export** main menu item (for more details see section 10.1). The following settings are available:

- **Upload all columns while exporting** - allows to download all table's columns irrespectively to the user settings;
- **Code to DBF format while exporting** - allows to select the DBF format data charset.

5.12.1. Interactive data export

You can export data using the following methods:

- using the **Export** context menu item from any functional window;
- using the **Current window/ Export** main menu item for the current window.

You can select the export file format and path in a standard dialog box:

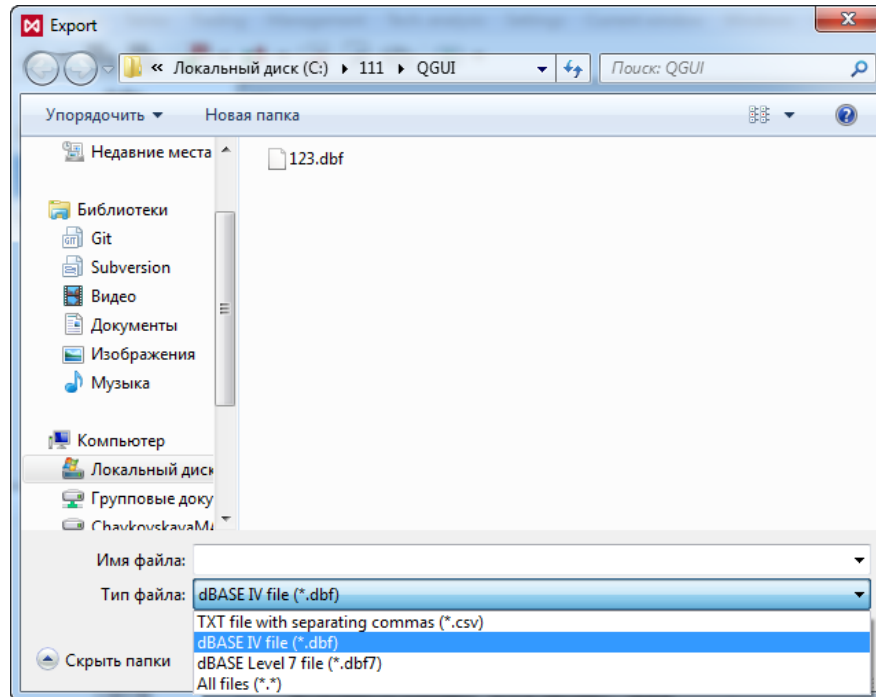

Fig. 5.22. Select the export data's format

To cancel exporting, press the **Cancel** button in the progress-bar window:

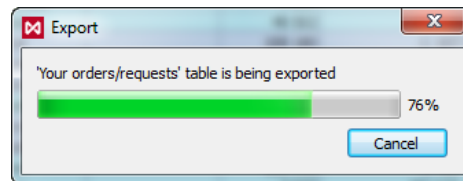

Fig. 5.23. Data export window

5.12.2. Dynamical data export

The dynamical data export is performed repeatedly, at a specified time interval, into the same output file. Should there be any changes, the output file data will be fully rewritten with new data. Otherwise, the output file will remain unchanged.

To perform the dynamical data export use:

- the context menu item **Dynamical export**, for any functional window (except the chart area in Option Calculator);
- the main menu item **Current window/ Dynamical export**, for the current window.

When the dynamical export option for a functional window is on, the context menu item **Dynamical export** will be highlighted in light blue.

When the dynamical export option for a functional window is on, the context menu item **Dynamical export** will be marked with a tick.

When the dynamical export option for a functional window is off, all marks and highlights will be removed from the appropriate context menu item.

When you have activated the context menu item **Dynamical export**, a window appears on the screen where you can specify the output data file path and name (the field **File**) and a time interval value to perform the dynamical export:

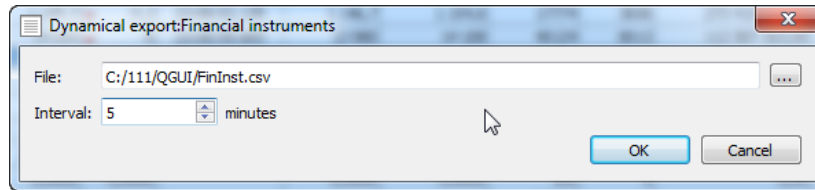

Fig. 5.24. Dynamical export settings

By pressing **OK**, the initial data export runs. After that, the export will run automatically in accordance with the time interval value you had specified in the window **Dynamical export** until you stop it manually (see section 5.12.2.1).

If the output file specified has been already used by another dynamical export service (for example, in another functional window), the warning message appears on the screen: '*Attention! The specified file has been already used for exporting in the following windows: <the window name>*'. Please note, that in case of choosing an existing file name, the previous export data in the file will be fully overwritten with the new data.

If you have specified an invalid extension for the data output file, the warning message appears on the screen: '*Attention! Invalid file extension!*'. In this case, the button **OK** becomes inactive.

There is a dedicated window displaying the dynamical data export progress details:

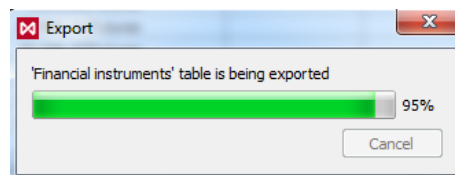

Fig. 5.25. Dynamical export progress bar

The dedicated window for dynamical export progress bar appears in the lower right corner of the screen every time you run the data export service, no matter if the **Dynamical export** window is active or not. The button **Cancel** stops the dynamical export procedure. In order to prevent occasional clicks, the button **Cancel** appears inactive on the panel and becomes active later in 1 second.

Also, a if there is any dynamical export procedure running, the small icon  appears on the right side of the application status bar:



Fig. 5.26. Dynamical export icon in the application status bar

Pressing the icon with the left mouse button evokes a list of windows with the dynamical export procedures currently running:

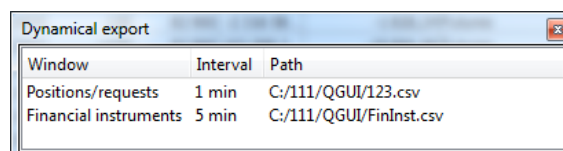

Fig. 5.27. Window 'Dynamical export'

In the window **Dynamical export** you can do the following actions via the appropriate context menu items:

- **Switch to window** - allows you to switch to a selected window. This action is set as the default one, i.e. it will be performed by double clicking the left mouse button on a record in the window;

- **Cancel dynamical export** - allows you to cancel dynamical export process for a selected window. To select a window, move the mouse cursor over its name in the list.

After you exit the trading terminal application, all dynamical export settings will be saved automatically. Therefore, the dynamical export services will automatically resume for the selected windows with the next start of the trading terminal application.

5.12.2.1. Cancelling dynamical export

You can do one of the following actions to cancel the dynamical export:

- Click the appropriate context menu item to disable dynamical data export for the window, in which the context menu had been opened;
- press the button **Cancel** in the window **Export** (see fig. 5.25) in order to stop the dynamical export process for the data already exporting;
- use the context menu item **Cancel dynamical export** in the window **Dynamical export** (see fig. 5.27) in order to cancel dynamical data export for the selected window.

Chapter 6. Using the application functions

This chapter overviews the main application functions:

- viewing information about trading,
- orders managing,
- trades managing,
- OTC trades managing,
- multi-leg instrument operations managing,

For every table, you can select the columns you want to be displayed. Also, you can vary the order of columns in the table.

For the **All trades/ requests**, **Your trades/ requests**, **Your orders/ requests**, **Financial instruments** and **Options board** tables there is an option of contextual search available (**Ctrl+F**). To select a record in the list, you can move cursor up or down either using the arrow buttons to the right of the search field, or using the follow key combinations:

- down - **F3**;
- up - **Shift+F3**.

For every table, you can copy its content to clipboard or export into file.

Some large tables, such as **All trades/ requests**, **Your trades/ requests** and **Your orders/ requests**, use cached data in order to reduce loading time, so every time you connect to the trading system, these tables will load starting from the last viewed point.

Some small tables, such as **Financial instruments**, **Sessions**, **Order-book** and **Positions/ requests**, are fully reloaded every time you establish a new connection to the trading system.

Futures and options are displayed in the same tables. If you want to view them separately, you can apply the trading board filter.

6.1. Viewing information

The **Tables** main menu item contains the main functions for viewing information about trading.

This section overviews the following functional windows:

- Financial instruments;
- Information;
- Sessions;
- Money;
- Positions/ requests;
- Positions by settlement accounts.

For information about orders and trades windows please see the appropriate sections of this manual.

6.1.1. Information – parameters of the current record

The **Information** mode is used for viewing all parameters of the current record (the record where cursor is placed) in the functional window.



You can switch to the information mode via the following methods:

- via the **View/ Information** main menu item;
- by pressing the **Ctrl+I** key combination;
- via the **Information** context menu item.

You can open the **Information** window from the following windows, containing information about trades and instruments, such as: **Financial instruments**, **Options board**, **Your orders/ requests**, **Your trades/ requests**, **All trades/ requests**, **Order-book**, as well as the **Favorite instruments** area of the side panel. Absence of the **Information** menu item in the context and main menus indicates that the **Information** window cannot be opened for the current active window.

After opening the **Information** window, this window becomes active. You can open more than one information windows at once, each for its own instrument.

If some instruments are traded in the same board, you can view them in the same window; to set this view mode, use the **Add instrument** context menu item or drag and drop instruments from other windows holding the **Ctrl** key pressed. To add instruments from the **Options board** window you should drag and drop the selected instrument to the **Information** window holding the **Shift** key pressed; two instruments (both PUT and CALL options) will be added into the window. For example, you cannot add an option by dragging it (with the **Ctrl** key pressed) into the **Information** window containing information of futures. In addition, the special marks will help to know whether adding of an instrument is

possible - , or not - .

You can change an instrument right in the **Information** window by dragging it from another feature windows or via the **Change instrument(s)** context menu item. Note, that no new window will appear on the screen in this case, but information in the existing window will be refreshed. If there are several instruments with different exercising dates for one underlying asset (for futures and calendar spreads), then they will be additionally displayed in the context menu.

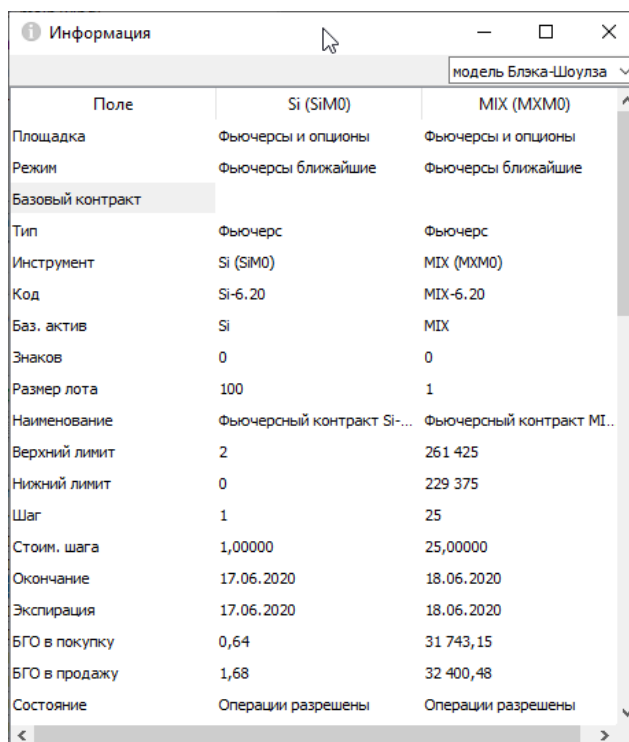

Поле	Si (SiM0)	MIX (MXM0)
Площадка	Фьючерсы и опционы	Фьючерсы и опционы
Режим	Фьючерсы ближайшие	Фьючерсы ближайшие
Базовый контракт		
Тип	Фьючерс	Фьючерс
Инструмент	Si (SiM0)	MIX (MXM0)
Код	Si-6.20	MIX-6.20
Баз. актив	Si	MIX
Знаков	0	0
Размер лота	100	1
Наименование	Фьючерсный контракт Si-...	Фьючерсный контракт MI...
Верхний лимит	2	261 425
Нижний лимит	0	229 375
Шаг	1	25
Стоим. шага	1,00000	25,00000
Окончание	17.06.2020	18.06.2020
Экспирация	17.06.2020	18.06.2020
БГО в покупку	0,64	31 743,15
БГО в продажу	1,68	32 400,48
Состояние	Операции разрешены	Операции разрешены

Fig. 6.1. Information window

The **Information** window contains information of the both **Put** and **Call** options in two columns with the same instrument code, but with different values in the **Type of option** field.

The **Field** column contains parameter name and the instrument code column contains the parameter value for the instrument. If the parameter list is too long, then scrollbar will appear in the right side of the window.

You can select parameters to be displayed in the **Information** window. You can do it in two ways:

- via the **Settings/ Terminal settings/ Information** main menu item. This setting is the default for every **Information** window.
- via the **Window settings** context menu item. This settings are used for a particular instrument trading board, when the board is chosen in accordance with the instrument data in the **Information** window. After the settings are applied, every information window for every instrument of the same board will obtain exactly the same parameters as the initial window has, overriding parameters set via the main menu item. For all other boards, the **Information** window will be opened with the settings set via the **Settings/ Terminal settings/ Information** menu item.

You can configure the widget to select the option pricing model that will be displayed in the upper right corner of the window. You can do it via the **Window settings** context menu item (see section 11.1), setting the **Show in toolbar** option on the **Main** tab. By default, the widget is not displayed in the window. The choice of pricing model is actual for options and allows to choose the Black-Scholes or Bachelier (support for negative prices) model for calculations. If the widget is not displayed, then you can change the option pricing model via the **Window settings** context menu item, selecting the desired model from the drop-down list in **Option pricing model** field on the **Main** tab and then clicking on the **OK** or **Apply** button.

You can configure the widget to select the option pricing model that will be displayed in the upper right corner of the window.

Data in the **Information** window refreshes automatically, following the trading data updating.

Once opened, the **Information** window will be saved in the workspace configuration and reopened automatically at the next launch.

You can copy data from the **Information** window and paste it into another documents. To copy data, select it by using mouse, **Shift + Ctrl** key combination or by using the appropriate command in the context menu (to select all data in the window) and press the **Ctrl+C** key combination or click the **Copy** context menu item.

You can close the **Information** window in the following ways:

- by pressing **Esc**;
- by pressing the **Alt+F4** key combination, if the window is unpinned;
- by clicking  in the window header.

The **Information** window context menu contains the following menu items:

- **Open Order-book** - opens the Order-book window for the selected instrument;
- **Open chart** - opens the **Tech. Analysis** window containing graphical data for the selected instrument;
- **Copy (Ctrl+C)** - copies selected data from the **Information** window;
- **Select all (Ctrl+A)** - allows to select all data in the **Information** window;
- **Delete instrument** - deletes the selected instrument from the list in the **Information** window;
- **Add instrument** - adds a new instrument from the **Select instrument** window into the **Information** window. All instruments in the list are of the same board as the ones in the **Information** window.
- **Change instrument(s)** – opens the **Select instrument** window, containing instruments of all boards. All open instruments will be deleted from the **Information** window;
- **Fit width for all columns** - allows to automatically fit width for all columns in according with their content;
- **Fit width** 'column's name'– allows to automatically set the column width in accordance with its content. This action can also be performed by placing mouse cursor on the line between two columns (the cursor should get arrow-shaped) and double-click the left mouse button;

- **Window settings** - opens the window settings dialog box. Allows to specify parameters for all instruments of the current board (futures, options, securities, etc.). The board is determined according to the instruments in the **Information** window.

6.1.2. Financial instruments

The **Financial instruments** window contains information of all instruments and indexes traded in the current trading session. The data update at every reconnection.

You can open the window using the **Tables/ Financial instruments** main menu item.

You can sort data in the table by any parameter you like – i. e. by every column (see section 5.10.2).

Instrument	Buy	To buy	Sell	To sell	Price	Trend	Q-ty	Last	Type	Code	Base instr...	Signs	Lot si
DMZ3		0		0	0,000	0,000	0		Future	GDAI-12.13	GDAI	3	
UJH4		0		0	0,000	0,000	0		Future	UJAH-3.14	UJAH	3	1 0
SMV3		0		0	0,00	0,00	0		Future	GSIE-10.13	GSIE	2	
LKZ3	▲ 21 472	12	▲ 21 486	12	21 464	0	1	12:42:00.9...	Future	LKOH-12.13	LKOH	0	
TNZ3		0		0	80 210	0	15	15:31:11.6...	Future	TRNF-12.13	TRNF	0	
SIM4	▼ 33 089	3	▲ 33 546	1 000	33 628	▲ 51	1	23:20:24.6...	Future	SI-6.14	SI	0	1 0
MXU5		0		0	0	0	0		Future	MIX-9.15	MIX	0	
MXZ3		0		0	0	0	0		Future	MIX-12.13	MIX	0	
RIZ3	▼ 149 150	664	▲ 149 170	8	▲ 149 160	0	1	12:43:13.6...	Future	RTS-12.13	RTS	0	
O4Z3		0		0	0	0	0		Future	OFZ4-12.13	OFZ4	0	
DIMV3		0		0	0,000	0,000	0		Future	GDAI-10.13	GDAI	3	
GZH4	15 500	4		0	15 500	0	1	09:58:11.9...	Future	GAZR-3.14	GAZR	0	1
OVZ3		0		0	11 186	0	5	10:56:24.4...	Future	OF15-12.13	OF15	0	
RIM4	▲ 144 230	1	144 860	1	145 220	▲ 1 440	1	10:14:50.1...	Future	RTS-6.14	RTS	0	

Fig. 6.2. Window Financial instruments

Tab. 6.1. Parameters in window Financial instruments

Parameter	Details
Instrument	Instrument short code. When an instrument belongs to the board Nearby futures contracts , the nearest futures contract ID is displayed within brackets, next to the instrument ID. For example: RTS (RIM7) . The board Nearby futures contracts contains futures contracts with the nearby expiration dates. Once a futures contract expires and be removed from the list, the next futures contract for the same underlying asset will be added, replacing the expired one, and so on. You can turn displaying of the nearest futures contracts in the window Financial instruments on and off; to do this, you should specify the board settings in the list of trading boards, when you set up the filtering parameters (see section 6.1.2.1).
Code	Instrument code.
Board	Instrument board.
Buy	Best buy order price.
For buy	Quantity in the best buy order.
Sell	Best sell order price.
For sell	Quantity in the best sell order.
Price	Price of closing trade.
Sings	Digits after decimal point in price.
Lot size	Quantity of underlying asset units in instrument.
Trend	Price fluctuation trend (difference between prices of two last trades).

Parameter	Details
Last	Date and time of last trade.
Min price	Minimum price.
Max price	Maximum price.
Op. pos.	Current amount of open positions.
Volume	Total number of lots in trades.
Turnover	Total trades volume.
Upper limit	Price upper limit.
Lower limit	Price lower limit.
Step	Minimum price step.
Cost of step	Cost of step price.
Floor	Floor short name.
Underlying contract	Option underlying contract.
Q-ty	Amount in the last trade.
Type	Type of instrument.
Name	Instrument name.
Ending	Instrument expiration date.
Avg.	Average price.
Expiration	Instrument expiration date.
UC (Buy)	Underlying collateral for Buy transactions.
UC (Sell)	Underlying collateral for Sell transactions.
Quote	Current quotation.
Market quot.	Market quotation.
State	Trading status for instrument.
Direction	Instrument price direction - direction of the order which initiated the trade.
Und. asset	Underlying asset code.
Type of option	Type of option: put or call.
Type of calculations	Type of calculation for option.
Session	Session name.
Trades	Amount of trades.
Prev. price	Setting price of previous session.
Changed	Date and time of record modification.
Amount to sell	Amount of sell orders.
Amount for selling	Amount in sell orders (in contracts).
Amount to buy	Amount of buy orders.
Amount for buying	Amount in buy orders (in contracts).
Opening price	Opening price.
Closing price	Closing price.
Strike step	Options strike step.
Volatility	Implied volatility.
Theoretical price	Option theoretical price.
Currency rate	Rouble to US dollar exchange rate.

Parameter	Details
Delta	Option Delta.
Gamma	Option Gamma.
Vega	Option Vega.
Teta	Option Theta.
Prise of prev. clearing sess.	Prise of previous clearing session.
Collateral for covered positions	Underlying collateral per one covered subscriber's position. Collateral for synthetic position.
Collateral for naked pos.	Underlying collateral per one naked subscriber's position (RUB). Underlying collateral.
Collateral for buy	Underlying collateral for future-style option buying. Collateral for buying.
ACI	Accrued coupon interest.
Placing	Placing - for bonds.
Maturity date	Maturity date.
Coupon rate	Coupon rate.
Coupon period	Coupon period.
Coupon maturity date	Coupon maturity date.
Issued volume	Issued volume.
Price2	Multi-leg instrument near leg price.
Yield basis	Basic price to calculate yield.
Yield period	Date to calculate yield.
Change against prev.	Change against previous value (in points).
% change against prev.	Change against previous value (in percent).
UA name	Underlying assets name.
Yield	Yield on futures on interest rates.
Market risk	Market risk rate.
Market risk 1	Market risk rate value (Concentration Limit 1).
Market risk 2	Market risk rate value (Concentration Limit 2).
Concentration Limit 1	Amount of underlying asset, in units (Concentration Limit 1).
Concentration Limit 2	Amount of underlying asset, in units (Concentration Limit 2).
Premium turnover	Total turnover at option premium.
Exchange fee	Exchange fee rate.
Clearing fee	Clearing fee rate.

The fixed column is highlighted in yellow colour. This indicates, that the fixed column is always the first visible column in table, and it never hides even if you scroll the table. You can set any column in the table as 'fixed' by adding its name into the **Fix column** field in the **Window settings** context menu item of the **Columns** section. Fixed columns allow you to sort data in them simply by clicking the left mouse button on the column header.

Some fields in the **Financial instruments** window, such as 'best buy price', 'best sell price' and 'last trade direction' are highlighted in colours. You can specify this settings via the **Window settings/ View** – see section 11.2.

You can switch off the colour indication options via the **Window settings: Highlight buy-sell** and **Highlight last trade direction** context menu items of the **View** section.

Apart from the user specified colour indication, there is also colour indication for sell and buy prices sells, when little green and red arrows indicate price direction. This option cannot be switched off.

The **Financial instruments** window allows to apply the instrument filter. You can specify its settings via the **Window settings/ Instruments** context menu item – see section 6.1.2.2

If the instruments in the **Instruments** filter window have been selected manually, the ones in the **Financial instruments** window will not be updated automatically (for example, at trading session change). If the instruments have been filtered by groups, then new instruments will be added into the **Financial instruments** window automatically at trading session change.

The **Financial instruments** window provides possibility of contextual search (see section 5.10.3). You can activate the search window by pressing the **Ctrl+F** key combination.

You can configure the widget to select the option pricing model that will be displayed in the upper right corner of the window. You can do it via the **Window settings** context menu item (see section 11.1), setting the **Show in toolbar** option on the **Main** tab. By default, the widget is not displayed in the window. The choice of pricing model is actual for options and allows to choose the Black-Scholes or Bachelier (support for negative prices) model for calculations. If the widget is not displayed, then you can change the option pricing model via the **Window settings** context menu item, selecting the desired model from the drop-down list in **Option pricing model** field on the **Main** tab and then clicking on the **OK** or **Apply** button.

To open the Order-book window for the certain instrument, double-click the instrument name in the **Financial instruments** window (see section 6.2.2). Also, you can open the Order-book window by using the **Open Order-book** context menu item.

During the intermediate trading sessions (morning and evening), the instrument list contains only the instruments which are traded on the current intermediate session, when each instrument is selected for intermediate trading by the trading administrator. All other instruments become visible at the beginning of the main trading session.

6.1.2.1. Filters in the Financial instruments window

You can specify filter settings for the **Financial instruments** window in the following ways:

- by using the **Window settings** context menu item of the **Filters** section;
- via the **Only 'parameter'** context menu item. Filter will be applied according to the parameter in the cell under mouse cursor. If the parameter under mouse cursor is not applicable for filtering, then the **Only** menu item will be absent in the context menu. The list of applicable parameters can be found via the **Window settings/ Filters** context menu item.

After filter has been applied according to a parameter, its column header in the **Financial instruments** window will be marked in bold (except column **Instrument**). The parameter name in the **Window settings/ Filters** list will be also highlighted in bold - see fig. 8.5.

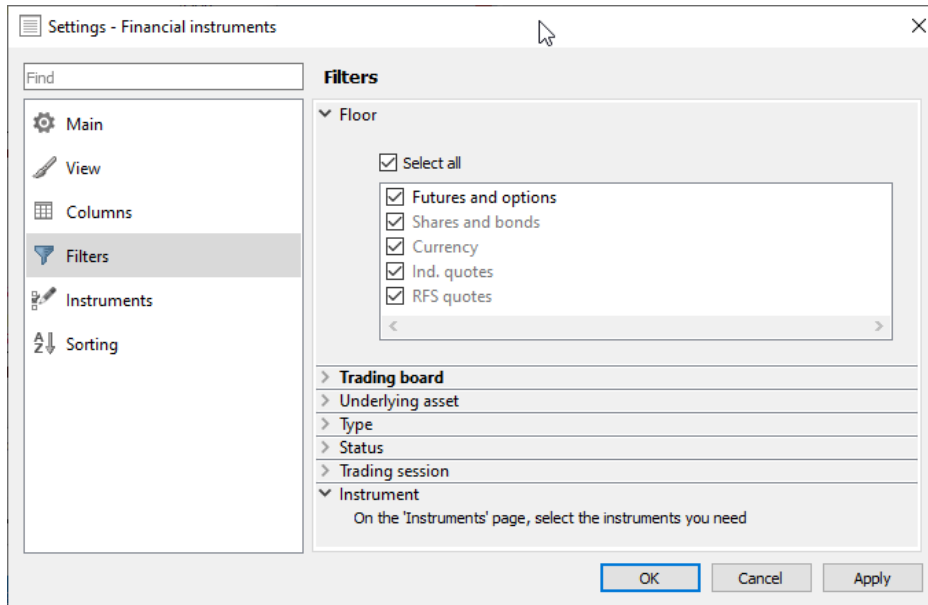

Fig. 6.3. Filter settings in the Financial instruments window

When a filter has been applied, the **Financial instruments** window will contain only the instruments allowed under the filter preferences. You can manually select the needed instruments by checking/unchecking checkboxes left of the instrument names with the left mouse button.

By default, the **Financial instruments** window contains all possible instruments.

Attention! Please note, that filters applied in the **Filters** and **Instruments** sections (see section 6.1.2.2) are used together. I.e., the window contains only the instruments which meet both filters' rules.

Tab. 6.2. Filter parameters in the Financial instruments window

Parameter	Details
Floor	Filter by trading floor. If the Select all option is active, then the window will contain all instruments for all trading floors. If the Select all option is inactive, the window will be empty. To select the floors you need, you should select them manually by checking the appropriate checkboxes. The list of available floors depends on the settings on the Transport tab (Settings / Terminal settings) - some records in the list may remain inactive (they highlighted gray color).
Trading board	Filter by trading board. If the Select all option is active, then the window will contain all instruments for all boards. If the Select all option is inactive, the window will be empty. To select the trading board you need, you should select them manually by checking the appropriate checkboxes.
Underlying asset	Filter by underlying asset. If the Select all option is active, then the window will contain all trades for all underlying assets. If the Select all option is inactive, the window will be empty. To select the underlying assets you need, you should select them manually by checking the appropriate checkboxes.
Type	Filter by instrument type.
Status	Filter by instrument status: <ul style="list-style-type: none"> • Operations allowed – all operations are allowed for the instrument; • Paused – trading session is paused; orders for the instrument can be removed; • Settlement only – only trade settlements are allowed for the instrument;

Parameter	Details
	<ul style="list-style-type: none"> • Operations prohibited – all operations are prohibited for the instrument.
Trading session	Filter by trading session: <ul style="list-style-type: none"> • Select all - display all available instruments; • Main trading session - display only the instruments traded in the Main trading session; • Evening trading session - display only the instruments traded in the Evening trading session; • Not traded - display only the instrument which are not currently traded.
Instrument	Filter by instrument. The filter settings can be specified in the Window settings/ Instruments section - see section 6.1.2.2.

You can deactivate the applied filter by the following ways:

- via the **Clear filter '...'** context menu item - to remove the filter for one parameter. Please note, that this menu item is available only in the context menu of the column, by which the filter has been applied (the column header will be marked in bold);
- via the **Remove all filters** context menu item - to remove all filters for all parameters. This menu item becomes available in the context menu when at least one filter has been applied to the list. Please note, that this menu item is available only in the context menu of the column, by which the filter has been applied (the column header will be marked in bold);
- via the **Window settings** context menu item of the **Filters** section. To remove filters simply activate the **Select all** mode.

Once you close the **Financial instruments** window and then open it again, the window will be open in its default configuration, causing all your filter settings to be lost. To save your settings, you should save the current configuration as default via the **Current window/ Save by default** main menu item. This configuration becomes active even after restarting the application.

Once you close the window and then open it again, the window will be open in its default configuration, causing all your filter settings to be lost. To save your settings, you should save the current configuration as default via the **Current window/ Save by default** main menu item. This configuration becomes active even after restarting the application.

To automatically save the current configuration when you exit the terminal should install option **Save the current desktop settings befor exit (Settings/ Terminal settings/ Main/ Common)**.

6.1.2.2. Filter for instruments in the Financial instruments window

The filter settings for the **Financial instruments** window can be applied in accordance with underlying asset of each instrument. You can do it via the **Window settings/ Instruments** context menu item:

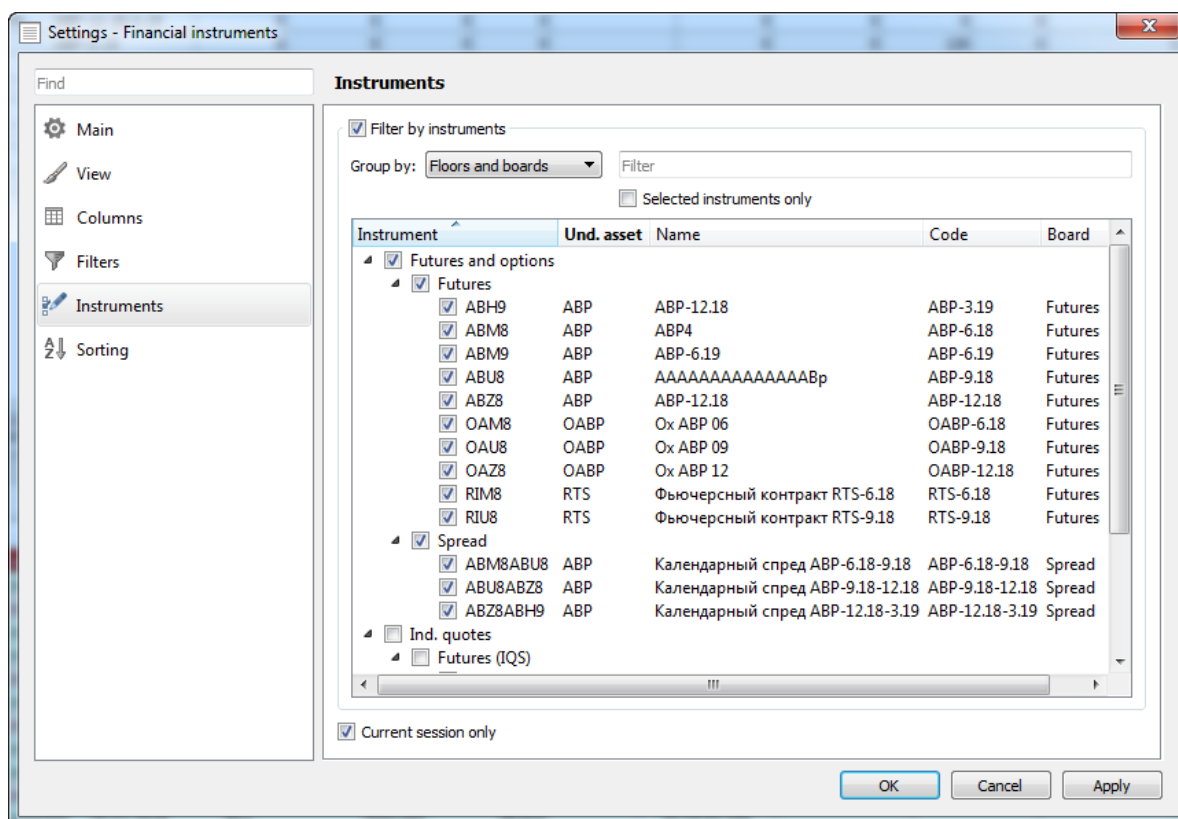

Fig. 6.4. Filter for instruments in the Financial instruments window

To activate the filter you should check the **Filter by instruments** checkbox. After that, you will be allowed to select instruments and their underlying assets in the list below.

You can group instruments in the list in the following ways:

- **Floors and boards** - by floors, then by boards;
- **Floors** - by floors only (boards are omitted);
- **Boards** - by boards only (floors are omitted);
- **Types** - by instrument types (indexes, options, etc.);
- **Underlying asset** - by underlying assets (floors and boards are omitted);
- **Floors and types** - by floors, then by instrument types;
- **Boards and types** - by boards, then by instrument types;
- **Floors, types, boards** - by floors, then by instrument types, then by boards;
- **<total>** - in alphabetical order (according to instrument codes).

You can search for an instrument in the list by typing its name into the contextual search field; the case-insensitive search starts immediately after entering the first symbol. The search results will display all records containing the entered symbols. To clear search results simply delete symbols from the search field.

If the **Selected instrument only** option is active, the filter list will contain only the active instruments names.

You can change the filter settings by checking/unchecking checkboxes left of each instrument name (please note, that the **Financial instruments** window contains only active instruments!). After selection is done, press **Apply** or **OK**.

To cancel filtering, simply set all instruments in the filter list as active.

The **Current session only** option allows to manage the instruments list in the filter window. If the option is active, the list will contain only the instruments traded in the current trading session. Otherwise, some expired instruments from the previous trading sessions may also be added into the list.

When a new trading instrument is added into the trading system, its visibility in the **Financial instruments** window will depend on the filter type applied for this window. If an applied filter includes a group of instruments, then the new instrument may (or may not, if it does not belong to the group) automatically become visible and active in the **Financial instruments** window. If the filter includes only some particular instruments, the new instrument will not be included in the list automatically, so that it will not appear in the **Financial instruments** window until you manually change the filtering preferences.

When the filtering mode by instrument is on, it is possible to remove unnecessary instruments from the filter list without opening the window settings by doing the following steps:

1. In the window **Financial instruments** with the filtering mode by instrument on, select the instruments you want to remove;
2. Select the context menu command **Remove selected instruments from filter list**.

Please note that the context menu command **Remove selected instruments from filter list** is available only when the filtering mode by instrument is on!

When the filtering mode by instrument is on, it is also possible to add instruments into the filter list by drag-and-dropping them from another functional windows, for example **Favorite instruments** or **Your orders/ requests**, into the window **Financial instruments**. After that, the instrument will be added into the filter list.

Once you close the **Financial instruments** window and then open it again, the window will be open in its default configuration, causing all your filter settings to be lost. To save your settings, you should save the current configuration as default via the **Current window/ Save by default** main menu item. This configuration becomes active even after restarting the application.

6.1.2.3. Sorting in the Financial instruments window

You can sort data in the **Financial instruments** window by clicking the left mouse button on every column's header. Each click changes the sorting mode repeatedly, i.e.:

- sorting in ascending order;
- cancel sorting;
- sorting in descending order;
- cancel sorting;
- sorting in ascending order;
- etc.

As the strings constantly shuffle following the changes in their values, this way of sorting allows you to stop sorting at any moment and fix the strings in the order they are for convenient viewing.

You can change the records order manually by selecting the **Manual sorting** context menu item. In this mode, you can select any string in the window by clicking it with the mouse left button (the string will be highlighted in blue colour), then drag and drop it to the position you need.

Please note, that once the manual sorting mode is on, you cannot sort data in the window by the column headers. To sort data by a column's header, first turn off the manual sorting mode in the context menu.

Also, you can specify sorting in the **Financial instruments** window via the **Window settings/ Sorting** context menu item.

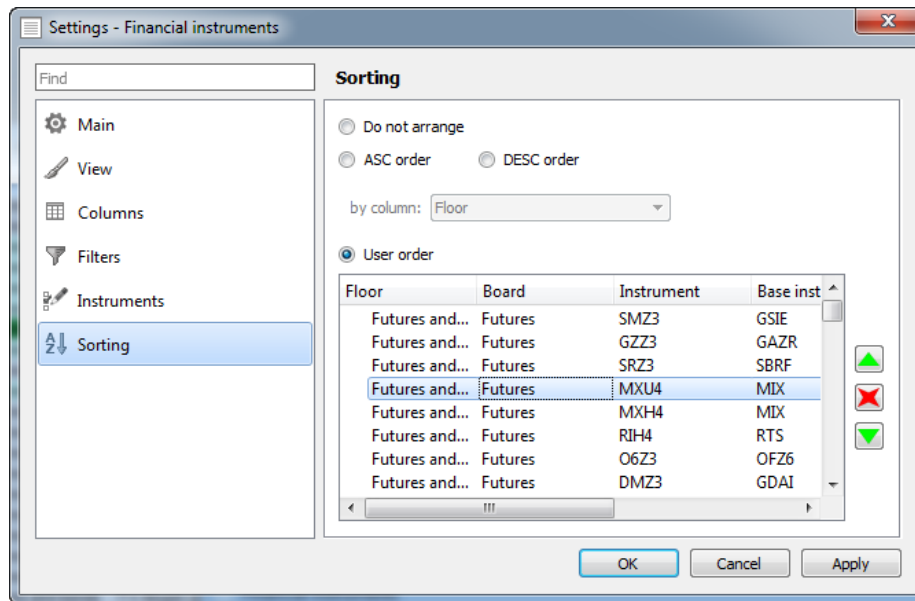





Fig. 6.5. Sorting in the Financial instruments window

You can turn on and off sorting by the table's every column. To do this, select one of the following ways of sorting:

- **Do not arrange** - sorting is off;
- **DESC order** - values in a selected column are sorted in descending order (or in backward alphabetical order);
- **ASC order** - values in a selected column are sorted in ascending order (or in alphabetical order).

The column name can be selected in the **by column** drop-down list.

If the filtering by instrument (**Window settings/ Instruments** - see section 6.1.2.2) is active, you can enable a user defined sorting order. To do this, use the **User order** option for selecting the strings you need. To move strings from one position to another, or hide it in the table (fig. 6.5), you should place cursor onto a string and press one of the following buttons:

-  - move one position up;
-  - move one position down;
-  - hide string in the table.

You can select more than one string at once using the **Shift** or **Ctrl** keyboard keys.

If the filtering by instruments is inactive, then you cannot arrange instruments in user defined order via the **Window settings/ Sorting** menu. Instead, you can do it in the **Financial instruments** window via the **Manual sorting** context menu item.

The list of instruments in the **Sorting** window strictly depends on an instrument filter applied, i.e. only the instruments set in the filter become available for sorting.

If you activate the filtering first, and then deactivate it, or turn off the filtering option in window, then all settings on the **Sorting** window will remain unchanged – until the filtering by instrument option remains unchanged, too.

Upon completion, you should confirm the changes you have made to the sorting order by pressing **Apply** or **OK**.

6.1.2.4. Contextual menu in the Financial instruments window

The standard context menu items are described in Chapter 11. Below you will find description for the particular **Financial instruments** window context menu items. There are:

- **Open options board**— opens the **Options board** window, with the filtering applied by the selected underlying asset. I. e., the **Options board** window displays only the options for the same underlying asset as the one in the string where cursor was placed upon opening the context menu. This context menu item is available only if you open the context menu from a string with option;
- **Open all trades** - opens the **All trades/ requests** window, with a filter applied according to the instrument selected in the **Financial instruments** window;
- **Open Order-book** – opens the **Order-book** window for the selected instrument. The window can be also opened by double-clicking an instrument with the left mouse button;
- **Open chart** – opens the **Tech. analysis** window, containing graphical chart for the selected instrument;
- **Add volatility curve** - adds the volatility curve chart into a separate window. This menu item is available only for options;
- **Information** - opens the **Information** window, containing data on the selected instrument;
- **Add order at <instrument code>** – opens the order adding window for the selected instrument (see section 6.2.3.1);
- **Request to NCC for <instrument code>** – opens the request to NCC window for the selected instrument (see section 6.2.5);
- **Add filter** or **Only 'parameter name'** – enables filtering according to the parameter where cursor was placed. The parameter name is available in a menu item. Please note, that the menu item is displayed only when the filtering option is available for the parameter selected. The list of the parameters can be found via the **Window settings/ Filters** context menu item; also, there you can specify the filtering parameters (see section 6.1.2.1);
- **Remove all filters** - removes all filters by all parameters. This context menu item is available only when the context menu has been opened from a column header and only when at least one filter has been applied;
- **Remove selected instruments from filter list** - removes the selected instrument from the filter list without opening the window settings. Please note that this command is available only when the filtering mode by instrument is on!
- **Manual sorting** - allows to manually sort records by dragging and dropping lines with cursor. To activate/deactivate this option you should check/uncheck the checkbox left of this context menu item. Also, it can be specified via the **Window settings/ Sorting** context menu item.

Please note, that actions associated with any the context menu items will be applied to a financial instrument under the mouse cursor. Please position it carefully!

6.1.3. Sessions window

The trading session is divided into the following parts (which have very few connection with time of day):

- the evening trading session — which lasts from 7:00 PM till 11:60 PM (Moscow time zone);
- the main trading session — which lasts from 10:00 AM till 6:45 PM (Moscow time zone).

During a single trading session, the same instruments are traded, and the same parameters are used to calculate collaterals.

Between the evening and the main trading sessions, the trading system is busy with many important things, such as clearing session, generating and sending reports, etc.

Before a new trading session starts, all expired instruments are removed from the system, and new instruments are added into. Please note, that the newly added instruments are not allowed for trading in the evening session (7:00 PM till 11:50 PM), while they are still visible in the trading system.

The **Sessions** window contains data on the current and next trading sessions.

The **Session** window can be opened via the **Tables/ Sessions** main menu item.

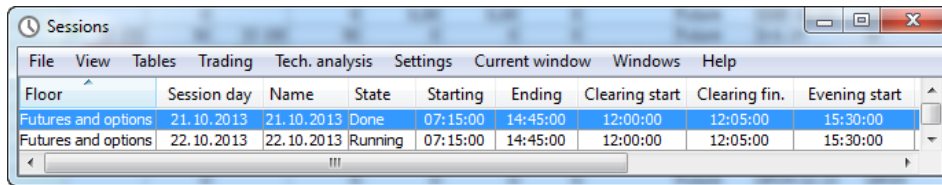

Fig. 6.6. The Sessions window

Tab. 6.3. Parameters in the Sessions window

Parameter	Details
Floor	Floor short name.
Session day	Session date.
Name	Session name.
State	Current state of session.
Starting	Session starting time.
Ending	Session ending.
Clearing start	Int. clearing starting time.
Clearing fin.	Int. clearing ending time.
Evening start	Add. evening session starting time.
Evening end.	Add. evening session ending time.
Morning start	Add. morning session starting time.
Morning end.	Add. morning session ending time.

The context menu contains only the standard commands, which are available for all windows – see Chapter 11.

6.1.4. News window

The News window allows you to view news from various news sources.

You can open the news window via the main menu item **Tables/ News**:

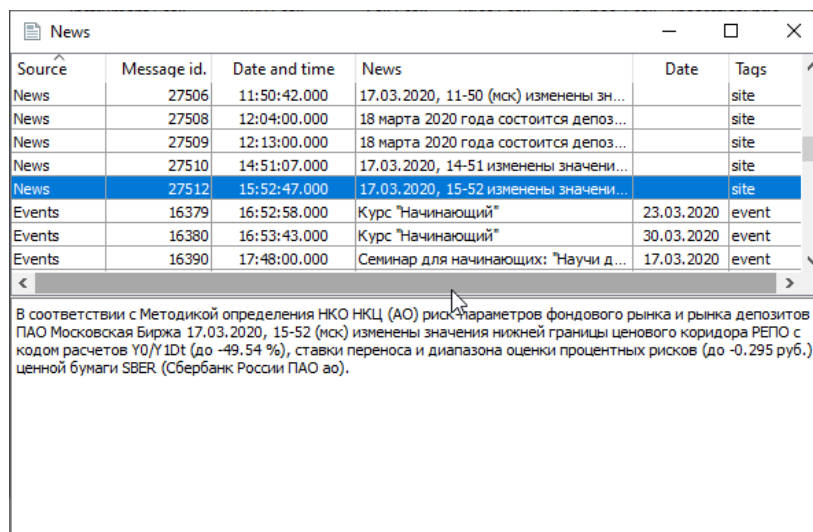

Fig. 6.7. News window

The news window is informational and does not provide for any special user actions, therefore the context menu contains only standard commands - see Chapter 11.

The window consists of two parts. At the top part, a list is displayed of all received news from all available news sources. In the lower part of the window, a news detailed description is displayed (the selected row is highlighted in blue).

Tab. 6.4. Parameters in news window

Parameter	Details
Source	News source
Message id.	Message identifier
Date and time	Message date and time
News	News headlines
Sheduled date	Event date
Tags	Tags

The records in the window can be sorted by any parameter in the forward and reverse directions. For information about the sorting settings see section 5.10.2.

The list of news sources can be customized by the user - see details in section 10.4.

Setting of connection parameters to the ISS server is performed in the tab **ISS service** of **Transport** section (**Settings/ Terminal settings** main menu item) - see section 10.17.2.

The **News** window allows to specify a sound scheme which plays every time a new string is added into the window. You can do this via the **Window settings** context menu item in the **Sounds** section, the **Play sound when adding a row** option. For more information see section 6.1.4.1.

6.1.4.1. Sound settings on adding a new string in the table

The **News** window allow to specify a warning sound signal on adding new string. This can be done via the **Window settings** context menu item in the **Sounds** section.

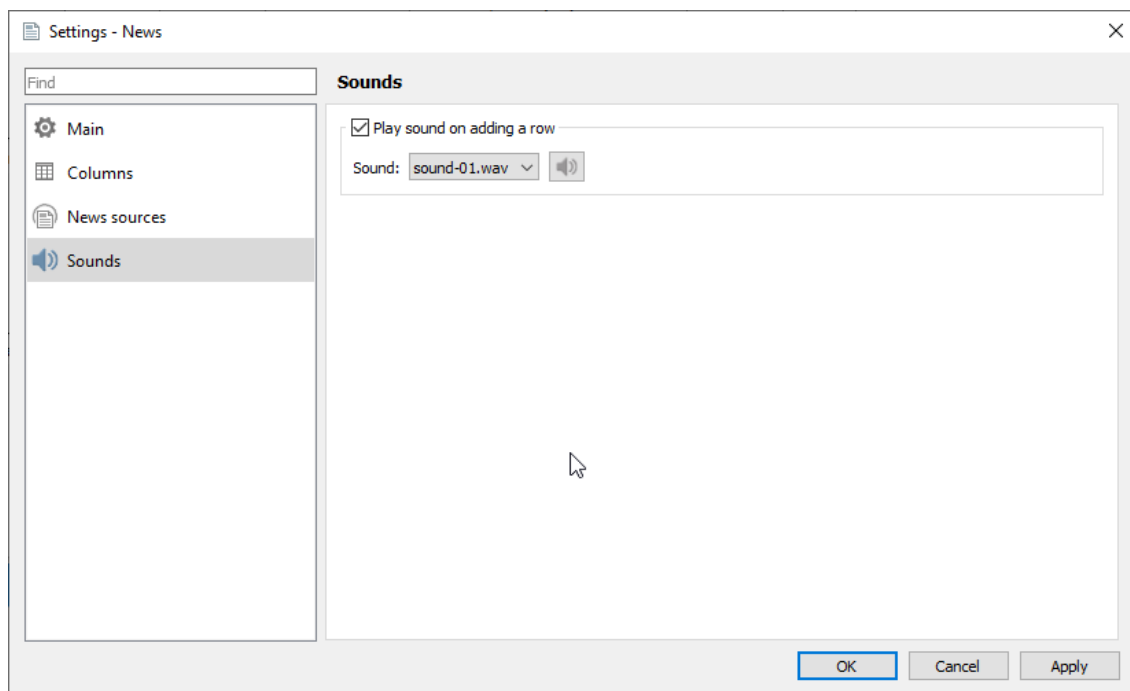

Fig. 6.8. Sound settings on adding a new string in the table

When the **Play sound on adding a row** option is set, then a sound will play every time a new string is being added into the **News** table.

The sound pattern can be selected in the **Sound** field from a drop-down list (with a preview option available for every sound pattern: to preview a sound, press the appropriate button next to the **Sound** field).

Please note, that the sound warning will be enabled only for the current window. By default, the sound warning is off, so you will have to enable it for every newly opened window.

6.1.5. Money

The **Money** information window displays the user's current money position for all available accounts. It can be opened via the **Trading/ Money** main menu item.

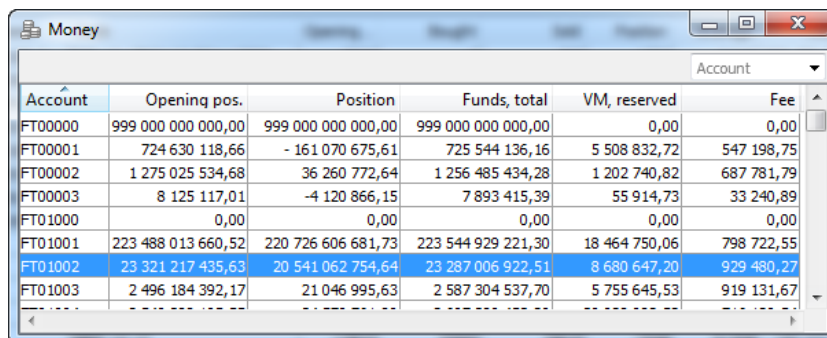

Account	Opening pos.	Position	Funds, total	VM, reserved	Fee
FT00000	999 000 000 000,00	999 000 000 000,00	999 000 000 000,00	0,00	0,00
FT00001	724 630 118,66	- 161 070 675,61	725 544 136,16	5 508 832,72	547 198,75
FT00002	1 275 025 534,68	36 260 772,64	1 256 485 434,28	1 202 740,82	687 781,79
FT00003	8 125 117,01	-4 120 866,15	7 893 415,39	55 914,73	33 240,89
FT01000	0,00	0,00	0,00	0,00	0,00
FT01001	223 488 013 660,52	220 726 606 681,73	223 544 929 221,30	18 464 750,06	798 722,55
FT01002	23 321 217 435,63	20 541 062 754,64	23 287 006 922,51	8 680 647,20	929 480,27
FT01003	2 496 184 392,17	21 046 995,63	2 587 304 537,70	5 755 645,53	919 131,67

Fig. 6.9. Money window

Tab. 6.5. Parameters in the Money window

Parameter	Details
Account	Client code.
Opening pos.	Funds at session start.
Position	Funds idle.
Funds, total	The total amount of money in the account.
VM, reserved	Variation margin for covered positions.
Fee	Collected fee.
Name	Account name.
Funds blocked	Funds blocked.
Variation margin for intraday clearing	Variating margin withdrawn/ deposited during intraday clearing session.

In the **Money** window, you can set filtering by account number. You can enter the account number into the field above the table manually or select it from the drop-down list. The number is case sensitive! Please note, that you should enter the whole number! The table than will display all the records belonging to the account number.

Account strings in the table are always sorted in lexicographic order, where b follows a, and 2 follows 1. You cannot sort data in the table in any other way.

The context menu contains only the standard commands, which are available for all windows, see Chapter 11.

6.1.6. Positions

The **Positions/ requests** information window displays the user's current position in instruments (securities) for all available accounts. The window can be opened via the **Trading/ (Positions/ requests)** main menu item.

Account	Instrument	Code	Openin...	Bought	Sold	Position	Average	Total	Variat
FT01004	RI92500BQ5	RTS-6.15M150515PA 92500	1	0	0	1	130	0,00	
FT03009	RI125000BE5	RTS-6.15M150515CA 125000	-2	0	0	-2	30	0,00	
FT04009	RI85000BR5	RTS-6.15M150615PA 85000	-120	0	0	-120	580	0,00	
FT04008	RI90000BQ5	RTS-6.15M150515PA 90000	-1	0	0	-1	80	0,00	
FT00001	RI50000BR5	RTS-6.15M150615PA 50000	-30	0	0	-30	50	0,00	
FT01009	RI70000BR5	RTS-6.15M150615PA 70000	-1	0	0	-1	210	0,00	
FT01005	RI80000BR5	RTS-6.15M150615PA 80000	63	0	0	63	390	0,00	
FT02006	RI110000BE5	RTS-6.15M150515CA 110000	-4	0	0	-4	680	0,00	
FT01009	RI115000BE5	RTS-6.15M150515CA 115000	-1	0	0	-1	190	0,00	
FT04002	RI120000BE5	RTS-6.15M150515CA 120000	-9	0	0	-9	70	0,00	
FT01009	RI85000BR5	RTS-6.15M150615PA 85000	-4	0	0	-4	580	0,00	
FT01002	CAM5	UCAD-6.15	-999	0	0	-999	1,2056	0,00	
FT03001	RI97500BQ5	RTS-6.15M150515PA 97500	1	0	0	1	390	0,00	
FT03008	RI90000BQ5	RTS-6.15M150515PA 90000	-7	0	0	-7	80	0,00	
FT01008	RI120000BE5	RTS-6.15M150515CA 120000	-18	0	0	-18	70	0,00	
FT01001	ED0.775BF5	ED-6.15M150615CA 0.775	-1	0	0	-1	0,9374	0,00	
FT00001	ED0.775BF5	ED-6.15M150615CA 0.775	1	0	0	1	0,9374	0,00	
Total			272884	15913	13640	275157		... 767,10	-145

Fig. 6.10. Positions/ requests window

Tab. 6.6. Parameters in the Positions/ requests window

Parameter	Details
Floor	Floor short name.
Account	Client code.
Instrument	Instrument short code.
Code	Instrument code.
Opening pos.	Amount of positions at session start.
Bought	Amount of contracts bought in session.
Sold	Amount of contracts sold in session.
Position	Current position.
Average	Average weighted position price.
Total	Net amount of funds spent on trades (in roubles).
Variation margin	Variational margin on futures accumulated by trades according to the current quote. Variational margin to be collected from account according to the instrument price limits.
Type	Type of instrument.
Order	Option expiration order id.
Execute	Number of positions for option expiration upon main clearing session and intraday clearing session. A negative value indicates that automatic exercise of in-the-money option contracts is disabled.
Date	Date and time of issuing option expiration order.
Int. clearing	Number of positions for option expiration upon intermediate clearing session.
Expiration	Instrument expiration date.
Underlying	Underlying asset code.
Theoretical price	Option contract theoretical price.
Volatility	Implied volatility
Delta	Rate of option premium change relative to underlying asset price.
Gamma	Rate of option delta change if underlying asset price has changed by 1.
Vega	Rate of option delta change if volatility has changed by 1.

Parameter	Details
Theta	Rate of option delta change relative to time (till expiration): amount of money the option loses per single day.

You can arrange records in the table by several columns: **Account**, **Instrument**, **Code** and **Date** in both directions. To switch between directions, click the left mouse button on a column header.

Records in the **Positions/ requests** window can be sorted by the client account number, etc. For more details see section 6.1.6.3.

The position table in the window can contain the total value string. You can turn it on and off using the button  of the local instrument panel. Another way to do this is to use the option **Show the total value row** (context menu item **Window settings/ sectionView**). The total value string contains the following parameters:

- variation margin value (including variation margin value with no restrictions for instrument prices limits);
- number of open positions (including the ones at the session start);
- (number of contracts bought and sold);
- (net value: the total amount for all trades).

You can configure the widget to select the option pricing model that will be displayed in the upper right corner of the window. You can do it via the **Window settings** context menu item (see section 11.1), setting the **Show in toolbar** option on the **Main** tab. By default, the widget is not displayed in the window. The choice of pricing model is actual for options and allows to choose the Black-Scholes or Bachelier (support for negative prices) model for calculations. If the widget is not displayed, then you can change the option pricing model via the **Window settings** context menu item, selecting the desired model from the drop-down list in **Option pricing model** field on the **Main** tab and then clicking on the **OK** or **Apply** button.



The context menu contains only the standard commands, which are available for all windows (see Chapter 11), as well as

- **Add order at <instrument code>** - opens the order adding form with the **Instrument** and **Account** fields filled in with values depending on the record. The **Floor** field is non-editable;
- **Request to NCC for <instrument code>** – opens the request to NCC window for the selected instrument (see section 6.2.5);
- **Exercise option** command - see section 7.2.1. The command is available for options only!;
- **Transfer position** - transfer position from one BF position to another (within the same CF). For more information see section 6.1.6.2;
- **Add filter/ Clear filter** command in the **Floor**, **Instrument** columns - see section 6.1.6.3;
- **Only** command in the **Type** column - see section 6.1.6.3;
- **Filters** menu item, in the **Type** column header - see section 6.1.6.3;
- **Remove all filters** command to remove all filters;
- **Copy the total value string into clipboard** - this menu item becomes visible only if the total value string is on. The output format is TXT.
- **Export the total value string** - his menu item becomes visible only if the total value string is on. The output format is CSV.

There are some commands moved to the local instrument panel. See section 6.1.6.1.

6.1.6.1. Toolbar of the Positions/ requests window

Tab. 6.7. Toolbar of the Positions/ requests window

Icon	Command	Details
	Transfer position	The button allows to transfer position from one BF position to another (within the same CF). For more information see section 6.1.6.2.
	Exercise option	Command allows to add option exercise order. This command is available only for records with options. For more information see section 7.2.1.
	Show the total value row	Turns the total value row on/off in the position table.

6.1.6.2. Transfer position from one BF position to another (within the same CF).

The **Positions/ requests** window allows to transfer positions from one client account to another within the same brokerage firm.

It is unable to transfer positions if:

- the donor account and recipient account belong to different BFs;
- VAT number/ID number are different for donor account and recipient account;
- unable to transfer positions to the BF account (type XXYY000).

You can transfer positions from the **Positions/ requests** window: by the following methods

- by pressing the  button;
- via the **Transfer position** context menu item opened from the **Positions/ requests** area. By placing the mouse cursor on the line with the donor account, the position transfer field will be filled in with this account data.

The button  and the context menu **Transfer position** mode may be inactive if you are trying to transfer funds from the BF, and not from the seven-digit client code.

The position transfer data are added into the **Transfer position** window:

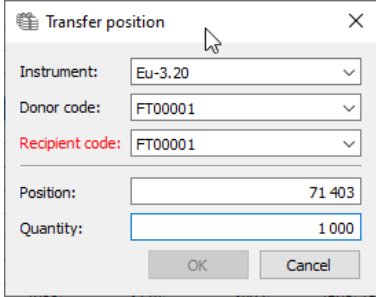

Fig. 6.11. Transfer position window

Tab. 6.8. Parameters in the Transfer position window

Parameter	Details
Floor	Trading floor short name

Parameter	Details
Instrument	Instrument short name to transfer position for.
Donor code	Donor account code.
Recipient code	Recipient account code. The recipient and donor accounts must belong to the same BF.
Position	Position amount on the donor account. This field is filled in automatically, and is not editable.
Quantity	Quantity to transfer. This value cannot exceed the one in the Position field.

All parameters are specified in accordance with the line, from which the **Transfer positions** has been opened. These data can later be changed by user by selecting values in the appropriate drop-down lists in every field.

The **Position** field is non-editable. Its value is calculated in accordance with the open position on the specified donor account.

To confirm changes and send the order into the trading system, press **OK**. Press **Cancel** to cancel the position transfer order.

The **OK** button may be inactive if the same code is specified for the donor and recipient. In this case, the code field will be highlighted in red.

After pressing **OK**, you will receive the confirmation dialog: "Are you sure you want to transfer position...for instrument...from account...to account...?" Answer **Yes** to confirm, or **No** to cancel.

In case of any failure with sending transfer order, you will receive a special message containing the error details. In this case, you should check the settings and retry adding the position transfer order.

6.1.6.3. Filtering in the Positions/ requests window

In the **Positions/ requests** window, you can set filtering by account number. You can enter the account number into the field above the table manually or select it from the drop-down list. The number is case sensitive! Please note, that you should enter the whole number! The table then will display all the records belonging to the account number.

In the table you can activate filtering by account number by entering it into the field in the right upper corner of the table (fig. 6.10). Please note, that search is always performed starting from the very first symbol in the account number, and the system does not recognize any other consequence of symbols. If a filter is applied to the table, the table will display all records containing the specified consequence of symbols in the beginning of the account number.

Filter settings are described in detail in section 5.10.4.

If a filter has been applied to a column (parameter) in the **Positions/ requests** window, the column header will be marked in bold.

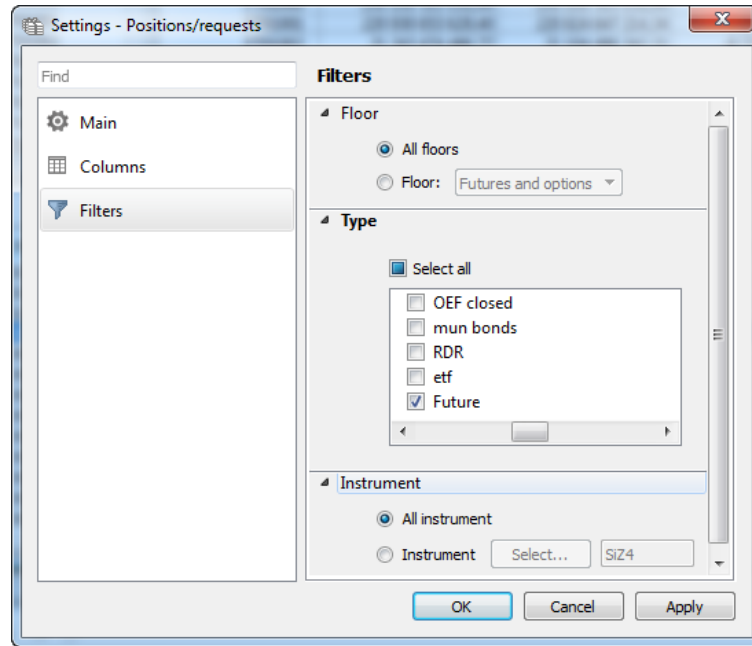

Fig. 6.12. Filtering settings in the Positions/ requests window

Tab. 6.9. Filter parameters in the 'Positions/ requests' window

Parameter	Details
Floor	<p>Filter by trading floor:</p> <p>If the Select all option is active, then the window will contain the positions for all trading floors.</p> <p>If the Select all option is inactive, the window will be empty. To select the trading floors you need, you should select them manually by checking the appropriate checkboxes. The list of available floors depends on the settings on the Transport tab (Settings / Terminal settings) - some records in the list may remain inactive (they highlighted gray color).</p>
Type	<p>Filter by instrument type.</p> <p>If the Select all option is active, then the window will contain the positions for all instruments.</p> <p>If the Select all option is inactive, the window will be empty. To select the instrument type you need, you should select them manually by checking the appropriate checkboxes.</p>
Underlying asset	<p>Filter by underlying asset.</p> <p>If the Select all option is active, then the window will contain the positions for all underlying assets.</p> <p>If the Select all option is inactive, the window will be empty. To select the underlying assets you need, you should select them manually by checking the appropriate checkboxes.</p>
Instrument	<p>Filter by instrument:</p> <ul style="list-style-type: none"> • All Instruments – all positions for all instruments; • Instrument – all positions for the selected instrument. Instruments can be selected in the Select Filter criteria instrument window (see section 5.11.1), which can be opened by pressing the Select button.
Account type	Filter by account type:

Parameter	Details
	<ul style="list-style-type: none"> • Select all - all positions for all accounts; • BF - all positions for BF; • Клиент - client positions only. Default value.

By default, the window displays only client positions for all floors.

You can deactivate filtering using one of the following methods:

- via the **Clear filter** context menu item, which should be opened from the **Floor, Instrument** columns header. If a filter has been applied to a column (parameter) in the **Floor** window, then the column header will be marked in bold;
- via selecting all parameters in the **Filters** context menu item, which should be opened from the **Type** column header;
- via the **Remove all filters** context menu item;
- via selecting all parameters in the **Filters** section of the **Window settings** context menu item.

6.1.7. Positions by settlement accounts

The **Positions by settlement accounts** information window displays the current positions aggregated by settlement accounts. The window can be opened via the **Trading/ Positions by settlement account** main menu item.

Settlement acco...	Instrument	Code	Opening...	Bought	Sold	Position	Average	Total	Variation margin	Type
70103	SIM0	SI-6.20	30741	10199	3047	37893	64 822,35...	-463 891 ...	14 823 680,00	Futures
70103	GDH0	GOLD-3.20	22576	1042	674	22944	1 578,143...	-32 859 3...	1 227 853,61	Futures
70103	MEH0	MOEX-3.20	125	79	0	204	11 300,43...	-896 413,...	9 500,00	Futures
70103	MINH0	MGNT-3.20	-2650	144	387	-2893	3 584,458...	865 586,00	95 200,00	Futures
70103	BRG0	BR-2.20	5210	1144	1784	4570	61,73264	24 432 5...	-334 636,46	Futures
70103	MFF0	1MFR-1.20	-50	0	0	-50	94,12000	0,00	0,00	Futures
70103	EuH0	Eu-3.20	46167	23528	17681	52014	70 443,69...	-412 987 ...	14 597 497,00	Futures
70103	SRH0	SBRF-3.20	-10634	1888	3370	-12116	25 478,37...	37 746 1...	803 950,00	Futures
70103	GZH0	GAZR-3.20	-8711	248	414	-8877	22 709,47...	3 775 83...	725 015,00	Futures
70103	MMIH0	MXI-3.20	-4681	32	163	-4812	3 078,248...	4 022 04...	400 631,50	Futures
70103	O4H0	OFZ4-3.20	-24	0	0	-24	10 075,00...	0,00	0,00	Futures

Fig. 6.13. 'Positions by settlement accounts' window

Tab. 6.10. Parameters in the 'Positions by settlement accounts' window

Parameter	Details
Floor	Floor short name.
Settlement account	NCC settlement account.
Instrument	Instrument short code.
Code	Instrument code.
Opening pos.	Amount of positions at session start.
Bought	Amount of contracts bought in session.
Sold	Amount of contracts sold in session.
Position	Current position.
Average	Average weighted position price.

Parameter	Details
Total	Net amount of funds spent on trades (in roubles).
Variation margin	Variational margin, accrued by trades and calculated by the restricted current quote.
Type	Type of instrument.
Expiration	Instrument expiration date.
Underlying	Underlying asset code.
Theoretical price	Option contract theoretical price.
Volatility	Implied volatility
Delta	Rate of option premium change relative to underlying asset price.
Gamma	Rate of option delta change if underlying asset price has changed by 1.
Vega	Rate of option delta change if volatility has changed by 1.
Theta	Rate of option delta change relative to time (till expiration): amount of money the option loses per single day.

You can arrange records in the table by any of the parameters in both directions. To switch between directions, click the left mouse button on a column header.

Records in the **Positions by settlement accounts** window can be sorted by the settlement account, etc. For more details see section 6.1.7.1.

You can configure the widget to select the option pricing model that will be displayed in the upper right corner of the window. You can do it via the **Window settings** context menu item (see section 11.1), setting the **Show in toolbar** option on the **Main** tab. By default, the widget is not displayed in the window. The choice of pricing model is actual for options and allows to choose the Black-Scholes or Bachelier (support for negative prices) model for calculations. If the widget is not displayed, then you can change the option pricing model via the **Window settings** context menu item, selecting the desired model from the drop-down list in **Option pricing model** field on the **Main** tab and then clicking on the **OK** or **Apply** button.

The context menu contains only the standard commands, which are available for all windows (see Chapter 11).

6.1.7.1. Filtering in the 'Positions by settlement accounts' window

In the **Positions by settlement accounts** window, you can set filtering by SA account number. You can enter the account number into the field above the table manually or select it from the drop-down list. The number is case sensitive! Please note, that you should enter the whole number! The table then will display all the records belonging to the account number.

In the table you can activate filtering by account number by entering it into the field in the right upper corner of the table (fig. 6.13). Please note, that search is always performed starting from the very first symbol in the account number, and the system does not recognize any other consequence of symbols. If a filter applied to the table, the table will display all records containing the specified consequence of symbols in the beginning of the account number.

Filter settings are described in detail in section 5.10.4.

If a filter has been applied to a column (parameter) in the **Positions by settlement accounts** window, the column header will be marked in bold.

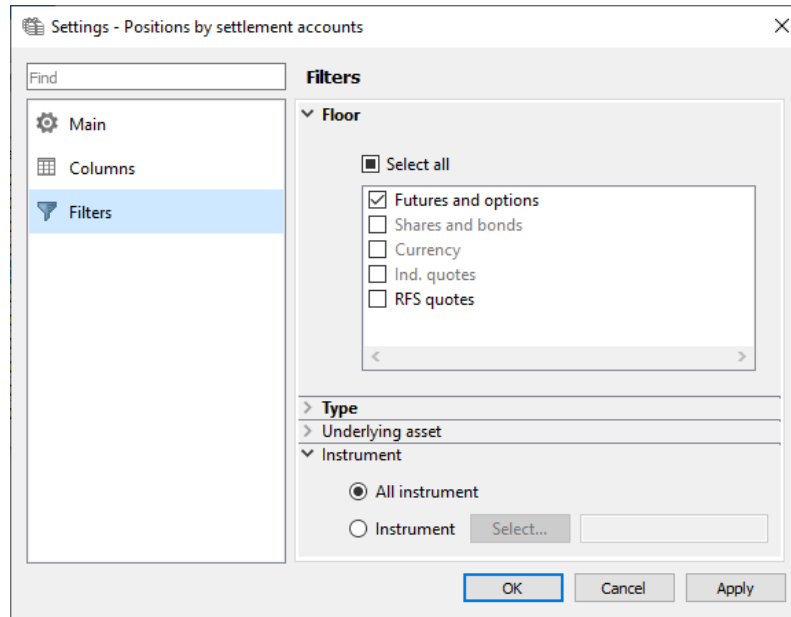

Fig. 6.14. Filtering settings in the 'Positions by settlement accounts' window

Tab. 6.11. Filter parameters in the 'Positions by settlement accounts' window

Parameter	Details
Floor	<p>Filter by trading floor:</p> <p>If the Select all option is active, then the window will contain the positions for all trading floors.</p> <p>If the Select all option is inactive, the window will be empty. To select the trading floors you need, you should select them manually by checking the appropriate checkboxes. The list of available floors depends on the settings on the Transport tab (Settings / Terminal settings) - some records in the list may remain inactive (they highlighted gray color).</p>
Type	<p>Filter by instrument type.</p> <p>If the Select all option is active, then the window will contain the positions for all instruments.</p> <p>If the Select all option is inactive, the window will be empty. To select the instrument type you need, you should select them manually by checking the appropriate checkboxes.</p>
Underlying asset	<p>Filter by underlying asset.</p> <p>If the Select all option is active, then the window will contain the positions for all underlying assets.</p> <p>If the Select all option is inactive, the window will be empty. To select the underlying assets you need, you should select them manually by checking the appropriate check-boxes.</p>
Instrument	<p>Filter by instrument:</p> <ul style="list-style-type: none"> • All Instruments – all positions for all instruments; • Instrument – all positions for the selected instrument. Instruments can be selected in the Select Filter criteria instrument window (see section 5.11.1), which can be opened by pressing the Select button.
Account type	<p>Filter by account type:</p> <ul style="list-style-type: none"> • Select all - all positions for all accounts;

Parameter	Details
	<ul style="list-style-type: none"> • BF - all positions for BF; • Клиент - client positions only. Default value.

By default, the window displays only client positions for all floors.

You can deactivate filtering using one of the following methods:

- via the **Clear filter** context menu item, which should be opened from the **Floor, Instrument** columns header. If a filter has been applied to a column (parameter) in the **Floor** window, then the column header will be marked in bold;
- via selecting all parameters in the **Filters** context menu item, which should be opened from the **Type** column header;
- via the **Remove all filters** context menu item;
- via selecting all parameters in the **Filters** section of the **Window settings** context menu item.

6.2. Orders

This section overviews the following aspects in working with orders:

- **Your orders/ requests** window [g_6_2_1];
- **Order-book** window;
- adding orders;
- removing orders;
- iceberg orders;
- request to NCC;
- indicative quotes;
- synthetic orders;
- postponed orders (batch entry);
- dynamical order adding;
- unprocessed orders;
- Risk balancing;
- **Messages** window.

6.2.1. Your orders/ requests window

The **Your orders/ requests** window contains only the orders added by your brokerage firm or the OTC orders addressed to your firm.

The window can be opened by the following methods :

- via the **Tables/ Your orders/ requests** menu item,

- from the instrument panel, by pressing the  button.

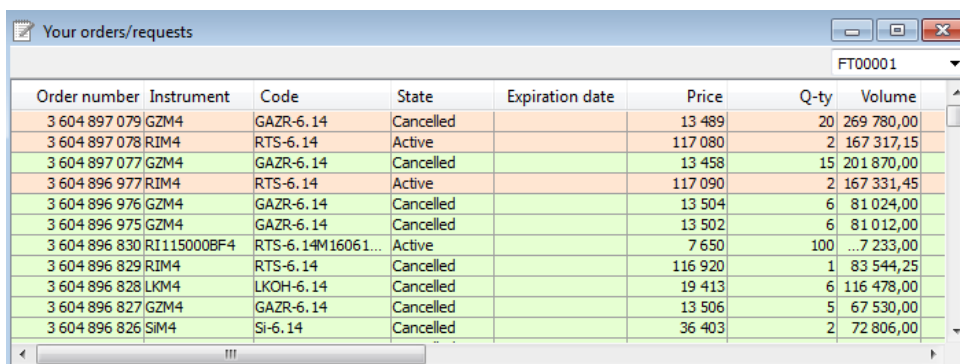

Order number	Instrument	Code	State	Expiration date	Price	Q-ty	Volume
3 604 897 079	GZM4	GAZR-6.14	Cancelled		13 489	20	269 780,00
3 604 897 078	RIM4	RTS-6.14	Active		117 080	2	167 317,15
3 604 897 077	GZM4	GAZR-6.14	Cancelled		13 458	15	201 870,00
3 604 896 977	RIM4	RTS-6.14	Active		117 090	2	167 331,45
3 604 896 976	GZM4	GAZR-6.14	Cancelled		13 504	6	81 024,00
3 604 896 975	GZM4	GAZR-6.14	Cancelled		13 502	6	81 012,00
3 604 896 830	RI115000BF4	RTS-6.14M16061...	Active		7 650	100	...7 233,00
3 604 896 829	RIM4	RTS-6.14	Cancelled		116 920	1	83 544,25
3 604 896 828	LKM4	LKOH-6.14	Cancelled		19 413	6	116 478,00
3 604 896 827	GZM4	GAZR-6.14	Cancelled		13 506	5	67 530,00
3 604 896 826	SIM4	SI-6.14	Cancelled		36 403	2	72 806,00

Fig. 6.15. Your orders/ requests window

Tab. 6.12. Parameters in Your orders/ requests window

Parameter	Details
Floor	Floor short name.
Order number	Order sequential number.
Instrument	Instrument short code.
Code	Instrument code.
State	Order status (active, executed, removed).
Expiration date	Order expiration date.
Price	Order price.
Q-ty	Amount in operation.
Volume	Order price (money).
Available	Remaining amount in order.
Time	Time of placing order.
Account	Client code.
Code of firm	Code of firm which owns the order.
Session	Session name.
Board	Instrument board.
Buy/ sell	Order type.
Login	User login.
External id.	External number of transaction.
Comment	Order additional details.
Counterparty account	Code of client who receives the order.
Counterparty	Code of firm which receives the order.
Rate	Order rate in percent.
Swap price	Order rate in point.
Cancel time	Order cancel time.
Underlying	Underlying asset code.
Yield	Yield on futures on interest rates.
Initial number	The order's ID number, assigned to an order upon its initial listing in the trading system. This initial ID number remains the same, no mat-

Parameter	Details
	ter how many times the order is relisted, so that it would be easier to find an unmatched order later after it has been relisted for another trading session.
Master login	Master login.
Request to NCC	Request to NCC Possible values: <ul style="list-style-type: none"> • Yes - request to NCC • No - standard order.
Order type	Order types generated by the OTC SPECTRA subsystem and other special order types
Liquidity stream ID	Liquidity stream ID
Seconds left	Time remaining before automatic cancelation of the quote (in seconds). Table cell for RFS quote in the stream close to expiration (less than 60 seconds) - is highlighted in red (by default).
Auto-confirmation	Automatic confirmation flag: <ul style="list-style-type: none"> • Yes - with auto-confirmation (indicative trade will be concluded with auto-confirmation (without request for confirmation from the provider) • No - confirmation of the indicative trade will be requested from the liquidity provider Used for liquidity provider quotes in RFS streams.
Visible order	The ordinal number of the iceberg visible part in the system
Visible amount	Number of instrument units in the iceberg visible part
Visible available quantity	Available quantity of instrument in the iceberg visible part
Variance	Variance amplitude for a random addition for the iceberg visible part (in contracts)
Disclose part	The fixed number of units of the instrument in the iceberg visible part

Some different modes of loading data into the **Your orders/ requests** window are available:

- when the **Load your orders history** option is active, it allows to load all available orders – (**Settings/ Terminal settings/ Transport** in the **Streams** section);
- when **Load your orders history** is inactive, it allows to load the **Your orders/ requests** window faster, as only the active orders will be loaded.

You can specify different modes of storing inactive orders (settled or canceled):

- do not store inactive orders mode. To activate this mode you should switch off the **Store inactive order** option (**Settings/ Terminal settings/ Database**);
- store all inactive orders mode. To activate this mode you should switch on the **Store inactive order** option (**Settings/ Terminal settings/ Database**);
- store limited number of inactive orders. To activate this mode you should switch on the **Store inactive order** option (**Settings/ Terminal settings/ Database**) together with the **Amount of orders** option and specify number of inactive orders to be stored.

The orders in the window can be sorted according to the time the orders have been added into the trading system. For information about the sorting settings see section 5.10.2.

The **Your orders/ requests** window provides possibility for contextual search (see section 5.10.3). The search can be activated by pressing the **Ctrl+F** key combination.

The list of orders in the **Your orders/ requests** window can be arranged by account and other parameters. For more information see section 6.2.1.1.

If the list of orders has been arranged in accordance with a parameter, the appropriate column's header will be marked in bold.

By double-clicking an order in the **Your orders/ requests** window with the left mouse button, you can do the following (depending on the order status):

- non-active order – add a new order into the system using a special window. By default, the new order's parameters will be taken from the non-active one;
- active order – cancel the order.

You can also cancel an order by using the **Cancel order** context menu item or by pressing the **Delete** button on your keyboard. Before cancelling, you should place the mouse cursor over the active order you are going to cancel.

Full list of possible commands executed in the **Your orders/ requests** window see section 6.2.1.2.

The **Your orders/ requests** window allows to specify different colour schemes for the buy and sell strings (green and red, by default) via the **Window settings** context menu item of the **View** section, the **Highlight strings** command. You can choose some other colour schemes in the **Window settings/View/ Colours settings...** context menu item (see section 11.2).

Table cell **Seconds left** for RFS quote in the stream close to expiration (less than 60 seconds) is highlighted in red (by default).

Also, the **Your orders/ requests** window allows to specify a sound scheme which plays every time a new string is added into the window. You can do this via the **Window settings** context menu item in the **Sounds** section, the **Play sound when adding a row** flag. For more information see section 6.2.1.3.

6.2.1.1. Filters in the Your orders/ requests window

In the **Your orders/ requests** window, you can set filtering by account number. You can enter the account number into the field above the table manually or select it from the drop-down list. The number is case sensitive! Please note, that you should enter the whole number! The table than will display all the records belonging to the account number. Please note, that the filtering is applicable only to the records displayed in the window right now. I.e., it does not affect the filtering settings made via the **Window settings** menu item.

Filtering schemes in the **Your orders/ requests** window can be specified in the following ways:

- via the **Add filter** context menu item. Filtering will be applied according to parameter under the cursor. If a parameter under the cursor is not applicable for filtering, then this menu item will be absent in the context menu. The list of parameters applicable for filtering can be found via the **Window settings/ Filters** context menu item;
- via the **Filters** context menu item, available from the following columns' headers: **Remains, Status, Buy/sell**. To activate filtering, you should select the needed parameters in the drop-down list by checking the checkboxes next to each parameter name;
- via the **Window settings** context menu item in the **Filters** section.

You can apply filtering by a particular instrument in the following ways:

- via the **Select instrument** context menu item, which is available only from the **Instrument** column's header. The **Select instrument** window appears on the screen (see section 5.11.1), where you can select a needed instrument. After selection is done, the **Your orders/ requests** window will contain only the orders for the selected instrument;

- via the **Add filter** context menu item, when the context menu is opened from a cell in the **Instrument** column (the filter will be applied by the instrument code in the cell);
- via the **Window settings** context menu item of the **Filters** section.

If a filter has been applied to a column in the **Your orders/ requests** window, then the column's header will be marked in bold.

You can apply all the possible filtering options at once via the **Window settings/ Filters** context menu item:

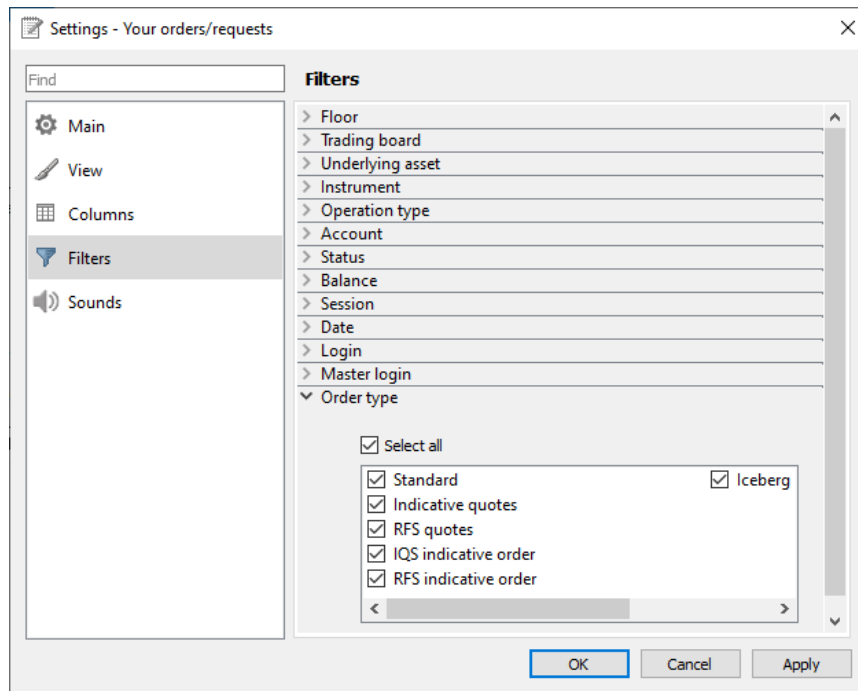

Fig. 6.16. Filtering settings in the Your orders/ requests window

Tab. 6.13. Filtering parameters in the Your orders/ requests window

Parameter	Details
Floor	<p>Filter by trading floor.</p> <p>If the Select all option is active, then the window will contain all orders for all trading floors. If the Select all option is inactive, the window will be empty. To select the floors you need, you should select them manually by checking the appropriate checkboxes. The list of available floors depends on the settings on the Transport tab (Settings / Terminal settings) - some records in the list may remain inactive (they highlighted gray color).</p>
Board	<p>Filtering by trading board. If the Select all option active, the window will contain all orders for all trading boards.</p> <p>To select some particular trading boards, you should check the checkbox next to the board name.</p>
Underlying asset	<p>Filtering by underlying assets. If the Select all option active, the window will contain all orders for all underlying assets.</p> <p>To select some particular underlying assets, you should check the checkbox next to the underlying assets codes.</p>
Instrument	<p>Filtering by instrument:</p> <ul style="list-style-type: none"> • All Instruments – all orders for all instruments;

Parameter	Details
	<ul style="list-style-type: none"> • Instrument – all orders for the selected instrument. Instruments can be selected in the Select instrument window (see section 5.11.1), which can be opened by pressing the Select button.
Operation type	<p>Filtering by operation type:</p> <ul style="list-style-type: none"> • Buy – only user's buy orders are displayed; • Sell – only user's sell orders are displayed. <p>You can select one of the operation types or both at once.</p>
Account	<p>Filtering by client's account. If the Select all is active, the window will contain all orders for all client's accounts.</p> <p>To select some particular user's accounts, you should check the checkbox next to the user's account name.</p>
Status	<p>Filtering by order status:</p> <ul style="list-style-type: none"> • Active – only user's active orders; • Removed by trading system – only orders removed by trading systems for any reason; • Expired – only expired orders; • Declined by counterparty – only orders declined by counterparty (negotiated orders); • Success – only executed orders; • Waiting – only yet non-active orders; • Cancelled – only user cancelled orders. <p>You can select any combination of the options above.</p>
Balance	<p>Filtering by order execution status:</p> <ul style="list-style-type: none"> • Fully executed – only fully executed orders; • Partially executed – only part executed orders; • Not executed – only non-executed orders.
Session	<p>Filtering by session:</p> <ul style="list-style-type: none"> • Active – the orders only for the current active session; • Inactive – the orders for available done session.
Date	<p>Filtering by date:</p> <ul style="list-style-type: none"> • All dates – user's orders for the current and previous active sessions; • Today – only orders for today's sessions; • Today and tomorrow – orders for today's and yesterday's sessions; • Between - orders for a particular period of time. You can specify period in the following ways: <ul style="list-style-type: none"> • the From and till options are not set – all available dates;

Parameter	Details
	<ul style="list-style-type: none"> only the From option is set – the dates starting from the date specified till today; only the till option is set – the dates starting from the oldest available date till the date specified; the both From and till options are set – all dates starting from the date specified in the From field till the one specified in the till field.
Login	Filtering by login: <ul style="list-style-type: none"> All logins – all orders added by all logins; Login – only the orders added by a particular login. The login can be selected in the drop-down list
Master login	Filtering by master login: <ul style="list-style-type: none"> All logins – all master logins; Login – the login can be selected in the drop-down list
Order type	Filtering by order type: <ul style="list-style-type: none"> Standard - all client trades except technical Indicative quotes - IQS orders in Spectra system RFS quotes - RFS orders in Spectra system IQS indicative order - IQS indicative quotes in OTC system RFS indicative order - RFS indicative quotes in OTC system Iceberg - Iceberg orders

You can remove filter by the following ways:

- via the **Clear filter** context menu item – allows to remove the filter applied by the current column parameter (the column header will be marked in bold). The item is available in the context menu only when the filtering has been applied;
- via the **Filters** context menu item, when the context menu is opened from the **Remains**, **Status** and **Buy/sell** columns. To remove a filter, you should uncheck the checkbox next to the filter name;
- via the **Window settings/ Filters** context menu item. To remove filter, set all parameters as visible;
- via the **Remove all filters** context menu item - but all filters will be removed.

Please note, that if you closed the **Your orders/ requests** window and then opened again, the filter settings you had applied will be lost. To prevent it, you should save the workspace configuration before closing the window as the default configuration using the **Current window/ Save by default** main menu item.

6.2.1.2. Context menu in the Your orders/ requests window

The standard context menu items are described in Chapter 11. Below you will find description of the particular **Your orders/ requests** window context menu items. There are:

- Add/ order** – opens the standard form for adding orders into the trading system;
- Request to NCC for <instrument code>** – opens the request to NCC window for the selected instrument (see section 6.2.5);

- **Change order** - opens **Change order** window, where you can change the price and quantity of order, You can not change the order direction. You can change only the price for iceberg orders;
- **Cancel** – allows to cancel the active order or request to NCC under the cursor. For orders in a non-active status or orders for past sessions of this menu item missing. Please note that only Clearing Participants are allowed to cancel requests to NCC!
- **Open all trades** - opens the **All trades/ requests** window, with a filter applied according to the selected instrument;
- **Open Order-book** – opens the Order-book window for the current instrument;
- **Open chart** – creates a graphical chart for the current instrument in the **Tech. analysis** window;
- **Add volatility curve** - adds the volatility curve chart into a separate window (see section 7.3). This menu item is available only for options;
- **Information** - opens the **Information** window for the selected instrument;
- **Add filter** – enables filtering according to the parameter where cursor was placed. The parameter name is available in a menu item. Please note, that the menu item is displayed only when the filtering option is available for the parameter selected. The list of the parameters can be found via the **Window settings/ Filters** context menu item; also, there you can specify the filtering parameters (see section 6.2.1.1);
- **Only 'parameter name'** - the menu item, available from the **Remains, Status** and **Buy/sell** column cells. Allows to add a filter according to the parameter name under the cursor (the parameter name is displayed in the context menu);
- **Show all** - removes all filters. Please note, that this menu item is available only in the context menu opened from the column header applicable for multi-filtering option (when more than one filter parameters can be applied);
- **Select instrument** - opens the **Select instrument** window. After selecting an instrument, the filtering will be enabled according to the selected one instead of any other instrument selected before, if it was. This menu item is available only in context menu opened from the **Instrument** column;
- **Clear filter** – allows to remove the filter applied by the current column parameter (the column header will be marked in bold). The menu item is available in the context menu only when the filtering has been applied;
- **Remove all filters** - removes all filters by all parameters. The menu item is available in the context menu only when the filtering has been applied;
- **Filters** – the menu item, available from the **Remains, Status** and **Buy/sell** column cells. In the drop-down list you should select the filtering parameters by checking the checkbox next to each parameter name. Please note, that via this menu item, you can add or remove only a single parameter at once. For more options please use the **Window settings/ Filters** context menu item – see section 6.2.1.1.

6.2.1.3. Sound settings on adding a new string in the table

The **Your orders/ requests** and **Your trades/ requests** windows allow to specify a warning sound signal on adding new strings. This can be done via the **Window settings** context menu item in the **Sounds** section.

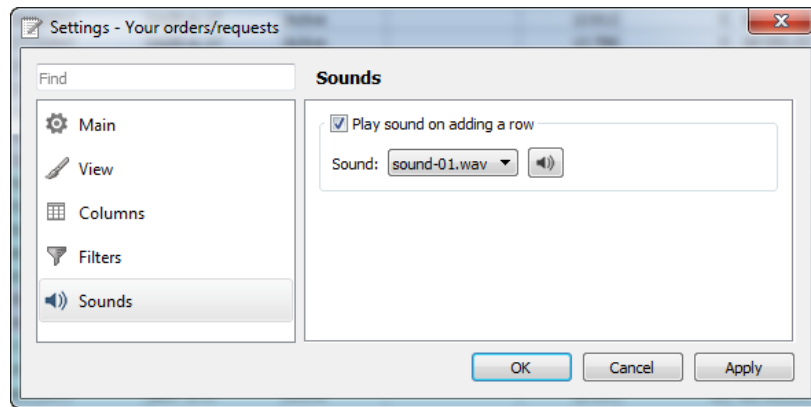

Fig. 6.17. Sound settings on adding a new string in the table

When the **Play sound on adding a row** option is set, then a sound will play every time a new string is being added into the **Your orders/ requests** (or **Your trades/ requests**) table.

The sound pattern can be selected in the **Sound** field from a drop-down list (with a preview option available for every sound pattern: to preview a sound, press the appropriate button next to the **Sound** field).

Please note, that the sound warning will be enabled only for the current window, and according to the current filter settings. I. e., if a newly added string does not contain an instrument within the filter range, no sound warning will play. By default, the sound warning is off, so you will have to enable it for every newly opened window.

6.2.1.4. Change order

You can change order via **Change order** context menu item in **Your orders/ requests** window **Change order**. You can change the order in status **Active** only. There is a special form **Change order** for change the order parameters:

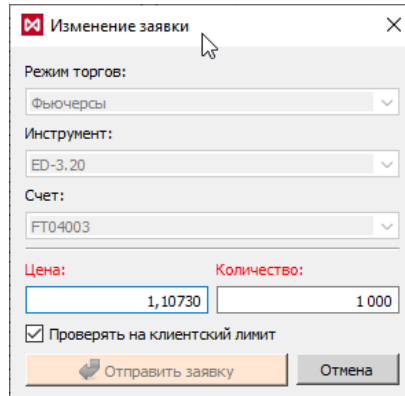

Fig. 6.18. 'Change order' window

The form fields are automatically filled in with parameters of the order under the mouse cursor.

You cannot change the order direction, but you can change **Price** and **Quantity**, as well as you can remove or set the flag **Verify client limit**. For iceberg orders, you can only change the **Price**, it is impossible to change the iceberg order volume.

The button **Send order** becomes available after editing at least one parameter. Pressing this button places the changed order into the trading system.

The button **Cancel** cancels the submission of the changed order into the trading system.

After pressing the **Send order** button, a confirmation message "Are you sure you want to change the buy order from account...number...? The new order volume will be less than the specified by the matched part size. You specified quantity ... and the price ..." appears on the screen. Press **Yes** to add the changed order into the trading systems, or no **No** to cancel – the **Change order** window then remains open.

You can check the **Do not show next time** checkbox to disable the confirmation message. You can specify the change order confirmation message settings via the **Order adding confirmation** option in the **Settings/ Terminal settings** window, the **Main** section, **Confirmations** tab.

6.2.2. Order-book

The order queue for a particular instrument can be viewed in the **Order-book** window. You can open it in the following ways:

- via the **Tables/ Order-book for instrument** main menu item. You can select an instrument in the following ways:
 - from the favorite instruments list;
 - from the **Favorite instruments** window (see section 5.11.2);
 - from the **Select instrument** window (see section 5.11.1);
- by pressing an appropriate instrument button in the instrument panel;
- from the **Financial instruments, Options board, Your trades/ requests** and **All trades/ requests** windows by double-clicking the instrument name in a string;
- via the **Open Order-book** context menu item;
- from the **Your orders/ requests** functional window via the **Open Order-book** context menu item.

Order-book window can be opened only for anonymous instruments. For instruments traded in the negotiated mode, the window does not open.

The Order-book window contains the current session orders only. Quotes parameters displayed in the **Order-book** window are described below. - see tab. 6.15.

There can be more than one **Order-book** windows open for the same instrument at once.

Every Order-book window can be renamed using the **Window settings** context menu item of the **Main** section; to change the window name, enter its new name into the **Name** field. If you rename a window, and then select another instrument, then the window name will change again according to the new instrument name. If a desktop configuration contains a window for an instrument which is not traded in the current session, this window will be blank.

There are three view modes for the Order-book window:

- **standard** – see section 6.2.2.2.1;
- **narrow** – see section 6.2.2.2.2;
- **wide** – see section 6.2.2.2.3.

You can select a display mode via the **Window settings** context menu item in the **View** section – see section 6.2.2.2.

Both the **standard** and the **narrow** modes have their own special submodes:

- **Rarefied** - all possible price values are displayed according to the specified price step – see section 6.2.2.2.4;
- **Save centre** – the best buy and sell prices are docked to the table centre – see section 6.2.2.2.5.

If none of the submodes has been selected, then the best buy and sell prices may move against the table centre and hide beyond the window borders; in this case, use the vertical scroll-bar to scroll table up and down.

The **Shift+R** key combination allows to dock the Order-book centre in case you haven't done it yet.

The buy and sell prices strings can be highlighted in different colours (green and red, by default). You can specify a colour scheme via the **Window settings** context menu item in the **View** section by pressing the **Colour settings** button.

If a price meets an order, then the price value will be marked in bold (the **Price** column).

The Order-book window appearance can be specified via the **Window settings** context menu item - see Chapter 11.

By double-clicking an order with the left mouse button, the order adding window will open (if the one-click trading mode is off). By default, the form contains parameters of the selected order; you can manually edit the order parameters before adding it into the trading system.

For your convenience, in the Order-book window you can highlight a range of orders according to their prices or volumes - see section 6.2.2.3.



For every **Order-book** window, there is the **one-click trading** mode is available (see section 6.2.2.5 and section 6.2.2.6). Using this mode, you can add orders into the trading system in a very fast way, without using the instrument panel and menus.

If a one-click trading account has been specified, the Order-book window will display only the orders added from this account.

The client account code number is displayed between the order-book table and the window header. You can select client account codes from the drop-down list without entering the windows settings section.

6.2.2.1. Toolbar of the Order-book window

Tab. 6.14. Toolbar of the Order-book window

Icon	Command	Details
	Show/ hide order panel	Used to quickly hide/display the orders panel (see section 6.2.2.7).
	Switch to Indicative quotes/ Switch to Futures and options	Switches the window to Indicative Quotes mode and back (see. section 6.2.6). The button is available only for instruments allowed for IQS.

6.2.2.2. Setting the Order-book window appearance

You can specify the Order-book window appearance via the **Window settings / View** context menu item:

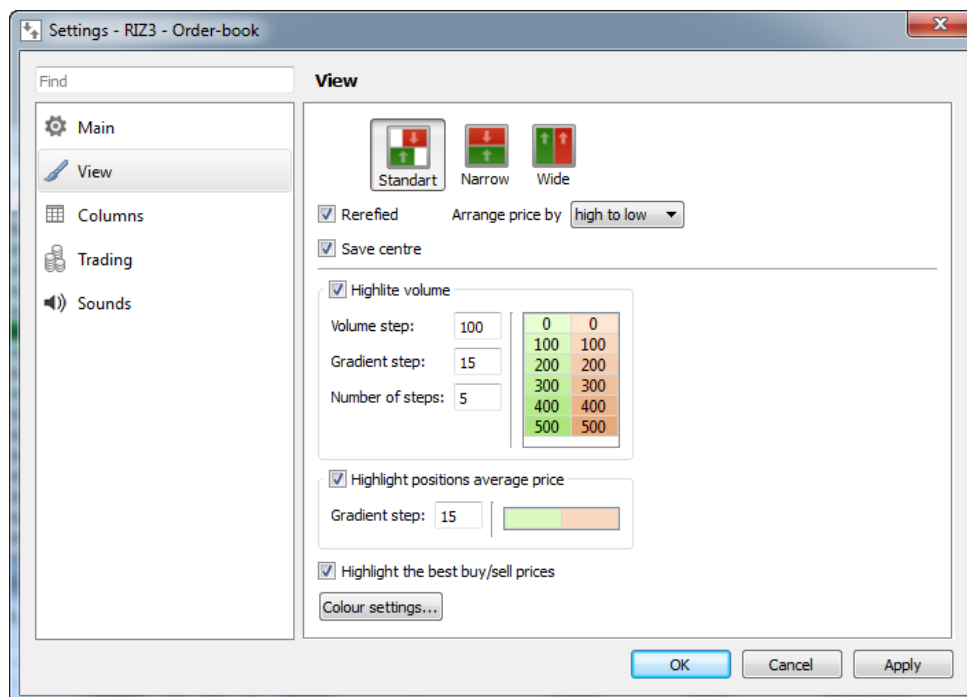

Fig. 6.19. Setting the Order-book window appearance

There are three view modes for the Order-book window:

- **standard** – see section 6.2.2.2.1;
- **narrow** – see section 6.2.2.2.2;
- **wide** – see section 6.2.2.2.3.

To select a view mode, place the mouse cursor over it and press the left mouse button. To confirm the selection, press **Apply** or **OK**.

Both the **standard** and the **narrow** modes have their own special submodes:

- **Rarefied** – see section 6.2.2.2.4;
- **Save center** - see section 6.2.2.2.5;
- **Arrange price by** descending or by ascending.

The **Highlight volume** option allows to highlight a range of orders according to their volumes - see section 6.2.2.3.

The **Highlight the best buy/sell prices** option allows to highlight the cell containing the best buy and sell price values.

The **Highlight positions average price** option allows to highlight the cells containing the average price values for the current instrument. The option is available in the **Rarefied** mode only. The position price is always rounded up to the worst value for trader, i. e. if the current user's price is positive, than the price will be rounded up upwards, and if the current user's price is negative, than the price will be rounded up downwards. The highlight colour depends only on the value sign (green if positive, red if negative). The **Gradient step** option allows to adjust intensity of highlighting (the higher the gradient value is, the deeper the highlight colour will be).

The **Colour settings** button allows to open the **Colours** window which is used for specifying the general settings for the adding orders window - for more details see section 10.5.

6.2.2.2.1. Standard mode

The standard window configuration can be recognized with the way of displaying orders: the buy and sell orders are divided into two queues. The orders in the window can be adjusted by price, either in the descending or in the ascending way. To adjust orders by price, click the left mouse button on the column's header - see section 5.10.2) or use the **Window settings/ View/ Arrange price by** context menu item.

The best prices are always displayed in the center of the Order-book window, regardless of sorting order.

There are two view modes are available for the **Standard** configuration: the rarefied (see section 6.2.2.2.4) or the one with fixed centre (see section 6.2.2.2.5).

The buy and sell order queues in the window are shifted against each other.

Buy:yours	Buy:q-ty	Price	Sell:q-ty	Sell:yours
	1	115 600		
	38	115 610		
	30	115 620		
	9	115 630		
	61	115 640		
	10	115 650		
	7	115 670		
		115 690	6	
		115 700	182	
		115 710	37	
		115 720	8	1
		115 730	2	
		115 740	28	
		115 750	20	
		115 760	4	
		115 770	6	
		115 780	15	

Fig. 6.20. Order-book window. Standard mode

Tab. 6.15. Parameters in the Order-book window – Standard mode

Parameter	Details
Buy: synthetic volume	Buy: synthetic liquidity volume.
Buy: yours	Buy: Instruments quantity in your orders at the current price.
Buy: summary	Buy: Accumulated sell order.
Buy: qty	Buy: Total number of lots in orders at the given price.
Price	Price for instrument unit. The strings containing your orders are highlighted in bold.
Sell: qty	Sell: Total number of lots in orders at the given price.
Sell: summary	Sell: Accumulated sell order.
Sell: yours	Sell: Instruments quantity in your orders at the current price.
Sell: synthetic volume	Sell: Synthetic liquidity volume.
Buy: yours private	Buy: Instruments quantity in iceberg orders at the current price.
Yield	Yield on futures on interest rates.
Sell: yours private	Sell: Instruments quantity in iceberg orders at the current price.

6.2.2.2.2. Narrow mode

In the **Narrow** mode, the buy and sell order queues are visually separated from each other, having different background colours. The orders are not shifted against each other.

The orders in the window can be adjusted by price, either in the descending or in the ascending way. To adjust orders by price, click the left mouse button on the column's header - see section 5.10.2) or use the **Window settings/ View/ Arrange price by** context menu item.

The best prices are always displayed in the center of the Order-book window, regardless of sorting order.

There are two view modes are available for the **Narrow** configuration: the rarefied (see section 6.2.2.2.4) or the one with fixed centre (see section 6.2.2.2.5).

Price	Direction	Q-ty	Summary	Yours
115 610	Buy	22	135	
115 620	Buy	13	113	
115 630	Buy	12	100	
115 640	Buy	48	88	
115 650	Buy	7	40	
115 660	Buy	3	33	
115 670	Buy	23	30	
115 680	Buy	7	7	
115 710	Sell	3	3	
115 720	Sell	23	26	
115 740	Sell	3	29	
115 750	Sell	10	39	
115 760	Sell	26	65	1
115 770	Sell	23	88	
115 780	Sell	11	99	
115 790	Sell	12	111	
115 800	Sell	11	122	6

Fig. 6.21. The Order-book window. Narrow mode

Tab. 6.16. Parameters in the Order-book window – narrow mode

Parameter	Details
Price	Price for instrument unit. The strings containing your orders are highlighted in bold.

Parameter	Details
Yield	Yield on futures on interest rates.
Direction	Direction of orders at this price level.
Q-ty	Total number of lots in orders at the given price.
Summary	Accumulated sell/buy orders quantity. Accumulated number sell/buy orders up to this price level, starting from the best price and according to the orders within the current price range. The value presents the whole market volume.
Yours	Instruments quantity in your order at the current price.

6.2.2.2.3. Wide mode

In the **Wide** mode, the first string in the Order-book window contains the best buy and sell prices, the second one contains a bit worse values, and so on. There is no other options for to arrange orders.

The Rarefied and the 'fix-center' modes are not available in the **Wide** mode..

Buy:yours	Buy:summary	Buy:q-ty	Buy:price	Sell:price	Sell:q-ty	Sell:summary	Sell:yours
	2	2	115 850	115 860	2	2	
	9	7	115 840	115 870	74	76	
	43	34	115 820	115 880	100	176	
	73	30	115 810	115 890	83	259	
	80	7	115 800	115 920	7	266	
	84	4	115 790	115 940	15	281	1
	85	1	115 770	115 950	2	283	1
	100	15	115 760	115 960	14	297	
	102	2	115 750	115 970	46	343	
	341	239	115 740	115 980	8	351	
	377	36	115 730	115 990	9	360	
	384	7	115 720	116 000	24	384	
	391	7	115 710	116 010	23	407	
	414	23	115 700	116 020	200	607	
	415	1	115 690	116 040	1	608	
	428	13	115 680	116 060	19	627	
	449	21	115 670	116 080	2	629	

Fig. 6.22. Order-book window. Wide mode

Tab. 6.17. Parameters in the Order-book window – wide mode

Parameter	Details
Buy: yours	Buy: Instruments quantity in your order at the current price.
Buy: summary	Accumulated buy orders quantity. Accumulated number buy orders up to this price level, starting from the best price and according to the orders within the current price range. The value presents the whole market volume.
Buy: q-ty	Buy: Total number of lots in orders at the given price.
Buy: yield	Yield on futures on interest rates.
Buy:price	Buy: Price level. The levels at which there are your orders are allocated in bold.
Sell:price	Sell: Price level. The levels at which there are your orders are allocated in bold.
Sell: yield	Yield on futures on interest rates.

Parameter	Details
Sell: q-ty	Sell: Total number of lots in orders at the given price.
Sell: summary	Accumulated sell orders quantity. Accumulated number sell orders up to this price level, starting from the best price and according to the orders within the current price range. The value presents the whole market volume.
Sell: yours	Sell: Instruments quantity in your order at the current price.

6.2.2.2.4. Rarefied mode

The **Rarefied** view mode is available for the **Standard** and **Narrow** Order-book modes, where all possible price values are displayed, according to the minimal price step for this instrument. This view mode may be convenient when you need string fixed in the Order-book window, with each string presenting a particular price.

Price	Direc...	Q-ty	Summ...	Yours
115 790	Buy	36	312	
115 800	Buy	14	276	
115 810	Buy	107	262	
115 820	Buy	18	155	
115 830	Buy	26	137	
115 840	Buy	18	111	
115 850	Buy	32	93	
115 860	Buy	6	61	
115 870	Buy	21	55	
115 880				
115 890	Buy	21	34	
115 900	Buy	13	13	
115 910				
115 920	Sell	2	2	
115 930	Sell	18	20	
115 940	Sell	35	55	
115 950	Sell	42	97	41
115 960	Sell	9	106	

Fig. 6.23. Order-book window. Rarefied mode

6.2.2.2.5. Order-book window with fixed centre

For the Order-book window, you can fix its centre (the boundary between the buy and sell orders strings). To do this, use the **Save center** option in the **Window settings/ View** context menu (fig. 6.19).

B...	B...	B...	Price	S...	S...	S...
453	124		115 750			
329	163		115 760			
166	36		115 770			
130	27		115 780			
103	45		115 790			
58	26		115 800			
32	2		115 820			
30	2		115 830			
28	28		115 840			
			115 880	7	7	
			115 890	8	15	
			115 900	119	134	
			115 910	55	189	
			115 920	32	221	
			115 930	1	222	
			115 940	12	234	
			115 950	8	242	
			115 960	14	256	
			115 970	60	316	

Fig. 6.24. Order-book window. Standard mode with fixed center

Price	Di...	Q...	S...	Y...
115 690	Buy	42	244	
115 700	Buy	40	202	
115 710	Buy	28	162	
115 720	Buy	134	134	
115 730				
115 740				
115 750	Sell	4	4	
115 760				
115 770	Sell	5	9	
115 780	Sell	16	25	
115 790	Sell	6	31	5
115 800	Sell	71	102	
115 810	Sell	8	110	
115 820	Sell	11	121	
115 830	Sell	38	159	
115 840	Sell	52	211	
115 850	Sell	8	219	
115 860	Sell	21	240	
115 870	Sell	7	247	

Fig. 6.25. Order-book window. Narrow rarefied mode with fixed center

When the **Save centre** option is on, the best buy and sell prices strings are docked to the Order-book window centre. The centre position can be initially selected by using the vertical scroll-bar; after that, the window centre will be fixed against the top and bottom lines of the window and will not move away as soon as a new order will be added into the Order-book.

In the **Rarefied** mode, the Order-book window centre is indicated with two thin red lines, with the best buy price string over the top line and with the best sell price string below the bottom line. There may be some prices in between as well, not covered with any order. In this view mode, the window center can move up and down.

You can enable the Save center option also by pressing the **Shift+R** key combination.

6.2.2.3. Highlight volume

You can highlight a particular order volume by using the **Highlight volume** option in the **Window settings/ View** context menu.

Volume step:	100
Gradient step:	15
Number of steps:	5

0	0
100	100
200	200
300	300
400	400
500	500

Fig. 6.26. Order volume highlight settings

The following parameters should be specified:

- **Volume step** - the lowest level of volume and volume step (in lots); every next volume level is one step greater than the previous. Each next volume level will be highlighted. For example, volume stem is set to 100, then the levels of 100, 200, 300, etc. lots will be highlighted;
- **Gradient step** - value of highlight intensity. The greater volume of lots is, the more intensive it will be highlighted;
- **Number of steps** - number of volume levels to be highlighted. For example, if you have selected 3 steps, then only 3 levels with the previously selected volume step will be highlighted: 100, 200 and 300; if the number of steps is 5, then 100, 200, 300, 400 and 500. All volume levels greater than the maximum one will be highlighted with the maximum intensity.

The window right from the option settings group allows to preview the Order-book window before applying the settings - see fig. 6.26.

6.2.2.4. Sorting strings in the Order-book window

When the Order-book window is set in the **Standard** or in the **Narrow** view mode, you can adjust strings by price in the low to high or high to low order – see section 5.10.2. To switch between sorter orders, click the column header with the left mouse button.

Also, you can specify the sorting settings via the **Window settings/ View** context menu, by activating the **Arrange price by** option. You can change the sorting order by clicking the **Price** column header in the Order-book window.

In the Wide view mode, sorting can be done in the following ways

- strings in the columns for buy operations are sorted in one order;
- strings in the columns for sell operations are sorted in the opposite order.

Therefore, when the Order-book window is in the **Wide** view mode, the first (upper) string contains the best buy and sell prices values, then comes the second level of buy and sell prices and so on.

No other sorting order is available for the **Wide** view mode.

6.2.2.5. One-click trading setting

For your convenience, and for speeding up the process of adding orders into the trading system, there is a special **One-click trading** option available. This option can be set via the **Window settings/ Trading** context menu item.

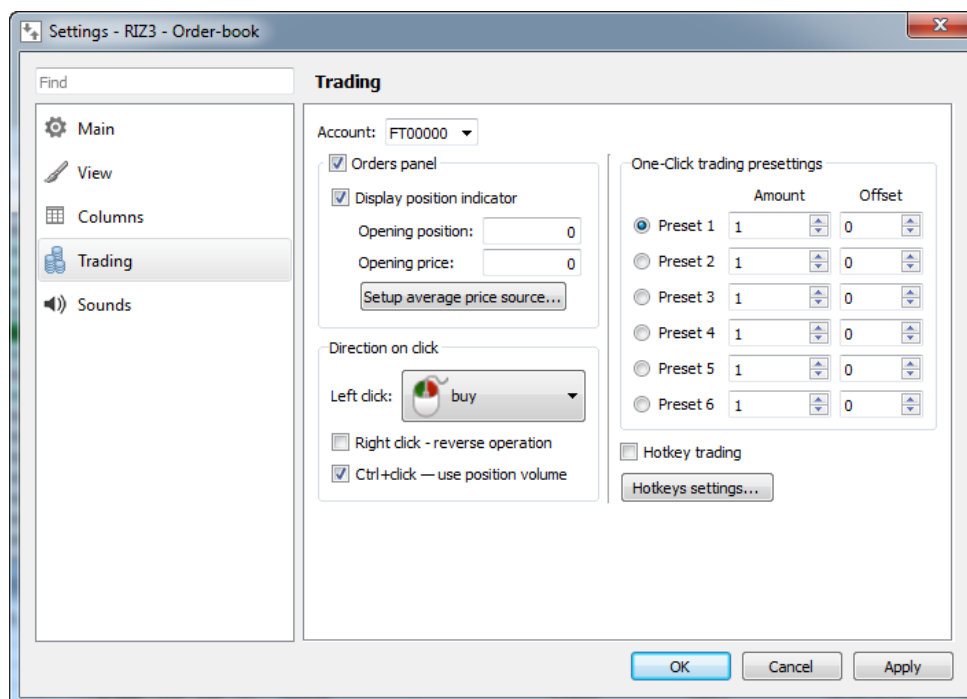

Fig. 6.27. One-click trading setting

The **One-click trading** option is specified separately for each instrument. Along with this faster way of adding order, you can continue to add order in the standard way – see section 6.2.3.

To activate the **One-click trading** option, you should select a way of adding orders into the trading system; in the **Direction on click** section, you should select the mouse button (left or right) and the Order-book window area to click to (for possible user scenarios see tab. 6.18.). Please note, that depending on the Order-book window view mode (**Standard**, **Narrow** and **Wide**), some **One-click trading** parameters may not be available for setting. The unavailable parameters in the **Left click** drop-down list (fig. 6.27) will be inactive.





The **Right click – reverse operation** option allows to assign the one-click trading function to the right mouse button for the Order-book window area opposite to the area selected for the left mouse button one-click operation; with the order direction also opposite to that assigned to the left mouse button.

After an operation has been assigned to the right mouse button, you will be able to open the context menu by clicking a column header in the Order-book window with the right mouse button.

The **Ctrl+click – use position volume** option allows to automatically set the instrument volume in order equal to that in position by holding the **Ctrl** key pressed and clicking an order in the Order-book window with the left mouse button. If the option is not enabled, then the instrument volume in order will be set equal to that specified in the One-click trading preferences settings.

Using the One-click trading mode, you should specify the account code to add orders from (the **Account** field). Please note, that the One-click trading can be performed only if the 7-digit client account code has been specified! If no client account code has been specified, the order will not be added.

Tab. 6.18. Setting the One-click trading options

Parameter	Details
Direction on click	
<input type="checkbox"/> none	The One-click trading mode is disabled.
 buy	The One-click trading mode is enabled; the left mouse button is set for adding the buy orders according to the price in the string we are clicking. If the Right click – reverse operation option is enabled, the right mouse button will be set for adding the sell orders.
 sell	The One-click trading mode is enabled; the left mouse button is set for adding the sell orders according to the price in the string we are clicking. If the Right click – reverse operation option is enabled, the right mouse button will be set for adding the buy orders.
 as in cell	The icon indicates that the One-click trading mode is enabled. The buy order will be added into the system by clicking the left mouse button onto the buy order area (green by default), and the sell order will be added upon clicking the left mouse button onto the sell order area (red by default). By clicking the left mouse button onto the blanc areas, the adding order direction (buy or sell) will depend on the one under the mouse cursor. If the Right click – reverse operation option is enabled, clicking the appropriate areas with the right mouse button will cause adding of the opposite orders.
 by string	The icon indicates that the One-click trading mode is enabled. The icon indicates that the One-click trading mode is enabled. The buy order will be added into the system by clicking the left mouse button onto the buy order area (green by default) along with the non-coloured area at the right, and the sell order will be added upon clicking the left mouse button onto the sell order area (red by default) along with the non-coloured area at the left. This option cannot be enabled for the Wide view mode. In the Rarefied mode, you will not be able to add an orders by clicking the area between the best buy and best sell prices (spread). If the Right click – reverse operation option is enabled, clicking the appropriate areas with the right mouse button will cause adding of the opposite orders.
 by column	The icon indicates that the One-click trading mode is enabled. The buy order will be added into the system by clicking the left mouse button onto the buy order area (the whole column, green by default) along with the non-coloured area above or below, and the sell order will be added upon clicking the left mouse button onto the sell order area (the whole column, red by default) along with the non-coloured area above or below.

Parameter	Details
	<p>In the Standard view mode, you will not be able to add orders by clicking a cell in the Price column.</p> <p>This mode is very convenient for trading in the Wide view mode. Please note, that it cannot be enabled in the Narrow view mode.</p> <p>If the Right click – reverse operation option is enabled, clicking the appropriate areas with the right mouse button will cause adding of the opposite orders.</p>
 from table	<p>The icon indicates that the One-click trading mode is enabled. The buy order will be added into the system by clicking the left mouse button onto the buy order area (the whole column, green by default) along with the non-coloured area above or below, and the sell order will be added upon clicking the left mouse button onto the sell order area (the whole column, red by default) along with the non-coloured area above or below.</p> <p>Contrary to the previous mode, this mode allows to add orders by clicking the Price column cells (the order direction will coincide that of the one in the cell).</p> <p>If the Right click – reverse operation option is enabled, clicking the appropriate areas with the right mouse button will cause adding of the opposite orders.</p>
One-click trading presets	
Amount	The minimum lot volume to add by the left mouse click.
Offset	The value, the newly added order will differ against the existing order in the Order-book window (in price points). The new offset value is always 'better' than the previous one. If the Offset value is '0', then the newly added order will be equal to the existed one.

In the **One-click trading presets** area, you can specify up to six preset combinations for the **One-click trading** mode.

You can switch between preset combination by selecting the one you need in the **One-click trading presets** area, or by using key combinations. To specify key combination, use the **Settings/ Terminal settings** main menu item in the **Keyboard** section- see section 10.8. The list of possible key combinations can be found in tab. 6.19.

You can work in the **One-click trading** mode also by using key combinations - see section 6.2.2.6.

6.2.2.6. One-click trading, key combinations settings

To enable the **One-click trading** with hotkeys, you should enable the **Hotkey trading** option of the **Trading** section in **Window settings** - see fig. 6.27.

There are the hotkeys specified by default, but you can select your own hotkeys if needed. You can do it in the following ways:

- by pressing the **Hotkey settings** button (see fig. 6.27 - the **Window settings context menu item/ the Trading section**);
- via the **Settings/ Terminal settings** main menu item of the **Keyboard** section - see section 10.8.

For the **One-click trading** mode, you can specify hotkeys not only for adding orders, but also for removing them from the trading, as well as for switching between One-click trading preset combinations.

The One-click trading mode preset combinations (number of lots in order and price offset) can be specified via the **Window settings** context menu item of the **Trading** section - see section 6.2.2.5. Please note, that the preset combinations are not used for all **One-click trading** mode operations; some of them demand some other scenarios. The complete list of trading operations which can be performed by using hotkeys can be found in tab. 6.19. The table describes the order parameters values obtained from the preset combination.

Using the One-click trading mode with hotkeys, you should specify the account code to add orders from (the **Account** field). If no account code has been specified, the orders will not be added.

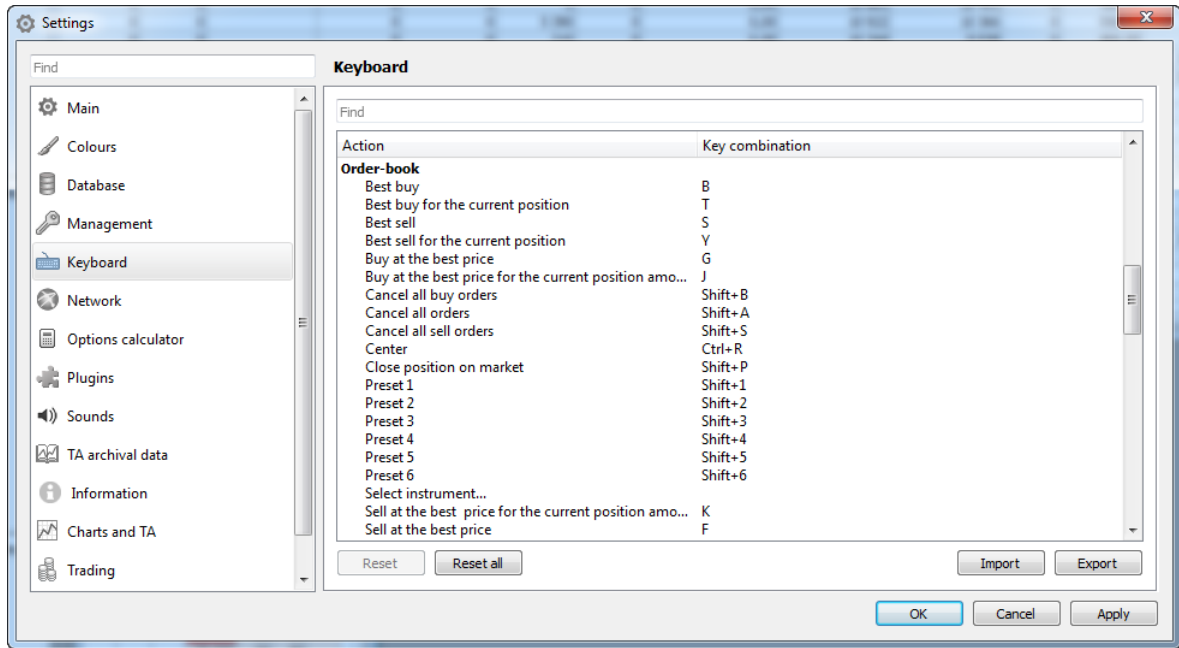

Fig. 6.28. Setting hotkeys for One-click trading mode

Tab. 6.19. List of hotkeys for the One-click trading mode

Command	Hot keys	Details
Close position on market	Shift+P	<p>If you currently have a position for an instrument, the sell order will be added with the maximum instrument amount available on user's account. The order price is equal to that of the best buy order.</p> <p>If you currently have a position for an instrument, the buy order will be added with the maximum instrument amount available on user's account. The order price is equal to that of the best sell order.</p> <p>Please note, that preset combinations are not available for this operation.</p>
Buy at the best price	G	<p>Adds a buy order at the best sell price, with the instrument volume specified in the active preset combination.</p> <p>Please note, that only the Amount parameter of the selected preset combination will be used!</p>
Buy at the best price for the current position amount	J	<p>Adds a buy order at the best sell price, with the instrument volume specified in the active preset combination.</p> <p>Please note, that only the Amount parameter of the selected preset combination will be used!</p>
Best buy	B	<p>Adds a buy order at the best buy price, according to the price offset value specified in the active preset combination.</p>

Command	Hot keys	Details
		Please note, that the both Amount and Offset parameters of the selected preset combination will be used!
Best buy for the current position	T	Adds a buy order at the best buy price, with the price offset value specified in the active preset combination, for the whole instrument volume available on the account. Please note, that only the Offset parameter of the selected preset combination will be used!
Best sell	S	Adds a sell order at the best sell price, according to the price offset value specified in the active preset combination. Please note, that the both Amount and Offset parameters of the selected preset combination will be used!
Best sell for the current position	Y	Adds a sell order at the best sell price, with the price offset value specified in the active preset combination, for the whole instrument volume available on the account. Please note, that only the Offset parameter of the selected preset combination will be used!
Preset 1	Shift+1	Enables the preset combination #1 from the presets list.
Preset 2	Shift+2	Enables the preset combination #2 from the presets list.
Preset 3	Shift+3	Enables the preset combination #3 from the presets list.
Preset 4	Shift+4	Enables the preset combination #4 from the presets list.
Preset 5	Shift+5	Enables the preset combination #5 from the presets list.
Preset 6	Shift+6	Enables the preset combination #6 from the presets list.
Sell at the best price	F	Adds a sell order at the best buy price, with the instrument volume specified in the active preset combination. Please note, that only the Amount parameter of the selected preset combination will be used!
Sell at the best price for the current position amount	K	Adds a sell order at the best buy price, with the instrument volume specified in the active preset combination. Please note, that only the Amount parameter of the selected preset combination will be used!

Command	Hot keys	Details
Cancel all orders	Shift+A	Cancel all user's active orders. For more information about order cancellation (considering user's status and account code) see section 6.2.11.
Cancel all buy orders	Shift+B	Cancel all user's active buy orders. For more information about order cancellation (considering user's status and account code) see section 6.2.11.
Cancel all sell orders	Shift+S	Cancel all user's active sell orders. For more information about order cancellation (considering user's status and account code) see section 6.2.11.

You can specify up to six preset combinations for the **One-click trading** mode in the **One-click trading presets** section (see fig. 6.27). To elect a preset combination, click the button next to the preset combination name.

You can select a preset combination either from the **One-click trading presets** section, or by using hotkeys. To specify hotkeys combination, use the **Settings/ Terminal settings** main menu item, the **Keyboard** section - see section 10.8. The complete list of possible hotkeys combinations can be found in tab. 6.19.

6.2.2.7. Orders panel

In the Order-book window, you can set up a special panel to view your active orders for the current instrument.

B...	B...	B...	Price	S...	S...	S...	
							115 380
							115 510
							115 530
							115 550
							115 610
							115 660
							184 952
							758
							115 446
							[1/0]
							115 790
							115 810
							115 820
							115 950
							115 960
							115 980

Fig. 6.29. Orders panel

The  button on the local instrument panel of the Order-book window allows to hide/show the Order-book panel.

The settings can be made via the **Window settings/ Trading** context menu item, the **Orders panel** option - see fig. 6.27. In the image below, you will see the orders panel settings section of the **Trading** window fig. 6.30 :

Fig. 6.30. Orders panel settings

The Orders panel is situated in the right side of the screen; it displays the user's active orders, where buy orders are highlighted in green and sell orders are highlighted in red. The orders are grouped by price, i. e., if there were several orders added with the same price, they all will be placed in the same record. Every record in the Orders panel contains the order price value.

Please note, that the Orders panel should be set separately for each instrument.

In the Wide view mode, the Orders panel consists of two columns, where orders are sorted from up to down (the best price is in the upper string).

If you represent a brokerage firm and, due to this, have several accounts, your orders in the **Order panel** can be sorted by particular account. To do this, use the **Account** field in the **Window settings/ Trading** context menu - see fig. 6.30. After an account has been selected, the Orders panel will contain only the orders added from that account. To display all orders from all accounts, you should clear the **Account** field. This option allows to open more than one Order-book windows for the same instrument at once, but with orders added from different client accounts.

When the **Orders panel** is active, you can activate the position indicator via the **Display position indicator** option - see section 6.2.2.7.1.

The **Order** panel is also allows to remove orders from trading by the following methods:

- by clicking the left mouse button on a string in the **Order** panel. All orders with the selected price will be removed;
- via the **Cancel orders** context menu item, opened from any part of the window. This option allows to select orders for removing:
 - **Cancel all orders - Shift+A** - removes all user's orders for the selected instrument;
 - **Cancel all buy orders - Shift+B** - removes all user's buy orders for the selected instrument;
 - **Cancel all sell orders - Shift+S** - removes all user's sell orders for the selected instrument;

6.2.2.7.1. Position indicator

In the Order-book window, in the **Order** panel, you can enable the position indicator via the **Window settings/ Trading** context menu item with the **Display position indicator** option. Please note, that the position indicator option is available only after specifying a user's account in the **Account** field (see fig. 6.30). The position indicator will be displayed in the centre of the **Order** panel:

```

-1 260
-7
148 990
[1/0]

```

Fig. 6.31. Position indicator

The position indicator displays the following information:

- unrealized gain or loss - the gain/loss you will obtain after closing the current position for instrument (including the opening position) for the current market position. A positive value indicates gain, while a negative one indicates loss. The value units are equal to that in the Order-book window (for example, points). The loss value is highlighted in red;
- the current position for the account (including the opening position);
- position average price;
- amount of instrument in order (for the **One-click trading** mode) – the value before slash. The value is obtained from the the active preset combination (section 6.2.2.5). The default value is '1';
- price offset for the **One-click trading** mode – the value after slash. The value is omitted from the the active preset combination (section 6.2.2.5). The default value is '0';

If you have selected a BF or CF account code, then the position indicator values for the whole BF or CF will be displayed. If you have not selected any account code, then the position indicator will not be displayed at all, even when installed option **Display position indicator**.

There are some additional parameters for the position indicator to set:

- **opening position** - see section 6.2.2.7.2;
- **opening price** - see section 6.2.2.7.3.

6.2.2.7.2. Setting the opening position

For the Order-book window, you can specify the opening position via the **Window settings/ Trading** context menu item, the **Opening position** field (see fig. 6.30). The default opening position value is '0'.

The opening position means the frozen amount of instrument, which is not included into the current position and, therefore, cannot be used. The opening position is not included into the unrealized gains or losses value.

For example, if there is a volume of 100 units of instrument on the account, with the opening position set to '20' , then the current position volume will be '80'.

For using the opening position option, you should specify an account code first. If you have specified a CF or BF account code, then the opening position settings will be applied to every CF or BF account.

6.2.2.7.3. Setting the opening price

For the Order-book window, you can specify the average opening price for accumulated positions via the **Window settings/ Trading** context menu item, the **Opening price** field (see fig. 6.30).

To enable the option, you should press the **Average price source** button. For more information see section 10.16.

If either **Import from 'Positions' table** or **Equal to the previous session settlement price** option is enabled in the global settings section (section 10.16), then the value set in the **Opening price** field will be ignored; the position indicator value will be obtained from the **Positions/ requests** table or set equal to the settlement price of the previous trading session.

In order to use the value specified in the **Opening price** field, the **Set manually in the 'Order-book' window** option should be enabled in the global settings section.

6.2.2.8. Setting sound notification

In the **Order-book** window, you can specify a sound warning at adding new order and matching trade for the instrument from the Order-book window.

To do this, use the **Window settings** context menu item of the **Sounds** section.

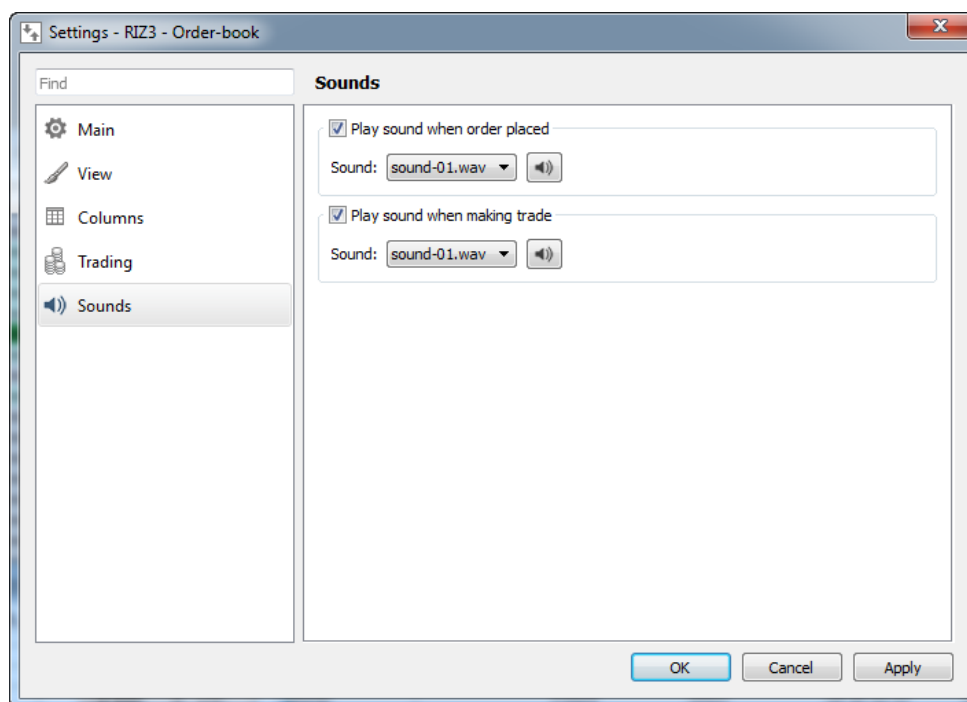

Fig. 6.32. Setting a sound warning at adding orders and matching trades

If the **Play sound when order placed** option is enabled, then every time a new order is added into the system, a selected sound will play. The option remains enabled, until you close the Order-book window.

If the **Play sound when matching trade** is enabled, every time a new trade is matched, a selected sound will play.

You can select a sound signal from the **Sound** field among the ones in the drop-down list. Every signal can be previewed; to preview a sound signal, select it in the drop-down list of the **Sound** field and press the appropriate button right to the **Sound** drop-down list .

By default, the sound warning option is disabled; therefore, you should set it separately for each opened window.

6.2.2.9. Context menu in the Order-book window

For information about the standard commands of the context menu - see Chapter 11. Below are the special **Order-book** window commands:

- **Add order by price** – opens the order adding window (see section 6.2.3.1). The price value in the appropriate field is obtained from the one under the mouse cursor;
- **Open chart** – creates a graphical chart in the new **Tech. analysis** window;
- **Information** - opens the **Information** window for the current instrument;
- **Change instrument(s)** – allows to select a new instrument in the Order-book window. The **Select instrument** window appears on the screen (see section 5.11.1), where you should select the instrument you need and press **OK**. If there are several instruments with different exercising dates for one underlying asset (for futures and calendar spreads), then they will be additionally displayed in the context menu;
- **Center** – returns the Order-book geometrical center in the center of the **Order-book** window;
- **Cancel orders** - allows to remove more than one order at once:
 - **Cancel all orders** - removes all your orders for the current instrument;
 - **Cancel all buy orders** - removes all your buy orders for the current instrument;

- **Cancel all sell orders** - removes all your sell orders for the current instrument.

The order cancellation result strictly depends on the user status (client, CF, BF), for more information see section 6.2.11.

6.2.3. Adding orders into the trading system

You can add order into the trading system by one of the following ways:

- via the **Trading/ Add order** main menu item or by instrument panel button . The order adding window will appear on the screen (see section 6.2.3.1), with the following fields: **Floor**, **Board** and **Instrument** filled with the values from the last call of the order adding window. The fields may be empty though, if they were not filled in during the previous session.
- from the **Order-book** window, via the **Add order at price** context menu. The order adding field window will appear on the screen (see section 6.2.3.1), with some fields filled in with parameters of the order under the cursor;
- from the **Financial instruments** window, via the **Add order at** context menu item – the instrument code is equal to that of the order under the cursor. The order adding window will appear on the screen (see section 6.2.3.1), with the following fields filled in: **Floor**, **Board** and **Instrument**. The **Account**, **Price** and **Quantity** fields are empty, and should be filled in by you;
- from the **Your orders/ requests** window, via the **Add order** context menu item – the standard order adding window will appear on the screen (see section 6.2.3.1), with the fields filled in with parameters of the order under the mouse cursor;
- by double-clicking a string in the **Your orders/ requests** or **Order-book** windows;
- by clicking an order in the **Order-book** window either with the left or right mouse button, if the **One-click trading** mode has been enabled for the instrument (see section 6.2.2.5);
- by pressing a key combination - the complete list of the available key combinations can be found in the **Settings/ Terminal settings** menu item, in the **Keyboard** section - see section 6.2.2.6;
- via the **Repeat order** context menu item of the side panel, in the **Unprocessed orders** section. The standard order adding window will appear on the screen, with the fields filled in with parameters of the selected order. You can either edit the parameters before adding the order or left them unchanged;
- via the **Add order** context menu item of the side panel, from the **Favorite instruments** section;
- via the **Add order** context menu item of the **Options board** window;
- via the **Trading/ Postponed orders** main menu item, where you can add a batch of orders - see. section 6.2.8.

6.2.3.1. Adding order window

The standard adding order window can be opened via the **Trading/ Add order** main menu item or via the **Add order** context menu item, opened from the following windows:

- **Financial instruments**;
- **Order-book**;
- **Your orders/ requests**;
- **Options board**.

When you open the order adding window from the main menu or from **Postponed orders** window, its fields **Floor**, **Board** and **Instrument** will be filled with the values from the last call the order adding window. Please note, that after you filled in the **Board** field, some extra fields will appear in the window according to the trading board selected.

When you open the order adding window from the context menu, its fields will be filled in with parameters of the order under the mouse cursor. Before adding the order into the trading system, you can either edit the parameters in the fields or remain them unchanged.

Below you can see the order adding window:

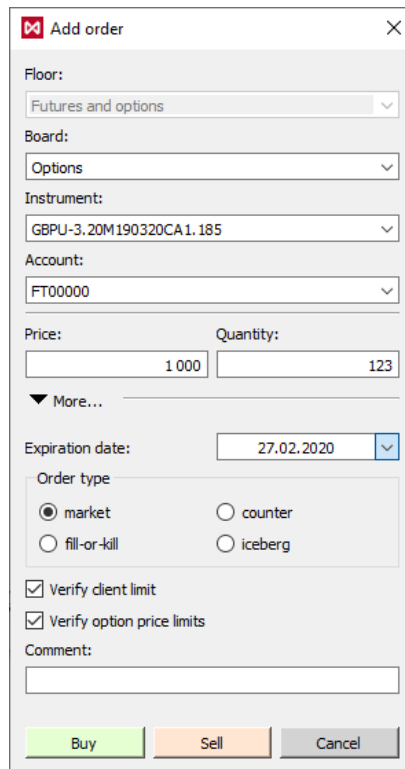

The screenshot shows the 'Add order' window in 'Order adding mode'. The window has a title bar with a red 'X' icon and a close button. The fields are filled with data: Floor: 'Futures and options', Board: 'Options', Instrument: 'GBPU-3.20M190320CA1.185', and Account: 'FT00000'. The Price field contains '1 000' and the Quantity field contains '123'. A 'More...' dropdown is expanded, showing 'Expiration date: 27.02.2020'. Under 'Order type', 'market' is selected with a radio button. There are also radio buttons for 'counter', 'fill-or-kill', and 'iceberg'. Two checkboxes are checked: 'Verify client limit' and 'Verify option price limits'. A 'Comment:' field is empty. At the bottom, there are three buttons: 'Buy' (green), 'Sell' (orange), and 'Cancel' (grey).

Fig. 6.33. Adding order. Order adding mode

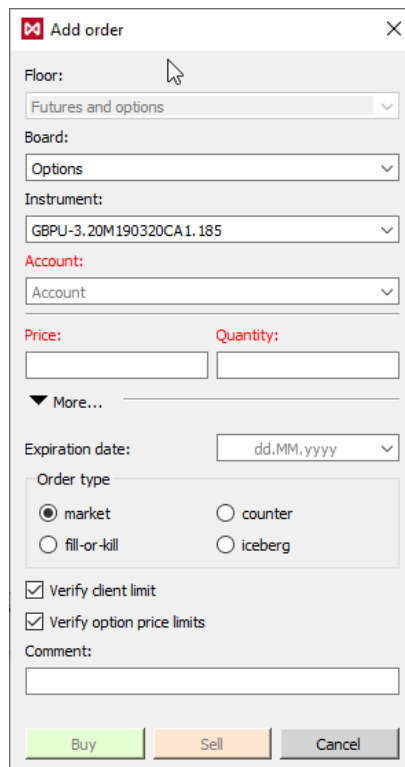

The screenshot shows the 'Add order' window in 'Editing mode'. The window has a title bar with a red 'X' icon and a close button. The fields are empty: Floor: 'Futures and options', Board: 'Options', Instrument: 'GBPU-3.20M190320CA1.185', and Account: 'Account'. The Price and Quantity fields are empty. A 'More...' dropdown is expanded, showing 'Expiration date: dd.MM.yyyy'. Under 'Order type', 'market' is selected with a radio button. There are also radio buttons for 'counter', 'fill-or-kill', and 'iceberg'. Two checkboxes are checked: 'Verify client limit' and 'Verify option price limits'. A 'Comment:' field is empty. At the bottom, there are three buttons: 'Buy' (green), 'Sell' (orange), and 'Cancel' (grey). A mouse cursor is visible over the 'Floor:' dropdown menu.

Fig. 6.34. Adding order. Editing mode

The buy and sell orders are added from the same window buy using either **Buy** or **Sell** button.

Button **More** allows to display/hide non-mandatory fields.

Press **Cancel** to close the window without adding order.

When the order adding window opens, all its fields are blank, and the field names remain red until you fill it in properly (after that, all field names colour changes to black). Until you fill in all the necessary fields, the **Buy** and **Sell** buttons will be unavailable.

When filling in the window fields, a context help lines appear, containing the most suitable values for this field. To use a proper variant, press it with the left mouse button.

Quote input form for RFS streams has a different set of parameters - see section 6.6.4.

Tab. 6.20. Parameters in the Add order window

Parameter	Details
Floor	Floor short name. You can select a proper value from the drop-down list or enter manually using keyboard.
Board	Instrument board. You can select a proper value from the drop-down list or enter manually using keyboard. The drop-down list contains only the boards for the selected floor. The field combination strictly depends on the selected board, i. e. there may some additional fields appear after selecting a particular board.
Instrument	Instrument short code. You can select a proper value from the drop-down list or enter manually using keyboard. The drop-down list contains only the instruments for the selected board. If no board has been specified, the list will be empty. If you are adding an anonymous or negotiated order, the drop-down list will then contain only the instruments with the anonymous or negotiated trade flags.
Account	Client account code. Can be selected from the drop-down list.
Price	Instrument unit price. The price value will be automatically divided into three-digit groups. For the order for option, the contract premium value must be entered in this field instead of instrument unit price.
Quantity	Number of the instrument in the order. Quantity of instruments should be a multiple of the minimum lot of the instrument.
Yield	Yield on futures on interest rates. This field becomes available only for certain instruments. The Price field value will be recalculated in accordance with the value of the Yield field, and vice versa.
Mandatory settings (to display the settings, click More)	
Expiration date	Order expiration date (dd/mm/yyyy). The available data range: no later than today, not earlier than 1 year after the current date. The field is not applicable for IQS. If this field is not filled, the adding order will be standard (day order). If you entered an expiration date, the order will be automatically relisted for a new trading session with a new number and new expiration time (multi-day order). Orders with expired dates will be automatically removed at the end of the evening session. The date can be set via the calendar in the right side of the field.

Parameter	Details
	When orders are being relisted, the system automatically verifies the amount of instrument, client details and funds to meet the order requirements.
Order type	Order type: <ul style="list-style-type: none"> • market – adds the standard order; • counter – before adding the order, the system checks if there is a counter order already in the trading system. If yes, the order will be added into the system and matches immediately. If no, the order will not be added. Unlike the quoted order which remains in the system after being partly matched, the rest of the counter order will be removed; • fill-or-kill – order must be executed immediately and completely or not at all. This order type is not allowed to IQS; • iceberg - iceberg order (details see section 6.2.4)
Verify client limit	When the option is enabled (by default), the order will be verified for client limit sufficiency before being added into the system. If the option is disabled, no verification will be made for the order. Please note, that adding of orders without preliminary verification is allowed only for BF granted with the special rights by the administrator. The setting is not available in the IQS entry form.
Verify option price limits	The setting is available only within the option order entry-form. The setting is not available in the IQS entry form. When the option is enabled (by default), the order will be verified for limits sufficiency before being added into the system. If the option is disabled, no verification will be made for the order. Please note, that adding of orders without preliminary verification is allowed only for BF granted with the special rights by the administrator.
Comment	Order additional details. This field is used for adding a brief (up to 20 symbols) comments with some additional information regarding the order. The comment will be added into the system along with the order and then transferred into the trade after successful matching.
Buttons	
Buy	Adds the buy order.
Sell	Adds the sell order.
Cancel	Closes the order adding window without adding any order into the system.

After pressing the **Buy** or **Sell** button, a confirmation message *"Are you sure you want to place order for buying with price...of ...contracts from account...?"* appears on the screen. Press **Yes** to add the order into the trading systems, or no **No** to cancel – the order adding window then remains open.

You can check the **Do not show next time** checkbox to disable the confirmation message.

You can specify the order adding confirmation message settings via the **Order adding confirmation** option in the **Settings/ Terminal settings** window, the **Main** section, **Confirmations** tab.

If your order has been rejected by the trading system, you will receive a error message, and your order will be removed into the **Unprocessed orders** section of the side panel. The **Messages** window contains all messages sent by the trading system in reply to adding orders.

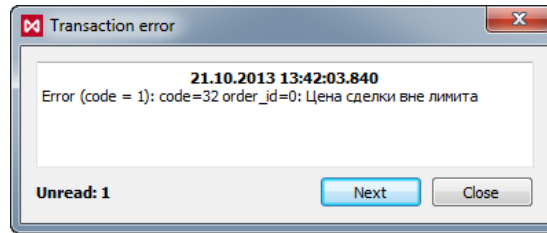

Fig. 6.35. Order adding error message

6.2.4. Iceberg orders

An Iceberg order is a variation of a quote order. It allows you to hide a part of its volume from the market (that is, in the Order-book window) to minimize the impact on the large orders market price. Iceberg orders appear in the order-book in portions. The next portion "pops up" only after the visible part of the order will be executed. The pop-up part sets at the end of the same price level list of order. This process can be repeated until the whole hidden part is used.

All types of logins can set an iceberg orders. Iceberg orders can be placed on all instruments in an anonymous mode (futures, options, spread).

Collateral is blocked for the full volume of the iceberg, not for the visible part only.

You can set the order lifetime for this type of order. So orders are re-set during the evening clearing without any limits on the disclose part.

When an iceberg order is deleted or changed, both the visible and invisible parts are deleted or changed.

The window for add an iceberg order has the following form:

Fig. 6.36. Add iceberg order

For the entry fields description please refer to tab. 6.20. All procedure of submitting the iceberg order is similar to that of adding a new standard order (see section 6.2.3.1).

Additional fields for iceberg are displayed when you select the **Order type** 'iceberg' only. To select the order type, you have to open the input form fully by clicking on the **More** button.

Additional parameters for iceberg:

- **Disclose** - volume of the constant disclose part. It is a required parameter for an iceberg. It may be indicated in contracts or as a percentage of the order total volume. A disclose volume cannot be less than the minimum lot for this instrument and can be only integer positive values. When a percentage value is specified, it is recalculated into contracts and rounded to the nearest whole to a lower value;
- **Variance** - variance amplitude for a random addition for the disclose part. It is an optional parameter for an iceberg. It may be indicated in contracts or in percent. Default value - 0%.

The addition value is a random variable with a uniform distribution from the range

$[-\text{Round}(\text{DiscloseConstAmount} * \text{VarianceAmount\%/100}, 0); \text{Round}(\text{DiscloseConstAmount} * \text{VarianceAmount\%/100}, 0)]$, where

DiscloseConstAmount - volume of the constant popup part;

VarianceAmount% - variance amplitude for a random addition in percent.

6.2.5. Request to NCC

Requests to National Clearing Centre are proposed to be submitted in order to settle a Trading Participant's obligations against a Clearing Participant, eg. in case of the Trading Participant's insufficient amount of collateral. To submit a request to NCC, please use the main menu item **Trading/ Request to NCC**).

Please note that requests to NCC may not be submitted by a Clearing Participant which is not simultaneously a Trading Participant. Instead, a Clearing Participant is able to submit requests to NCC for performing trades with Trading Participant.

You can submit your request to NCC using the window shown below:

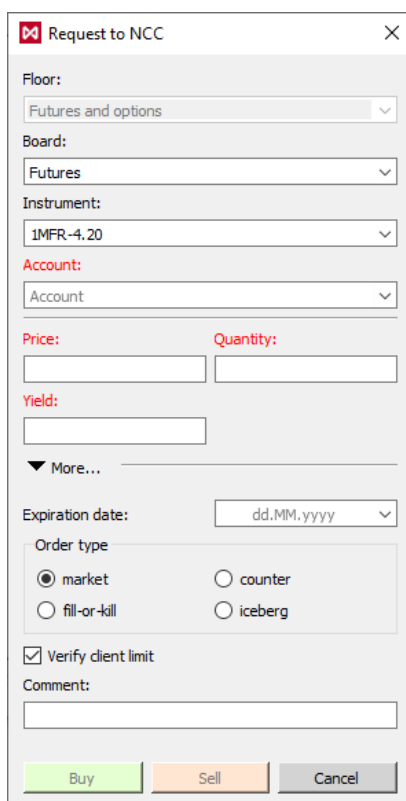

Fig. 6.37. Request to NCC

For the entry fields description please refer to tab. 6.20. All procedure of submitting the request to NCC is similar to that of adding a new order, with a single exception of parameter **Floor**, which is always set to **Futures and Options** in case of requests to NCC, and cannot be changed.

A Clearing Participant can submit their request to NCC specifying any available Trading Participant's account. Before submitting the request, please make sure to unselect the **Verify client limit** check box.

The submitted requests will obtain the special flag **Request to NCC** shown in the tab at **Your orders/ requests**. All trades performed basing on these requests (shown in the tab at **Your trades/ requests**) will be also marked with the same flag.

All requests to NCC should be submitted in accordance with the effective trading time schedule.

A Clearing Participant, which is simultaneously a Trading Participant, is not eligible to submit requests to NCC (as clearing participants are able to add orders in the Trading system directly by themselves).

A Trading Participant is not eligible to cancel requests to NCC for performing trades which had been submitted by a Clearing Participant. It is only the Clearing Participant who is able to cancel their requests to NCC via the window **Own orders**, context menu item **Cancel**, or by double-clicking an order with left mouse button in orders tab of the order-book window.

6.2.6. Indicative quotes

Indicative Quote System (IQS) is a service provided by Moscow Exchange, which allows trade participants to view and take actions with indicative quotes on the Derivatives Market instruments. An Indicative quote here stands for the buy (or sell) price indicating a trade participant's intention to perform a trade, without any obligation to do that (which means that no collateral will be pledged to cover the trades). Therefore, a trade participant is able to indicate their trading interest in a wide range of instruments, without having any financial expenses.

Indicative quotes can be added on all types of the instruments traded on the Derivatives Market, in accordance with the rights granted by the trading administrator. The following instrument types are supported:

- Futures;
- Options;
- Multi-leg instruments (calendar spreads).

There is a special Trading floor called **Ind. quotes**, along with the special trading boards, i.e.: **Futures (IQS)**, **Options (IQS)**, **Spread (IQS)**.

Indicative quotes can be added on all types of the trading instruments, in accordance with the rights granted by the trading administrator. Once a login has rights to add orders into the trading system on behalf of a 7-digit section, it is also having rights to add indicative quotes into IQS.

To start working with indicative quotes, you should specify the following settings:

- in section **Transport** (main menu item **Settings/ Terminal settings**), check the checkbox **Indicative quotes** in area **Floors** - see section 10.17;
- in section **Transport** (main menu item **Settings/ Terminal settings**), in area **Profiles** specify a server address and a port number in section **Indicative quotes** - see section 10.17;

To make indicative quotes data visible within the window, you should switch to the indicative quotes mode by pressing the button **IQ**, which is available only for instruments allowed for IQS, and notice the window header now containing the line **Ind. quotes**. To switch the window back to the standard mode, simply click the button again.

Buy:yours	Buy:qty	Price	Sell:qty	Sell:yours
	10	104		
		105	5	

Fig. 6.38. Order-book. Indicative Quote mode

The way of working with indicative quotes is quite similar with that of standard orders (see section 6.2.2).

When adding quotes on futures and calendar spreads, the given price is verified to match the price fluctuation limits.

Please note, that quotes are allowed to be added only during active trading sessions, in accordance with the trading schedule.

Please also note that it is prohibited to perform indicative trades between the same client accounts, or client accounts with the same ISIN, when the cross-trade verification is enabled for at least one account.

6.2.7. Synthetic orders. Synthetic matching

In synthetic matching, three orders for different trading instruments can be matched to a trade if the prices of these instruments are linked by a certain ratio. Synthetic matching is not possible for negotiated orders. A synthetic order is formed as a result of synthetic matching.

For orders participating in synthetic matching, the following condition must be fulfilled: the sum of the orders prices multiplied by '+1' for the buy order and by '-1' for the sell order should not be negative.

Synthetic matching happens simultaneously with standard matching. This means that the buy order of a calendar spread from the example considered below can be matched with both a sell order on the same calendar spread (standard matching), and with two orders for futures-legs (synthetic matching). Matching priority is this: at the best price, and at the order application time of within the framework of one price level. The synthetic order registration time is the largest of the times of real orders, on the basis of which the synthetic order is generated.

Calendar spread is an instrument of the Derivatives market, which allows to simultaneously execute oppositely directed transactions (sell and buy) with two futures of different exercise dates on one underlying asset (the "legs" of the calendar spread). The calendar spread price is the difference between the far leg price and the near leg price. A calendar spread can be created by the exchange for any underlying asset. Participants cannot create calendar spreads.

When adding a new calendar spread, a group of synthetic matching is automatically created. The group includes the calendar spread itself and the leg-instruments of this calendar spread. When the calendar spread expires, the synthetic matching group is automatically deleted.

A synthetic order is generated on behalf of NCC (from a dedicated client account assigned to NCC) and is a real order added by the central counterparty to the trading system. The synthetic order volume is equal to the minimum volume of all orders participating in synthetic matching. Synthetic order appears in trades generated during synthetic matching. The synthetic matching trade price is equal to the passive order price.

For each instrument, the condition is true that the best buy order price is less than the best sell order price, taking into account synthetic orders. Regardless of the order type (synthetic or real), the active order is matched to the passive one, which has the best price. If the passive synthetic and passive real orders have the same price level, then first the active order is matched to the one received earlier.

Note

Example

There are some orders, which can be executed simultaneously:

- buy order for calendar spread RTS-9.18-12.18 at a price 1000 - participant A
- buy order for futures RTS-9.18 at a price 114000 - participant B
- sell order for futures RTS-12.18 at a price 115000 - participant C

In this case:

- participant B will get a long futures position RTS-9.18 at a price 114000
- participant C will get a short futures position RTS-12.18 at a price 115000
- participant A will get two positions:
 - a short futures position RTS-9.18 at a price 114000
 - a long futures position RTS-12.18 at a price 115000

at what their prices are related by the ratio $115000 - 114000 = 1000$

On the Moscow Exchange, trades are performed with a central counterparty (NCC). In this example, three trades will be performed:

- for calendar spread RTS-9.18-12.18 between participant A and NCC
- for futures RTS-9.18 between participant B and NCC

- for futures RTS-12.18 between participant C and NCC

To correctly reflect information on synthetic matching trades in the system information streams (two orders must be indicated for each trade), synthetic orders will be created and registered on behalf of NCC in the core during synthetic matching. In this example, the following synthetic orders are generated on behalf of NCC:

- sell order for calendar spread RTS-9.18-12.18 at a price 1000 (opposite order to participant A order)
- sell order for futures RTS-9.18 at a price 114000 (opposite order to participant B order)
- buy order for futures RTS-12.18 at a price 115000 (opposite order to participant C order)

6.2.8. Postponed orders (batch entry)

The trading terminal application allows you to add batch of orders. Before adding, these orders should be selected into a special list of so called postponed orders. After selection has been made, the batch of the postponed orders can be sent into the trading system.

You can work with postponed orders via a particular window, which can be opened via the main menu item **Trading/Postponed orders**:

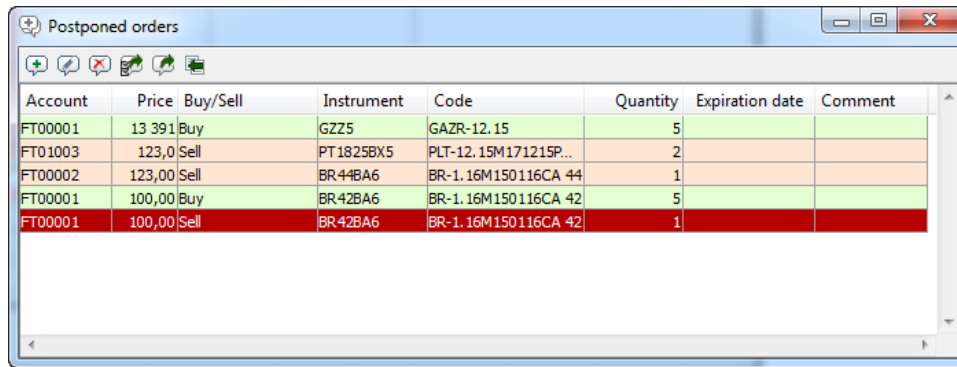

Account	Price	Buy/Sell	Instrument	Code	Quantity	Expiration date	Comment
FT00001	13 391	Buy	GZZ5	GAZR-12.15	5		
FT01003	123,0	Sell	PT1825BX5	PLT-12.15M171215P..	2		
FT00002	123,00	Sell	BR44BA6	BR-1.16M150116CA 44	1		
FT00001	100,00	Buy	BR42BA6	BR-1.16M150116CA 42	5		
FT00001	100,00	Sell	BR42BA6	BR-1.16M150116CA 42	1		

Fig. 6.39. Postponed orders

Tab. 6.21. Parameters of the Postponed orders window

Parameter	Details
Floor	Floor short name/ This feature is not supported for ASTS and ETS floors. The field is not mandatory when importing data into the postponed orders window. The default value is SPECTRA.
Board	Instrument board. The field is not mandatory when importing data into the postponed orders window. The default board is set as anonymous. If an order contains any value in field Counterparty , then the board will be set as is negotiated.
Account	Client code
Price	Order price
Buy/ Sell	Order type
Counterparty	Brokerage Firm code of the request recipient. The field is not mandatory when importing data into the postponed orders window.

Parameter	Details
	If this field contains any value other than null, then the order will be identified as negotiated.
Instrument	Instrument short code
Code	Instrument code
Quantity	Quantity of the instrument in the order
Expiration date	Order expiration date
Comment	Additional info

As the window is not bound to any particular instrument or client account, it is possible to add orders for any instruments or client accounts into the postponed orders list.

The following actions can be performed to the postponed orders:

- add an order into the postponed orders list - see section 6.2.8.2;
- edit an order in the postponed orders list - see section 6.2.8.2;
- remove one or several orders from the postponed orders list - see section 6.2.8.3;
- send the batch of orders into the Trading system - see section 6.2.8.4.

You can perform actions to postponed orders either via the local instrument panel buttons or context menu commands (see section 6.2.8.1).

Before deleting orders, you can select a batch of orders in the list to delete. The window accepts all the standard key combinations with using **Ctrl** and **Shift** for selecting more than one record.

When you double-click the left mouse button on an order in the list, a standard order edit form will appear on the screen, containing data of the selected order.



The order list can be sorted by any column. Sorting is done by double-clicking the left mouse button on the column header. Repeat the action changes to the opposite order.



The postponed order list remains visible in the window until the window is closed (or you can save the list as a part of the workspace configuration to make it visible every time you open the window - see section 5.7.2).

You can open more than one window with postponed orders at once.

6.2.8.1. Toolbar of the Postponed orders window

Tab. 6.22. Toolbar of the Postponed orders window

Icon	Context menu command	Details
	Add	Adds order into the list of postponed orders. Opens the order adding form - for details see section 6.2.8.2.
	Edit	Opens the order editing form already filled in with parameters of the selected order. This command is set as the default command and can be executed by double-clicking the order in the list with the left mouse button. After editing an order, it will replace the initial order in the postponed orders list. - see section 6.2.8.2.
	Remove order	Removes selected orders from the postponed orders list - see section 6.2.8.3.

Icon	Context menu command	Details
	Send selected orders	Sends selected postponed orders into the Trading system - see section 6.2.8.4.
	Send all	Sends all postponed orders into the Trading system - see section 6.2.8.4.
	Import	Load data from text csv-file into postponed orders window - see section 6.2.8.5, deleting all data stored in it.

Description of the standard context menu commands - see Chapter 11.

6.2.8.2. Adding orders into the list and editing them

You can add a new order into the list by two methods:

- by pressing the appropriate button in the local instrument panel ;
- via the context menu item **Add order**.

Adding orders into the list will be processed via the standard order adding form - see section 6.2.3.1.

The order adding form may open empty if the list of postponed orders contains no orders, or the mouse cursor is not placed over an order (if there is any in the list), or if you open the order adding form for the first time per the current session. In all other cases, the fields **Floor**, **Board** and **Instrument** will be filled in with values entered during the last session.

If there is an order selected in the list, than the order adding form will be filled in with the details of the selected order (the one under the mouse cursor); you can edit the details in the form before adding the order into the list of postponed orders by pressing either **Buy** or **Sell** button.

Please note, that when you add an order into the list of postponed orders, this order IS NOT added into the Trading system.

When you add an order into the list of postponed orders, there can be a possibility when the list already contains an order with the same direction, account and price values (see fig. 6.40). In this case, a window will appear on the screen, containing the possible order adding scenarios:

- **Cancel** - the new order will not be added;
- **Merge** - the new order and the already existing orders will be merged into one, and their amounts of instruments will be merged as well;
- **Replace** - the amount of instruments in the new order will replace that of the already existing order.

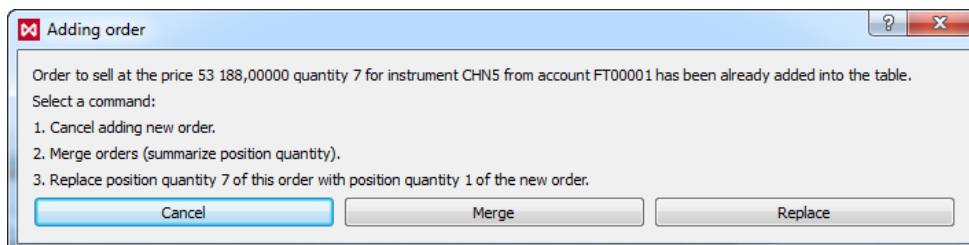



Fig. 6.40. Order adding scenarios window

You can enable the order editing mode by two methods:

- by double-clicking an order in the list of postponed orders;

- by pressing the appropriate button in the local instrument panel ;
- via the context menu item **Edit order**.

After that, the order adding form appears on the screen in the editing mode. After editing, you should add the order into the list of postponed orders by pressing either **Buy** or **Sell** button. The newly added order will replace the already existing order.

6.2.8.3. Removing postponed orders

You can remove one or several orders from the list of the postponed orders by the following methods:



- by pressing the appropriate button in the local instrument panel ;
- via the context menu item **Remove order**.

Before removing orders, you can select a batch of orders in the list to remove. The window accepts all the standard key combinations with using **Ctrl** and **Shift** for selecting more than one item, as well as the combination **Ctrl+A** for selecting all orders at once.

The option **Postponed orders cancellation confirmation** allows to set confirmation on removing orders from the postponed orders list. If the option is enabled, you will receive a warning message *Are you sure you want to cancel ... orders?* every time you try to remove orders from the list. To confirm removing press **Yes**, to cancel press **No**. If the option is disabled, the selected orders will be immediately removed from the list. You can disable the confirmation option right in the warning confirmation window by setting **Do not show next time**.

6.2.8.4. Sending postponed orders into the Trading system

All orders or selected orders in the postponed orders list can be sent into the Trading system simultaneously:

- by pressing the appropriate button in the local instrument panel  - **Send all**;
- by pressing the appropriate button in the local instrument panel  - **Send selected orders**.

The option **Postponed orders sending confirmation** in the tab **Confirmations (Settings/ Terminal settings/ Main)** allows to set confirmation on sending orders into the Trading system. If the option is enabled, you will receive a warning message *Are you sure you want to send ... orders?* every time you try to send orders. To confirm sending press **Yes**, to cancel press **No**. If the option is disabled, the selected orders will be immediately sent into the Trading system. You can disable the confirmation option right in the warning confirmation window by setting **Do not show next time**.

6.2.8.5. Import

You can import data from a text file into the postponed orders window by the following ways:

- by pressing the button  on the local instrument panel;
- via the context menu item **Import**.

The output file format is CSV, which is also used for exporting data. This file format has the following characteristics:

- UTF-8 charset with BOM;
- semicolon as separator ` ,`;
- double quotes are doubled in each field;
- if there is a new line character, semicolon or double quotes symbol in the field, the entire field will be framed with double quotes.

To continue with importing press **Yes**, or press **No** to cancel. To prevent the warning message from displaying, please use the option **Postponed orders import confirmation (Settings/ Terminal settings/ Main/ the Confirmations tab)**; either you can uncheck the option **Do not show next time**. The option is enabled by default.

When you import data from a file, a window appears on the screen, where you should select a certain file to import data from by selecting it with the mouse cursor and pressing the button **Open**.

The **Data import wizard** is used for importing data:

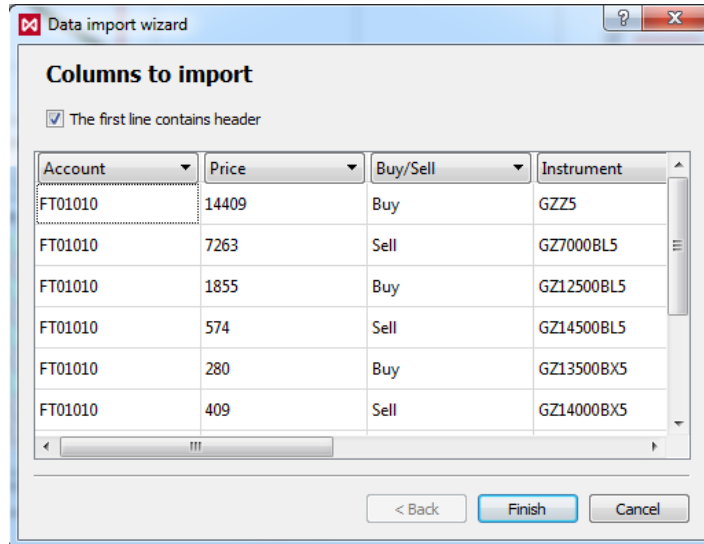

Fig. 6.41. Data import wizard

The checkbox **The first line contains header** allows to assign the first line in the file as the columns' header. This means that if the option is active, the columns in the table will be automatically named in accordance with the original table columns' names.

Each field in the table contains a drop-down list of possible columns' names. If a column has been automatically assigned with an incorrect name, you can select a proper name for a column manually.

- parameters mandatory for importing a line. The columns' names with these parameters are marked with bold;
- additional parameters, containing some optional non-mandatory data. The columns' names with these parameters are displayed in regular font.

You will be noticed about the data mandatory for import with a special reminder in red colour in the bottom of the form. You will not be able to complete the data import procedure in case of absence of any mandatory data, as the button **Finish** will stay inactive.

Please note, that The Data Import Wizard main form can display only the first 9 or 10 lines of imported data.

When all imported data are correct, the button **Finish** will get active. You should complete the data import procedure by pressing the button.

When importing is in progress, a dialog box with the progress-bar appears on the screen. Using this dialog box, you can cancel importing at any time you wish (please note, that neither of lines will then be stored, and you will have to import the entire data anew, if needed). Should there be any errors importing, you can find the details in the application log window (see section 6.7.2). When importing is completed, a window appears on the screen containing information about imported data status (successful/unsuccessful/incomplete).

Please note, that, when importing, a new adding line will always replace a previously imported line with the same key (where 'key' is the combination of instrument short code+instrument complete code+price value+order direction); in

this case, an appropriate warning message will appear (see section 6.7.2). You can edit the list of imported orders before adding them into the trading system.

The settings **Floor**, **Board** and **Counterparty** are not mandatory when importing data into the postponed orders window. If they are not set, the default board will be set as **SPECTRA**. The board is selected according to the instrument (anonymous by default). If an order contains any value in field **Counterparty**, then the board will be set as is negotiated.

All imported data will be displayed in the window **Postponed orders**. All previous data in the window will then be replaced with the new ones.

6.2.9. Dynamical order adding

Working with the trading terminal, you can dynamically import orders from a CSV file. The format CSV represents a text file with semicolon as separator.

```
account;price;buysell;sec_name;sec_code;pos;comment
FT00000;81900;Buy;RIM6;RTS-6.16;3047;
FT00000;82740;Sell;RIH6;RTS-3.16;13495;
FT00000;7740;Sell;RI75000BC6;RTS-3.16M170316CA 75000;186;
FT00000;17260;Buy;RI100000BO6;RTS-3.16M170316PA 100000;7;
FT00000;12740;Sell;RI70000BC6;RTS-3.16M170316CA 70000;129;
FT00000;10;Buy;RI65000BO6;RTS-3.16M170316PA 65000;637;
```

Fig. 6.42. Data structure in CSV file

By dynamical order adding it is meant that the order pool in the order book will be automatically changed according to changes applied to orders the CSV file.

You can dynamically add orders using an appropriate window. The window can be evoked via the main menu item **Trading/ Dynamical order adding**.

The screenshot shows a window titled 'C:/111/Programms/QGUL/EXPORT1.csv - Dynamical order adding'. It contains a table with the following columns: Order number, Instrument, State, Price, Q-ty, Volume, Remains, Time, Account, and Comment. The table lists several orders with their respective details. Below the table is a log window showing the following messages:

```
29.02.2016 18:09:11: Order has cancelled (Operation successful.): Account=FT01003, BoardId=14, SessId=5051, StockId=1, order_id=40412582967
29.02.2016 18:09:11: All orders have cancelled
29.02.2016 18:09:12: Lines successfully imported: 4
29.02.2016 18:09:12: Order has imported:Account=FT01003, BoardId=14, BuySell=S, Comment=, DateExp=, Price=10, Quantity=79, Security=RTS-3
29.02.2016 18:09:12: Order has imported:Account=FT01003, BoardId=14, BuySell=B, Comment=, DateExp=, Price=37160, Quantity=396, Security=F
29.02.2016 18:09:12: Order has imported:Account=FT01003, BoardId=14, BuySell=B, Comment=, DateExp=, Price=20, Quantity=301, Security=RTS-
29.02.2016 18:09:12: Order has imported:Account=FT01003, BoardId=14, BuySell=B, Comment=, DateExp=, Price=250, Quantity=1234, Security=R1
29.02.2016 18:09:12: Order has added:Account=FT01003, BoardId=14, BuySell=S, Comment=, DateExp=, Price=10, Quantity=79, Security=RTS-3.1
29.02.2016 18:09:12: Order has added:Account=FT01003, BoardId=14, BuySell=B, Comment=, DateExp=, Price=37160, Quantity=396, Security=RTS-
29.02.2016 18:09:12: Order has added:Account=FT01003, BoardId=14, BuySell=B, Comment=, DateExp=, Price=20, Quantity=301, Security=RTS-3.
29.02.2016 18:09:12: Order has added:Account=FT01003, BoardId=14, BuySell=B, Comment=, DateExp=, Price=250, Quantity=1234, Security=RTS-
```

Fig. 6.43. Dynamical order adding

Tab. 6.23. Dynamical order adding window parameters

Parameter	Details
Floor	Floor short name.
Order number	Order sequential number.

Parameter	Details
Instrument	Instrument short code.
Code	Instrument code.
State	Order status (active, executed, removed).
Expiration date	Order expiration date.
Price	Order price.
Q-ty	Amount in operation.
Volume	Order price (money).
Available	Remaining amount in order.
Time	Time of placing order.
Account	Client code.
Code of firm	Code of firm which owns the order.
Session	Session name.
Board	Instrument board.
Buy/ sell	Order type.
Login	User login.
External id.	External number of transaction.
Comment	Order additional details.
Counterparty account	Code of client who receives the order.
Counterparty	Code of firm which receives the order.
Rate	Order rate in percent.
Swap price	Order rate in point.
Price1	Opening trade price.
Price2	Closing trade price.
Cancel time	Order cancel time.
Yield	Yield on futures on interest rates.
Initial number	The order's ID number, assigned to an order upon its initial listing in the trading system. This initial ID number remains the same, no matter how many times the order is relisted, so that it would be easier to find an unmatched order later after it has been relisted for another trading session.
Master login	Master login
Request to NCC	A request submitted to National Clearing Centre in order to settle a Trading Participant's obligations against a Clearing Participant, also in case of the Trading Participant's insufficient amount of collateral.

Not all of the parameters are displayed in the window by default. To know how to show or hide parameters from the window, or how to change its order of appearance see section 11.3

The window **Dynamical order adding** consists of two panels:

- The upper panel contains the list of orders added to the trading system from a CSV file. There is no other orders in the list except ones imported from a CSV file!
- The lower panel contains a history log for performed actions. Each line here contains date, time and description of the performed action. The error messages are marked with red.





You can change sizes of the panels by moving the border between them with mouse. To hide/show the lower panel (**History** panel) please use the button **Hide History panel**.

To perform an action in this window, you should either use an appropriate button of the local instrument panel (see tab. 6.24) or a context menu item. Please note, that the orders displayed in the upper panel are not subject to be added or removed via the context menu. Below are the actions which can be performed using the context menu opened from the order list:

- open window **All trades/ requests** for a selected instrument (the one in the line under the mouse cursor);
- Open order book window for a selected instrument;
- add a chart for a selected instrument;
- add a volatility curve.

For description of standard context menu items available in all windows see Chapter 11.

Tab. 6.24. Buttons of instrument panel in window Dynamical order adding

Icon	Name	Details
	Run	Start importing orders from the selected CSV file.
	Stop	Stop synchronize orders with ones in the file.
	Select a file to import	Select a CSV file to import orders from.
	Hide /Show History panel	Hide/show the History panel. The panel is shown by default.

To start importing orders from the selected file, use the button  of the local instrument panel. The orders then will be added into order book (in case there were no errors in importing).

If you have not selected any CSV file before pressing the button **Run**, you will then be able to select it using the standard file selection window (see fig. 6.44) and specifying parameters for importing (see fig. 6.45). You can also select a CSV file in advance, using the button  of the instrument panel to open a standard file selection window.

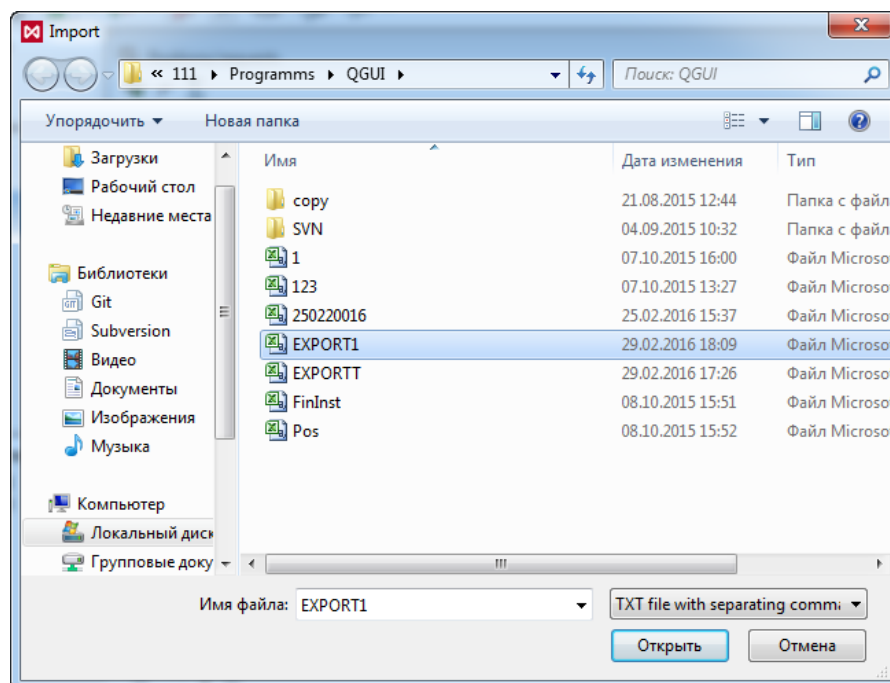

Fig. 6.44. File selection

After a file for importing has been selected, the window **Data import wizard** appears on the screen to specify parameters of the imported orders:

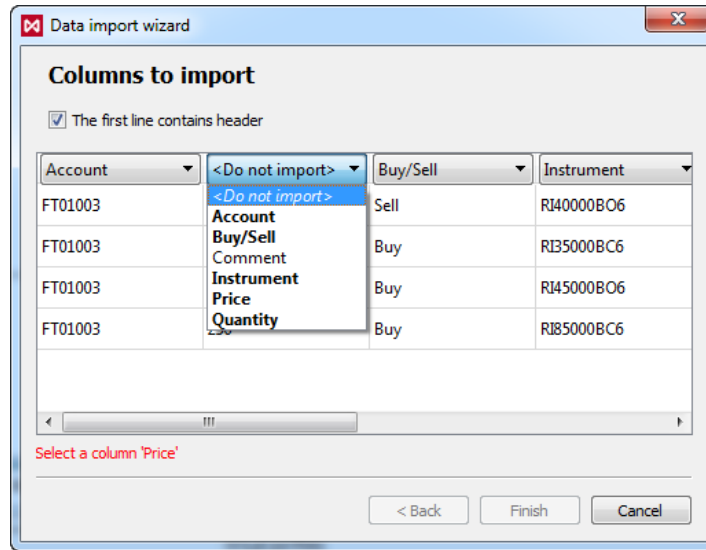



Fig. 6.45. File selection window

If there is a required import parameter missed, a warning red message will appear in the **Data import wizard** window. Note that the button **Finish** stays inactive until all the parameters required for importing are properly specified. Once you have specified all the required parameters, the button **Finish** will become active; press it to finish setup and close the window **Data import wizard**.

If the imported file properties such as its name and location are not subject to change, you then are able to specify the file import parameters only once. Later, when the dynamical import procedure is already on, in case of any change within the imported file (its properties or its content), all the previously added imported orders will be cancelled, new data will be imported from the file and then added into order book.

In case of any failure, all previously added orders will be cancelled, and importing process will halt. This may happen, for example in case of the following:

- when there is a error occurs while importing the file data;
- when you are unable to add at least one order. For example, when importing, a new adding line will always replace a previously imported line with the same key (where 'key' is the combination of instrument short code+instrument complete code+price value+order direction); in this case, an appropriate warning message will appear (see section 6.7.2). You can edit the list of imported orders before adding them into the trading system.
- when there is a error occurs on any order cancellation transaction except the **Order not found** one;
- when the dynamical adding window closes;
- when you manually stops importing by pressing button 
- when a new clearing or trading session starts.

You can arrange the order list by any column you like. To arrange orders, double-click the left mouse button on the column's name; to change the arranging order, just double-click the column name again. By default, all orders are arranged by time of adding orders into order book.

The current configuration (columns, window size, color scheme, selected file and import parameters) can be saved for later usage. Please note that the current status (on/off) and the active orders list will not be saved!

6.2.10. Unprocessed orders

The **Unprocessed orders** section of the side panel contains the orders rejected by trading system for some reason. To open the side panel use the **View/ Show side panel** main menu item or the **Ctrl+L** key combination.

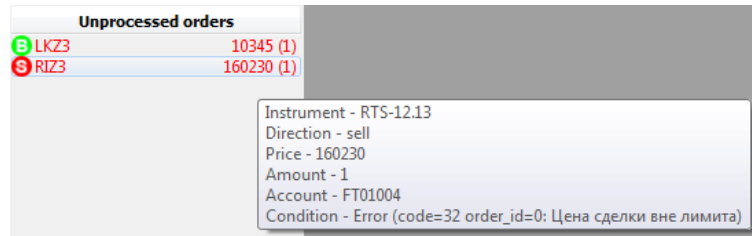

Fig. 6.46. Unprocessed orders

For example, if you try to add an order with the price beyond limits, then this order will not be added into the trading system and will be moved into the unprocessed orders list instead.

If you place the mouse cursor over an order in the unprocessed order list, a small window will appear with the order parameters and the rejection reason - see fig. 6.46.

From the context menu, opened by clicking an unprocessed order in the list with the right mouse button, the following options are available:

- **Repeat order** – opens the order adding window filled in with the unprocessed order parameters; the parameters can be edited before adding the order ;
- **Cancel order** – the order will be cancelled and removed from the list of unprocessed orders. This menu item is available only for the orders that were responded;
- **Remove from list** - the order will be removed from the list of unprocessed orders. This menu item is available only for the orders that were not responded. Please note, that the orders will be merely removed from the list, but not cancelled!
- **Cancel all orders** – clears the unprocessed orders list.

This section also contains a button which allows to remove transactions which are left in transport queue for some reason - fig. 6.47. Please note that the button is not shown when the transport queue is empty.

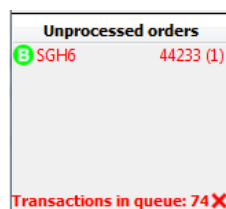

Fig. 6.47. Transaction queue clearing button

The number left of the button displays the transaction queue size (number of transactions in queue). To clear the queue press **X**.

This may be useful, for example, when there is a transport halt right after a huge amount of orders had been sent into order book. In this case, you are unable to reestablish connection without proceeding sending the whole amount of orders left in queue into the system. So that, the button **X** will help to clear the queue and reestablish your connection to the transport anew.

6.2.11. Order cancellation

You can remove only the orders added by you. You can remove orders in the one of the following ways:

- via the **Your orders/ requests** window, by double-clicking the left mouse button on the active order;
- via the **Cancel order** context menu item (opened from the **Your orders/ requests** window by clicking the right mouse button on the active order);
- by clicking the left mouse button on an order in the **Orders panel** of the **Order-book** window (if the **Orders** panel is enabled).

You can perform the order mass cancellation according to their parameters:

- via the **Cancel orders** context menu item opened from the **Order-book**. In this case, all orders for the selected instrument (for which the order-book window has been open) will be cancelled according to the client or BF account. All the commands below are available only when a client account has been selected in the **Account** field on the **Trading** tab in **Window settings**:
 - **Cancel all orders - Shift+A** - removes all user's orders for the current instrument;
 - **Cancel all buy orders - Shift+B** - removes all user's buy orders for the current instrument;
 - **Cancel all sell orders - Shift+S** - removes all user's sell orders for the current instrument;

The result of the order mass cancellation strictly depends on the user role in the trading system (CF, BF or client).

In case of the client user role, all the orders added from the current account will be removed (all orders, buy orders or sell orders, depending on the command executed).

In case of the BF user role (when BF code - 4 symbols specified in the Order-book window settings), all BF orders will be removed (including all BF accounts and clients). If a client account code has been specified in the Order-book window settings, then only orders added from this account will be removed.

In case of the CF user role, a client account code is mandatory to be set (not less than 4 symbols). If a BF account code has been specified (4 symbols), then the orders added from the BF accounts will be removed. If a client account code has been specified (7 symbols), then only the orders added from the client accounts will be removed.

- by pressing the one of the key combinations above, if the **Order-book** window is open and active;
- via the **Trading/ Cancel orders** main menu item. In this case, all orders for the selected instrument will be cancelled for the selected client or BF account. You can additionally select the orders to cancel: **Cancel all orders**, **Cancel all buy orders**, **Cancel all sell orders**. After that, you will have to enter a floor and a client or BF account code to cancel orders for:

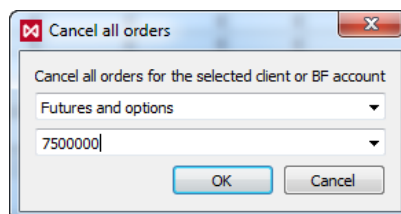

Fig. 6.48. Cancel all orders

You can set a special confirmation at order cancellation in the **Confirmations (Settings/ Terminal settings/ Main)** tab, via the **Order cancellation confirmation** and the **All orders cancellation confirmation**. If the options is enabled, you will receive a confirmation dialog before cancellation is done. To disable the confirmation dialog, activate the **Do not show next time** option in the confirmation dialog window by checking the appropriate checkbox.

6.2.12. Checking price for limits and multiplicity

If you are adding an order when some price limits are specified for the instruments, then the **Check for limits** window will appear on the screen:

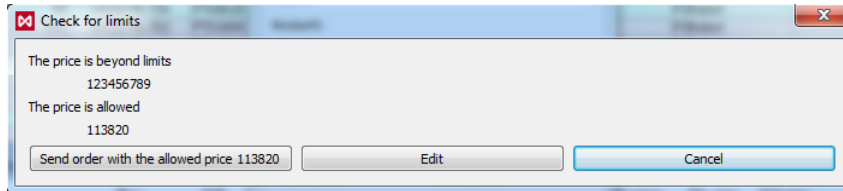

Fig. 6.49. Check for limits window

If you are trying to specify a price value in the order adding window, which is not multiple to the specified price step, then the **Check for multiplicity** window will appear on the screen:

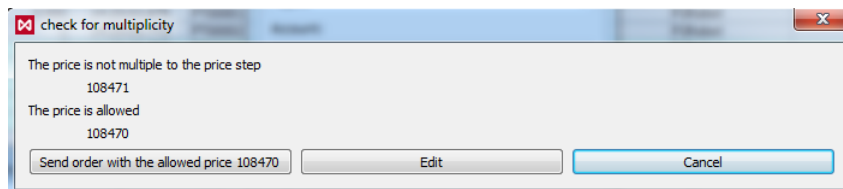

Fig. 6.50. Check for multiplicity window

You can resolve these problems in the following ways:

- by pressing the **Send order with the allowed price ...** - the allowable price (indicated on the button) will be set automatically; after that, the order will be added into the trading system;
- by pressing the **Edit** button - the order adding window will appear on the screen, with the **Price** field containing the recommended value. You can either accept the recommended value, edit it, add order into the system or cancel adding;
- by pressing the **Cancel** button - the order adding will be cancelled. Both the dialog and the order adding window will be closed.

6.2.13. Messages window

The **Messages** window contains the messages the system sends in reply to user's actions.

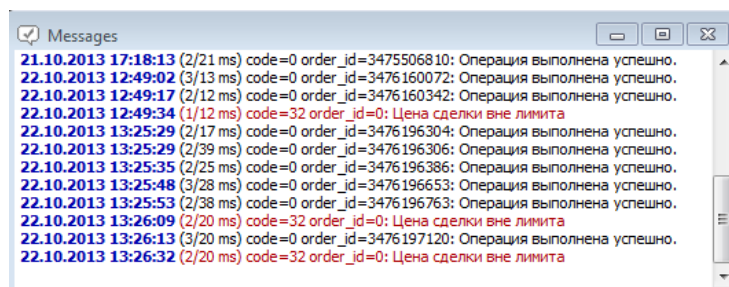

Fig. 6.51. Messages window

All messages in the window are displayed in the list. The newest message are displayed in the bottom of the list.

Every message contains the exact date and time of message generation.

Please note, that only the current session messages are displayed in the window. If you shut down the application and launch it again, the window will reopen empty.

6.2.14. Risk balancing

In order to provide a possibility to balance risk between the Derivatives Market and FX Market, there are dedicated trading board **Risk balancing (negotiated)** along with special risk instruments featured. In spite of bearing the word 'negotiated', this board does not require to specify a counterparty name, as the central counterparty is always the only counterparty in the risk balancing trades.

To add a risk balancing request, you should use the standard order adding form with the appropriate trading board selected (**Risk balancing (negotiated)**). For all available order adding form scenarios see section 6.2.3.

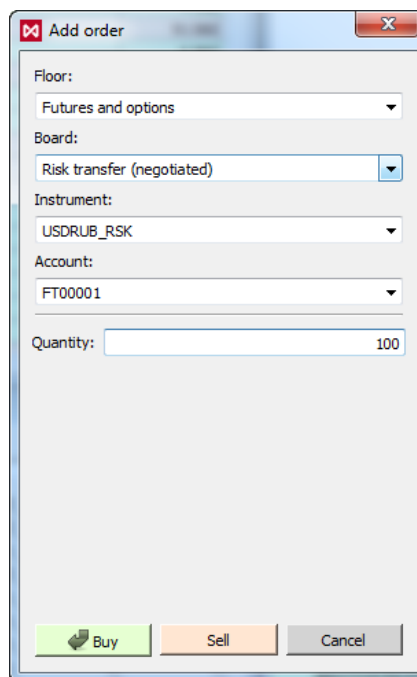

Fig. 6.52. Adding a risk balancing request

Tab. 6.25. Risk balancing request parameters

Parameter	Details
Floor	Shortened name of a trading floor
Board	Select Risk balancing (negotiated)
Instrument	Instrument code for adding request. Please note that after selecting the risk balance board, the drop-down list will contain only risk-instruments.
Account	Client code to balance risk for.
Quantity	Volume of the balanced position.

The risk balancing requests are listed in the window **Your orders/ requests**. The requests can be arranged by board name - see section 5.10.4.

6.3. Trades

The trades windows contain all trades for all trading boards: futures, options, negotiated trades, multi-leg trades.

The multi-leg trades divide into two trades each, which therefore are put into separate trading boards: spread and futures, for example.

There are two windows in the system to display trades:

- **Your trades/ requests;**
- **All trades/ requests.**

6.3.1. All trades/ requests window

In order to view all trades for the current trading session, you should use the **All trades/ requests** window. You can open it via the **Tables/ All trades/ requests** main menu item.

Floor	Board	Trade number	Session day	Session	Instrument	Time	Price	Q-ty	Volume
Futures and options	Futures	34 525 223	14.10.2013	14.10.2013	RIZ3	15:31:56.354	148 160	1	95 612,3
Futures and options	Futures	34 525 224	14.10.2013	14.10.2013	RIZ3	15:31:56.991	148 150	1	95 605,9
Futures and options	Futures	34 525 225	14.10.2013	14.10.2013	RIZ3	15:31:59.724	148 160	2	191 224,7
Futures and options	Futures	34 525 226	14.10.2013	14.10.2013	RIZ3	15:31:59.751	148 160	1	95 612,3
Futures and options	Futures	34 525 227	14.10.2013	14.10.2013	RIZ3	15:32:01.082	148 160	3	286 837,1
Futures and options	Futures	34 525 228	14.10.2013	14.10.2013	RIZ3	15:32:01.213	148 150	1	95 605,9
Futures and options	Futures	34 525 229	14.10.2013	14.10.2013	SIZ3	15:32:01.509	32 567	1	32 567,0
Futures and options	Futures	34 525 230	14.10.2013	14.10.2013	RIZ3	15:32:02.095	148 160	3	286 837,1
Futures and options	Futures	34 525 231	14.10.2013	14.10.2013	RIZ3	15:32:03.741	148 150	2	191 211,8
Futures and options	Futures	34 525 232	14.10.2013	14.10.2013	RIZ3	15:32:03.949	148 160	3	286 837,1
Futures and options	Futures	34 525 233	14.10.2013	14.10.2013	RIZ3	15:32:03.949	148 160	4	382 449,5

Fig. 6.53. All trades/ requests window

It is possible to arrange the trades in the window by time by pressing the **Time** column header. For more information see section 5.10.2.

If you click the last trade line with the left mouse button, the cursor will be docked there and will not move up or down in the window. The very last trade is always displayed either in the top or in the bottom of the window, depending on the **Time** sorting option.

The trades list can be filtered by different parameters. For more information see section 6.3.1.1. After the filtering has been enabled, the column header will be marked in bold.

The **All trades/ requests** window provides possibility of the contextual search (see section 5.10.3). To enable the contextual search, press the **Ctrl+F** key combination.

The **All trades/ requests** window allows to specify different colour schemes for the buy and sell trades (green and red, by default, according to the trade closing order) via the **Window settings** context menu item of the **View** section, the **Highlight strings** command. You can choose some other colour schemes in the **Window settings/View/ Colours settings...** context menu item (see Chapter 11).

By double-clicking the left mouse button on a trade in the list, you will open a graphical chart window for the instrument from the trade.

Tab. 6.26. All trades/ requests window parameters

Parameter	Details
Floor	Floor short name.
Board	Instrument board.
Trade number	Trade sequential number.
Session	Trade date
Instrument	Instrument short code.
Code	Instrument code.

Parameter	Details
Price	Trade price.
Q-ty	Quantity of lots/ pieces in trade.
Volume	Trade price (money).
Open interest	Amount of positions on instrument after trade.
Time	Time of trade.
Originator	Direction of order of the trade originator.
Rate	Trade price in percent. Negative value is available.
Swap price	Trade price in points. Difference between the first and the second legs price in multi-leg trades.
Price1	Opening trade price for multi-leg instruments.
Price2	Closing trade price for multi-leg instruments.
Base instrument	Underlying instrument code.
Status	Indicative trade status. Available status value for IQS indicative trades: <ul style="list-style-type: none"> • SPECTRA error • Not confirmed • Undefined error The missing field indicates a successful indicative trade.
Yield	Yield on futures on interest rates.

6.3.1.1. Filtering in the All trades/ requests window

Filtering schemes in the **All trades/ requests** window can be specified in the following ways:

- via the **Add filter** context menu item. Filtering will be applied according to parameter under the cursor. If a parameter under the cursor is not applicable for filtering, then this menu item will be absent in the context menu. The list of parameters applicable for filtering can be found via the **Window settings/ Filters** context menu item;
- via the **Filters** context menu item, available from the following columns' headers: **Remains**, **Status**, **Buy/sell**. To activate filtering, you should select the needed parameters in the drop-down list by checking the checkboxes next to each parameter name;
- via the **Window settings** context menu item in the **Filters** section.

You can apply filtering by a particular instrument in the following ways:

- via the **Select instrument** context menu item, which is available only from the **Instrument** column's header. The **Select instrument** window appears on the screen (see section 5.11.1), where you can select a needed instrument. After selection is done, the **Your orders/ requests** window will contain only the orders for the selected instrument;
- via the **Add filter** context menu item, when the context menu is opened from a cell in the **Instrument** column (the filter will be applied by the instrument code in the cell);
- via the **Window settings** context menu item of the **Filters** section.

If a filter has been applied to a column in the **Your orders/ requests** window, then the column's header will be marked in bold.

To apply all possible filters at once you should use the **Window settings/ Filters context menu item**:

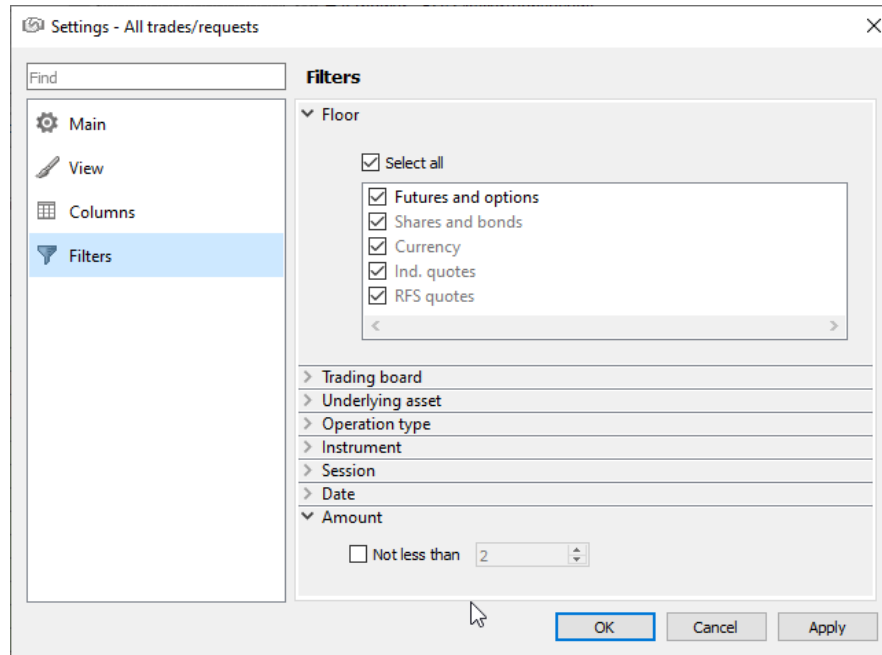

Fig. 6.54. Filtering settings in the All trades/ requests window

Tab. 6.27. Filtering parameters in the All trades/ requests window

Parameter	Details
Floor	<p>Filter by trading floor.</p> <p>If the Select all option is active, then the window will contain all trades for all trading floors. If the Select all option is inactive, the window will be empty. To select the floors you need, you should select them manually by checking the appropriate checkboxes.</p> <p>The list of available floors depends on the settings on the Transport tab (Settings / Terminal settings) - some records in the list may remain inactive (they highlighted gray color).</p>
Board	<p>Filtering by trading board. If the Select all option active, the window will contain all orders for all trading boards.</p> <p>To select some particular trading boards, you should check the checkbox next to the board name.</p>
Underlying asset	<p>Filter by underlying asset. If the Select all option is active, then the window will contain all trades for all underlying assets. If the Select all option is inactive, the window will be empty. To select the underlying assets you need, you should select them manually by checking the appropriate checkboxes.</p>
Operation type	<p>Filtering by operation type:</p> <ul style="list-style-type: none"> • Buy – only user's buy trades are displayed; • Sell – only user's trades orders are displayed. <p>You can select one of the operation types or both at once.</p>
Instrument	<p>Filtering by instrument:</p> <ul style="list-style-type: none"> • All Instruments – all orders for all instruments; • Instrument – all orders for the selected instrument. Instruments can be selected in the Select instrument window (see section 5.11.1), which can be opened by pressing the Select button.
Session	<p>Filtering by session:</p>

Parameter	Details
	<ul style="list-style-type: none"> • Active – the orders only for the current active session; • Inactive – the orders for available done session.
Date	Filtering by date: <ul style="list-style-type: none"> • All dates – all trades for the current and previous active sessions; • Today – only trades for today's sessions; • Today and tomorrow – trades for today's and yesterday's sessions; • Between - trades for a particular period of time. You can specify period in the following ways: <ul style="list-style-type: none"> • the From and till options are not set – all available dates; • only the From option is set – the dates starting from the date specified till today; • only the till option is set – the dates starting from the oldest available date till the date specified; • the both From and till options are set – all dates starting from the date specified in the From field till the one specified in the till field.
Quantity	Filtering by the instrument quantity (in lots or in units). To activate the filter you should enable the Not less than option by checking the appropriate checkbox and enter the value you need ('2' or more). After activating the filter, the All trades/ requests window will display only the orders according to the filter settings.

You can deactivate filtering using one of the following methods:

- via the **Clear filter** context menu item, which should be opened from the **Floor** column header. If a filter has been applied to a column (parameter) in the **Floor** window, then the column header will be marked in bold;
- via selecting all parameters in the **Filters** context menu item, which should be opened from the **Type** column header;
- via the **Remove all filters** context menu item;
- via selecting all parameters in the **Filters** section of the **Window settings** context menu item.

6.3.1.2. Context menu in the All trades/ requests window

For information about the standard commands for all windows see Chapter 11. Below is the list of the **All trades/ requests** window menu items:

- **Add order at <instrument code>** – opens the standard form for the selected instrument ;
- **Request to NCC for <instrument code>** – opens the request to NCC window for the selected instrument (see section 6.2.5);
- **Open all trades for <instrument code>** - opens the **All trades/ requests** window, with a filter applied according to the selected instrument;
- **Open Order-book** – opens the Order-book window for the current instrument (right on the active tab). The instrument ticker is displayed in the context menu item;
- **Open chart** (the default action) – opens the **Tech. Analysis** window with the graphical chart for the current instrument;
- **Add volatility curve** - adds the volatility curve chart into a separate window (see section 7.3). This menu item is available only for options;

- **Information** - opens the **Information** window for the selected instrument;
- **Add filter** – enables filtering according to the parameter where cursor was placed. The parameter name is available in a menu item. Please note, that the menu item is displayed only when the filtering option is available for the parameter selected. The list of the parameters can be found via the **Window settings/ Filters** context menu item; also, there you can specify the filtering parameters (see section 6.3.1.1);
- **Clear filter** – allows to remove the filter applied by the current column parameter (the column header will be marked in bold). The menu item is available in the context menu only when the filtering has been applied;
- **Remove all filters** - removes all filters by all parameters. The menu item is available in the context menu only when the filtering has been applied;
- **Select instrument** - opens the **Select instrument** window. After selecting an instrument, the filtering will be enabled according to the selected one instead of any other instrument selected before, if it was. This menu item is available only in context menu opened from the **Instrument** column.
- **Filters**– the menu item, available only when the context menu opens from the columns, which data can be filtered by a particular parameter (the **Originator** column, for example). In the drop-down list, you should select the filtering parameters by checking the checkbox next to each parameter name. Please note, that via this menu item, you can add or remove only a single parameter at once. For more options, please use the **Window settings/ Filters** context menu item – see section 6.3.1.1..

6.3.2. Your trades/ requests window

The **Your trades/ requests** window displays all trades performed by you during the current trading session. You can open the window by one of the following ways:

- via the **Tables/ Your trades/ requests** main menu item;
- by pressing the  button in the instrument panel;

The **Your trades/ requests** window contains all trades performed by using your accounts. The client trades (i.e., the trades performed between your accounts) are displayed as separate trades for each of your accounts.

The multi-leg trades are divided into two trades for separate trading boards: multi-leg and futures.

When you establish connection to the trading system, the **Your trades/ requests** window will display not more than the last 20 trades for each instrument.

After disabling the **Load your trades history** option via the **Settings/ Terminal settings/ Transport** main menu item, the **Your trades/ requests** window will display only the trades performed since the moment of your connection.



Trade number	Order number	Instrument	Code	Price	Q-ty	Volume	Fee
49 368 641	3 603 942 818	RIM4	RTS-6.14	115 070	1	81 933,52	2,0
49 368 633	3 603 942 759	SIM4	SI-6.14	36 300	2	72 600,00	1,0
49 368 632	3 603 942 759	SIM4	SI-6.14	36 300	81	2 940 300,00	34,5
49 368 515	3 603 941 948	RIM4	RTS-6.14	115 110	1	81 962,00	0,0
49 368 497	3 603 941 731	SRM4	SBRF-6.14	7 881	7	55 167,00	3,5
49 368 489	3 603 941 652	SIM4	SI-6.14	36 304	10	363 040,00	5,0
49 368 478	3 603 941 531	SIM4	SI-6.14	36 308	3	108 924,00	1,0
49 368 477	3 603 941 531	SIM4	SI-6.14	36 306	1	36 306,00	0,0
49 368 443	3 603 941 151	LKM4	LKOH-6.14	19 094	2	38 188,00	2,0
49 368 436	3 603 941 150	SIM4	SI-6.14	36 310	2	72 620,00	0,0
49 368 420	3 603 941 028	RIM4	RTS-6.14	115 180	1	82 011,85	2,0

Fig. 6.55. Your trades/ requests window

It is possible to arrange the trades in the window by time by pressing the **Time** column header. For more information see section 5.10.2.

If you click the last trade line with the left mouse button, the cursor will be docked there and will not move up or down in the window. The very last trade is always displayed either in the top or in the bottom of the window, depending on the arranging option.

The trades list in the **Your trades/ requests** window can be filtered by account and other parameters. For more information see section 6.3.2.1. If a filter has been applied to a column (parameter), the column header will be marked in bold.

The **Your trades/ requests** window provides possibility of the contextual search (see section 5.10.3). To enable the contextual search, press the **Ctrl+F** key combination..

The **All trades/ requests** window allows to specify different colour schemes for the buy and sell trades (green and red, by default, according to the trade closing order) via the **Window settings** context menu item of the **View** section, the **Highlight strings** command. You can choose some other colour schemes in the **Window settings/View/ Colours settings...** context menu item (see section 11.2).

When the **Play sound when adding a string** option is set, then a sound will play every time a new string is being added into the **Your orders/ requests** (or **Your trades/ requests**) table.

The sound pattern can be selected in the **Sound** field from a drop-down list (with a preview option available for every sound pattern: to preview a sound, press the appropriate button next to the **Sound** field). For more information see section 6.2.1.3.

To open the Order-book window for a trade, double-click it with the left mouse button.

Tab. 6.28. Parameters in the Your trades/ requests window

Parameter	Details
Trade number	Trade sequential number.
Order number	Order sequential number.
Instrument	Instrument short code.
Code	Instrument code.
Price	Trade price.
Q-ty	Quantity of lots/ pieces in trade.
Volume	Trade price (money).
Fee	Fee on trade.
Account	Client code.
Floor	Floor short name.
Board	Instrument board.
Session	Session name.
Direction	Own order direction.
Login	Client login.
Counterparty	Counterparty exchange code.
Time	Time of trade.
External id.	External number of transaction.
Comment	Trade additional details. If the client order contained a comment, the comment text will be added into this field.
Repo	Number of multi-leg instrument other leg.
Multi-leg	Multi-leg trade number.
Rate	Trade price in percent for multi-leg instruments. Perhaps the negative.

Parameter	Details
Swap price	Trade price in points for multi-leg instruments. Price difference between the near and far legs.
Price1	Opening trade price for multi-leg instruments.
Price2	Closing trade price for multi-leg instruments.
Trade type	Expiration/ exercise trades types.
Underlying	Underlying asset code.
Yield	Yield on futures on interest rates.
Status	<p>Indicative trade status.</p> <p>Available status values for IQS indicative trades:</p> <ul style="list-style-type: none"> • Processing • Waiting • Confirmed • Error • Trade performed
OTC error	<p>OTC service error description.</p> <p>OTC error details:</p> <ul style="list-style-type: none"> • Not confirmed • Error adding Contractor order • Error adding Initiator order • Order not found on SPECTRA • SPECTRA timeout • SPECTRA is unreachable • System error
SPECTRA error	<p>SPECTRA error code.</p> <p>For detailed information about SPECTRA error codes, see <i>p2gate_en.pdf</i> (ftp://ftp.moex.com/pub/FORTS/Plaza2/docs/).</p>
Request to NCC	<p>Request to NCC</p> <p>Possible values:</p> <ul style="list-style-type: none"> • Yes - request to NCC • No - standard order.
Liquidity stream ID	Liquidity stream ID.
Broker fee	Broker fee for the trade.
Visible order	Ordinal number of the iceberg visible part.

6.3.2.1. Filtering in the Your trades/ requests window

In the **Your trades/ requests** window, you can set filtering by account number. You can enter the account number into the field above the table manually or select it from the drop-down list. The number is case sensitive! Please note, that you should enter the whole number! The table than will display all the records belonging to the account number.

The filtering settings of the **Your trades/ requests** window are fully alike to that of the **All trades/ requests** window – see section 6.3.1.1. The difference is that the Your trade window provides two additional options for filtering (see below):

- **Account** - applies filter by the client account number. The **Select all** option allows to display trades for all the clients accounts. To select some particular client accounts you should select them by checking the checkboxes next to the account number.
- **Login** - applies filtering by login. The **All logins** option allows to display trades for all logins. You can view the trades for a particular login only; to do this, select the appropriate login in the drop-down list.
- **Trade types** - applies filtering by trade type. You can choose several types of deals at the same time. By default, all trade types are selected - all client trade are displayed in the window. Possible trade types:
 - **Standard** - all client trades except technical;
 - **Exercise** - options exercise;
 - **Expiration** - the trades that are formed when the instrument expires;
 - **Position move** - the position transfer trades;
 - **Negotiated** - the negotiated client trades;
 - **Multi-leg** - the multi-leg trades;
 - **Technical multi-leg** - the technical trades for multi-leg instruments;
 - **Indicative quotes** - the trades for indicative quotes;
 - **RFS quotes** - the trades for RFS quotes;
 - **IQS indicative trade** - the indicative trades for indicative instruments;
 - **RFS indicative trade** - the indicative trades for RFS.
 - **Indicative quotes trades only** - displays only the trades for indicative quotes;
 - **RFS quotes trades only** - displays only the trades for RFS streams.

6.3.2.2. Context menu in the Your trades/ requests window

The context menu commands are almost alike to that of the **All trades/ requests** window – see section 6.3.1.2 .

Additional command in **Your orders/requests** window is **Confirm**. This command becomes active only for indicative trades in RFS streams (trade status is **Waiting**); it is used to confirm indicative trades by a liquidity provider (login has LP rights). More details see section 6.6.5.

And second difference is the **Open Order-book** command – set as the default command to be executed by double-clicking a record with the left mouse button.

6.4. Negotiated operations

The trading terminal provides availability for adding negotiated orders and perform negotiated trades.

Negotiated and anonymous orders are displayed in the same tables; the only thing to tell one from another is the trading board they belong to (some trading boards contain the word 'negotiated' in their names). In order to view negotiated orders and trades only, you can apply the appropriate filter.

The **Your trades/ requests** window contains only your negotiated trades. The **Counterparty** in these trades field contains the counterparty ticker code.

The **All trades/ requests** window contains both your and others negotiated trades; the counterparty ticker code is not displayed though.

Users can remove negotiated orders added by them.

6.4.1. Negotiated orders

Negotiated orders are the orders addressed to a particular counterparty, therefore their details are not disclosed to other trading participants, except the two counterparties.

Two active negotiated orders are offsetting if:

- The one clearing firm code in one order coincides with that of another clearing firm, and vice versa;
- both orders are for derivatives with the same code;
- the orders have opposite directions: buy and sell, or vice versa;
- the buy order price/premium is equal or greater than the sell order price/premium.

If there is no active offsetting order found for the active negotiated order, this order enters on queue for waiting.

Negotiated and anonymous orders are displayed in the same tables in the **Your orders/ requests** window (see fig. 6.55) ; the only thing to tell one from another is the trading board they belong to (some trading boards contain the word 'negotiated' in their names). In order to view negotiated orders and trades only, you can apply the appropriate filter (see section 6.2.1.1).

The **Your trades/ requests** window contains only your negotiated trades. The **Counterparty** in these trades field contains the counterparty ticker code.

If you select a negotiated order (addressed to you) in the window and click **Add order**, the order adding window will appear on the screen, filled in with the parameters of the selected order. To perform a trade, you will have to fill in the client account code and the order direction (opposite to that of the selected order) and add the order to the trading system.

For adding negotiate orders, the standard order adding window with selected negotiated orders board is used (see fig. 6.56). For possible order adding window opening scenarios see section 6.2.3.

6.4.1.1. Adding negotiated orders

The main negotiated orders parameters are alike to that of the anonymous orders - see tab. 6.20.

For negotiated orders, the order adding window contains some additional fields:

- **Counterparty** field (see fig. 6.56) is mandatory, and it must be filled in with the counterparty data (either added manually or selected from the drop-down list);
- **Matching reference** field - this parameter's value is used for matching negotiated orders. If two values (including the empty string) match, then the orders will be matched into a trade. And vice versa, if the values do not match, the two orders will not be matched into a trade.

For possible order adding window opening scenarios see section 6.2.3.

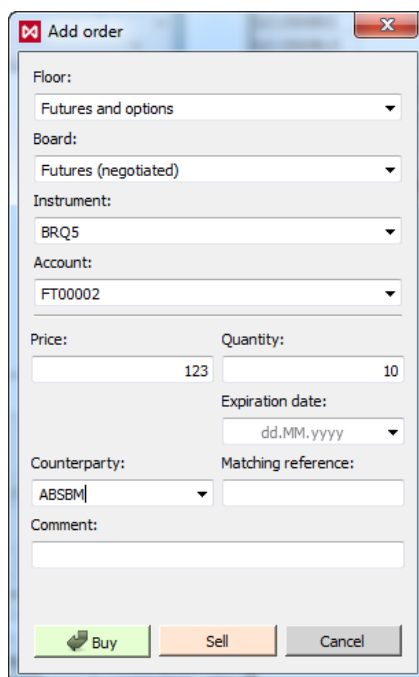

Fig. 6.56. Adding a negotiated order

6.4.2. Negotiated trades

An active negotiated order matches with opposite order to make trade. Negotiated orders cannot be matched partly.

The negotiated orders are displayed in the **All trades/ requests** (see section 6.3.1) or in the **Your trades/ requests** (see section 6.3.2) window; the filtering by **negotiated** parameter must be set.

The **Your trades/ requests** window displays your negotiated trades including detailed information regarding the trades.

The **All trades/ requests** window displays all users' negotiated trades. Information about counterparties are not included, therefore, you cannot see the details about matched trades.

6.5. Multi-leg instruments operations

Multi-leg instruments – compound instruments, which consist of several parts related to each other (spot assets, futures, options). Once the multi-leg trade has been matched, it divides into two or more instrument positions.

A multi-leg trade consists of two trades for different trading boards, with different settlement time.

Below are some particular cases of multi-leg operations:

- **Spread** - the instrument allows to trade two future orders for the same underlying asset at once, with different settlement date and opposite directions (short or long).

The multi-leg trades can be either negotiated or anonymous.

6.5.1. Multi-leg instruments orders

Multi-leg orders are displayed in the **Your orders/ requests** window (see fig. 6.55), along with anonymous orders.

You can filter order by the **Board** field. The multi-leg instruments belong to the following boards:

- Spread;
- Spread (negotiated).

Multi-leg orders in the window can also be filtered by instruments or the instrument types – see section 6.2.1.1.

There are two types of multi-leg orders: negotiated and anonymous. Negotiated orders always have the counterparty code.

For adding multi-leg orders, the standard order adding window with selected negotiated orders board is used (see fig. 6.57). For possible order adding window opening scenarios see section 6.2.3.

6.5.1.1. Adding orders for anonymous multi-leg instruments

Unlike the standard order adding window (see tab. 6.20), the order adding window for multi-leg orders contains some additional fields:

- **Swap-price** - price difference between the near and the far legs of the trade. The parameter is specified for the swap-instruments and spreads orders. The other trade parameters are based on this value.

Fig. 6.57. Adding order for the anonymous multi-leg instruments

6.5.1.2. Negotiated multi-leg instruments orders

For adding negotiated orders, the firm must be granted with special rights by the trading administrator. Negotiated orders are displayed in the **Your orders/ requests** window along with anonymous orders. Below is what you can see in the **Your orders/ requests** window:

- negotiated multi-leg instruments orders added by your brokerage firm;
- negotiated instruments orders added for your brokerage firm.

You cannot see orders addressed to another firms.

When adding a negotiated order:

- you should specify a counterparty (firm code), the order will be addressed to;
- the trading system matches the added negotiated order to an opposite order added by the specified counterpart. If no counter-order has been added into the system yet, the order remains in the system, waiting for the counter-order to be added.

The adding negotiated order parameters should meet the following requirements:

- the near leg price should not exceed the first instrument limits;
- the far leg price (the near leg price + swap-price) should not exceed the second instrument limits;
- trades between instruments with different lots are prohibited.

Fig. 6.58. Adding order for negotiated multi-leg instruments

Unlike the standard order adding window (see tab. 6.20), the order adding window for multi-leg orders contains some additional fields:

- **Swap-price** - price difference between the near and the far legs of the trade. The other trade parameters are based on this value;
- **Counterparty** – the counterparty firm code for the negotiated order.

6.5.2. Multi-leg instruments trades

There are two types of multi-leg trades: anonymous and negotiated. All types trades are displayed in the **All trades/ requests** (see section 6.3.1) and **Your trades/ requests** (see section 6.3.2) windows. For your convenience, you can filter the list by particular trading board.

The **Your trades/ requests** window displays your negotiated trades including detailed information regarding the trades.

The **All trades/ requests** window displays all users' negotiated trades. Information about counterparties are not included, therefore, you cannot see the details about matched trades.

The multi-leg trades divide into two trades each, which therefore are put into separate trading boards: multi-leg and futures.

To commit a negotiated trade, the **Counterparty** (the entity, the order has been addressed to) should add a negotiated order with the opposite direction, addressed to the originator of the initial order. The following parameters of both orders must be equal:

- trading board;
- instrument code and settlement date;
- order volume;
- swap-price.

A single negotiated order can be matched to no more than one trade.

6.6. RFS (active streams)

An auction can be initiated not only by the exchange, but also by the trading participant (LC - liquidity consumer).

The liquidity consumer (LC) initiates on-demand auction in the OTC system by submitting a request (RFS - request for stream or liquidity stream) for a particular instrument at a certain volume. In the event of a satisfactory offer from the provider, LC withdraws the liquidity provided. Any Trading Participant can be liquidity consumer the default.

Liquidity Providers (LP) are invited to the auction and have the right to submit their quotes there. A notification about the creation of a new liquidity stream is sent to all providers. It is displayed as a pop-up message in the tray and is displayed in the **Errors and notifications** window. All Trading Participants can be liquidity providers. Within one Trading Participant there can be several providers. To create/delete/change the provider, the Trading Participant must send an application to the Exchange.

Common instruments are used for RFS, but operations with them are performed on a special **Floor - RFS quotes**.

To work with the RFS platform, you must make the following settings:

- set flag **RFS quotes** in the **Floor** area of **Transport** section (**Settings/ Terminal settings** main menu item) - see section 10.17;
- you should specify the server address and connection ports in the section **RFS quotes** in the **Profiles** area of **Transport** section (**Settings/ Terminal settings** main menu item) - see section 10.17.

For convenience, **RFS** tab has been created in the default configuration of the terminal, on which the following windows are rendered: **RFS (active streams)**, **Your orders/ requests**, **Your trades/ requests**, **Errors and notifications**. Filters for RFS quotes and trades are configured in all these windows.

Operations with RFS streams are performed in a special window **RFS (active streams)** that opens via the main menu item **Tables/ RFS (active streams)**.

The window **RFS (active streams)** displays:

- requests submitted by your brokerage firm as LC. Rows with requests made from your login are highlighted in yellow (highlight setting see section 10.5). Rows with requests from other logins of your company are not highlighted in any way;
- requests made by other LCs if the BF is not only LC, but also LP. You can submit quotes to such streams as a provider;
- best offers on your liquidity streams.

This window opens via the main menu item **Trading/ RFS (active streams)**.

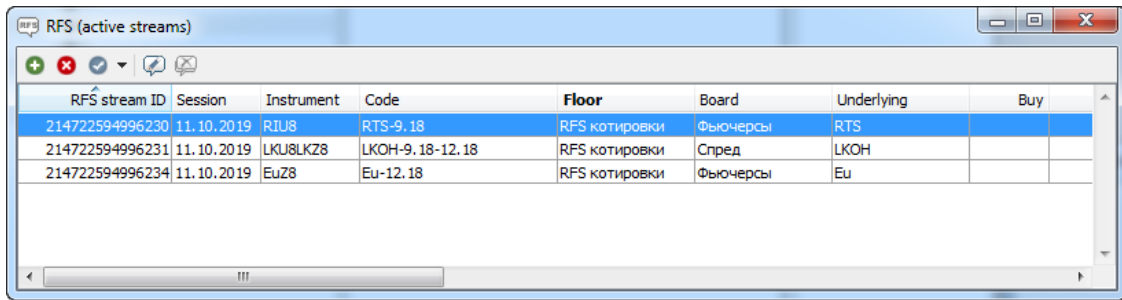

RFS stream ID	Session	Instrument	Code	Floor	Board	Underlying	Buy
214722594996230	11.10.2019	RIU8	RTS-9.18	RFS котировки	Фьючерсы	RTS	
214722594996231	11.10.2019	LKU8LKZ8	LKOH-9.18-12.18	RFS котировки	Спред	LKOH	
214722594996234	11.10.2019	EuZ8	Eu-12.18	RFS котировки	Фьючерсы	Eu	

Fig. 6.59. 'RFS (active streams)' window

Tab. 6.29. Parameters in 'RFS (active streams)' window

Parameter	Details
RFS stream ID	Liquidity stream identifier
Session	Session name
Instrument	Instrument short code
Code	Instrument code
Floor	Floor short name
Board	Instrument board
Underlying	Underlying asset code
Buy	Best buy order price
Sell	Best sell order price
Buy (market)	Current market buy price
Sell (market)	Current market sell price
LC account	Clent (liquidity consumer) account
LC login	Liquidity consumer login
LC tag	Liquidity consumer tag - anonymous code that is assigned to all clearing registers. The tag does not change with time. One tag can correspond to several clearing registers, but one register can correspond to only one tag.
Quantity	Number of instrument units in liquidity stream
Direction	Allowable orders direction for a liquidity provider: <ul style="list-style-type: none"> • buy • sell • buy and sell The liquidity stream can be one-way (only purchase, only sale) or two-way (purchase and sale).
Duration	The time interval when the stream will be available for operations: <ul style="list-style-type: none"> • until the session end • 30, 60,90 or 120 seconds
Seconds left	Time remaining before automatic closing of the stream (in seconds).

Parameter	Details
	Rows with streams close to expiration are highlighted in red (by default).
Auto-confirmation	If the option is set, then the liquidity provider can add orders only with automatic confirmation.
Speed limit	The minimum lifetime of quotes in the stream: <ul style="list-style-type: none"> • without limitation • 0,2; 0,5; 1 or 3 seconds
Comment	Liquidity consumer commentary - only LC visible
Comment for provider	Comment for liquidity provider (LP)
Indicative trade status	Status of the last indicative trade in the stream

Some fields in the **RFS (active streams)** window, such as 'best buy/ sell price' and 'quotes price trend' are highlighted in colours. Also, the rows with streams from your login are highlighted in yellow and the rows with streams close to expiration are highlighted in red. The above highlight colors can be changed at the request of the user. You can specify this settings via the **Window settings/ View** (see section 11.2) or via main menu item **Settings/ Terminal settings, Colours** section, **RFS** tab (see section 10.5).

You can switch off the colour indication options via the **Window settings: Highlight streams** context menu items of the **View** section.

You can customize the highlight objects using the appropriate options in the **View** section of the **Window settings** context menu item:

- **Highlight rows;**
- **Highlight the direction of quotes and offers;**
- **Animate highlight.**

The stream list can be sorted by any column. Sorting is done by double-clicking the left mouse button on the column header. Repeat the action changes to the opposite order.

The stream list in the **RFS (active streams)** window can be filtered by the code of the underlying asset, the code of the instrument and other parameters - see detailed description of the use of filters in section 6.6.2. If the stream list is filtered by some parameter, then the column heading with this parameter is marked in bold.



By double-clicking the left mouse button on a stream in the list, you will open an **Order-book** window for the instrument from the selecting stream. From the **Order-book** window, you can quickly open the adding order window by selecting a quote with a suitable price in it - the adding order window will be partially filled already.



The standard context menu items are described in Chapter 11.

Full list of possible commands executed in the **RFS (active streams)** window see section 6.6.1.

6.6.1. Toolbar in the 'RFS (active streams)' window

Tab. 6.30. Toolbar of the 'RFS (active streams)' window

Icon	Context menu command	Details
	Add liquidity stream	Opens a window for creating a new liquidity stream - see section 8.7.2.
	Stop auction	Stops the selected auction. Only a liquidity consumer (LC) can stop an auction, choosing only its own liquidity streams - see section 6.6.6.
	Accept quote:	The button initiates the process of adding a matching order from LC in response to an offer from the provider.

Icon	Context menu command	Details
	<ul style="list-style-type: none"> • Sell (accept purchase) • Buy (accept sale) 	<p>The button contains a submenu:</p> <ul style="list-style-type: none"> • Sell (accept purchase) at a price... • Buy (accept sale) at a price ... <p>The items in this menu become available only if the cursor is positioned on a line with consumers own stream, for which there is an offer from the provider.</p> <p>LC can accept quotes only at the best price. - it is displayed in a window in columns Buy and/or Sell.</p> <p>More details see section 6.6.5.</p>
	Add/ Change quotes	<p>The button is active only for liquidity providers.</p> <p>The button opens the quote entry form, partially filled with liquidity stream parameters. The provider can set the price and choose the direction of the quote (if the auction is two-way).</p> <p>If an offer from this provider has already been put up in the current liquidity stream, then provider can change it. In fact, a new offer with a new price is simply entered, which replaces the previous one.</p> <p>More details see section 6.6.4.</p>
	Cancel quotes	<p>Cancels provider quotes. Allows you to cancel single quotes or quotation groups.</p> <p>The button is active only for the liquidity provider, if there are active offers from it in the current liquidity stream.</p> <p>More details see section 6.6.4.1.</p>

6.6.2. Filters in 'RFS (active streams)' window

Filtering schemes in the **RFS (active streams)** window can be specified in the following ways:

- via the **Add filter** context menu item. Filtering will be applied according to parameter under the cursor. If a parameter under the cursor is not applicable for filtering, then this menu item will be absent in the context menu. The list of parameters applicable for filtering can be found via the **Window settings/ Filters** context menu item;
- via the **Window settings** context menu item in the **Filters** section.

You can apply filtering by a particular instrument in the following ways:

- via the **Select instrument** context menu item, which is available only from the **Instrument** column's header. The **Select instrument** window appears on the screen (see section 5.11.1), where you can select a needed instrument. After selection is done, the **RFS (active streams)** window will contain only the orders for the selected instrument;
- via the **Add filter** context menu item, when the context menu is opened from a cell in the **Instrument** column (the filter will be applied by the instrument code in the cell);
- via the **Window settings** context menu item of the **Filters** section.

If a filter has been applied to a column in the **RFS (active streams)** window, then the column's header will be marked in bold.

You can apply all the possible filtering options at once via the **Window settings/ Filters** context menu item:

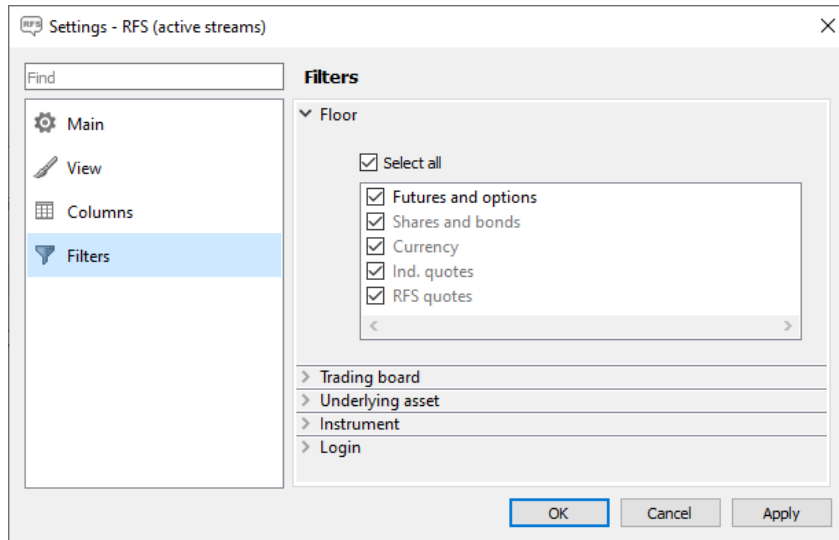

Fig. 6.60. Filtering settings in the 'RFS (active streams)' window

Tab. 6.31. Filtering parameters in the 'RFS (active streams)' window

Parameter	Details
Floor	<p>Filter by trading floor.</p> <p>If the Select all option is active, then the window will contain all streams for all trading floors. If the Select all option is inactive, the window will be empty. To select the streams you need, you should select them manually by checking the appropriate checkboxes.</p> <p>The list of available floors depends on the settings on the Transport tab (Settings / Terminal settings) - some records in the list may remain inactive (they highlighted gray color).</p>
Trading board	<p>Filtering by trading board. If the Select all option active, the window will contain all requests for all trading boards.</p> <p>To select some particular trading boards, you should check the checkbox next to the board name.</p> <p>Three trading modes are available for RFS quotes:</p> <ul style="list-style-type: none"> • Futures • Options • Spread
Underlying asset	<p>Filtering by underlying assets. If the Select all option active, the window will contain all requests for all underlying assets.</p> <p>To select some particular underlying assets, you should check the checkbox next to the underlying assets codes.</p>
Instrument	<p>Filtering by instrument:</p> <ul style="list-style-type: none"> • All Instruments – all requests for all instruments; • Instrument – all requests for the selected instrument. Instruments can be selected in the Select instrument window (see section 5.11.1), which can be opened by pressing the Select button.
Login	<p>Filtering by login, from which requests are made:</p>

Parameter	Details
	<ul style="list-style-type: none"> • All logins – all requests added by all logins; • Login – only the requests added by a particular login. The login can be selected in the drop-down list

You can remove filter by the following ways:

- via the **Clear filter** context menu item – allows to remove the filter applied by the current column parameter (the column header will be marked in bold). The item is available in the context menu only when the filtering has been applied;
- via the **Window settings/ Filters** context menu item. To remove filter, set all parameters as visible;
- via the **Remove all filters** context menu item - but all filters will be removed.

Please note, that if you closed the **RFS (active streams)** window and then opened again, the filter settings you had applied will be lost. To prevent it, you should save the workspace configuration before closing the window as the default configuration using the **Current window/ Save by default** main menu item.

6.6.3. Creating liquidity stream

The liquidity consumer (LC) sends a special request to the system to generate a liquidity stream for a particular instrument at a certain volume. The request is checked for volume restrictions (should not be less than the minimum lot for the instrument) and the limit size of the client adding this request.

The duration of a liquidity stream may be set (by default, all liquidity streams end at the end of the trading session).

The request parameters for opening a new liquidity stream are entered in a special window **Add liquidity stream**, which opens in one of the ways from the **RFS (active streams)** window:

- by click on the button of the local toolbar  ;
- via the context menu item **Add liquidity stream**;
- drag&drop an instrument from other windows (windows with information about instruments, trades and orders) to **RFS (active streams)** window area. In this case, the input form opens automatically partially filled with the parameters of the selected instrument.

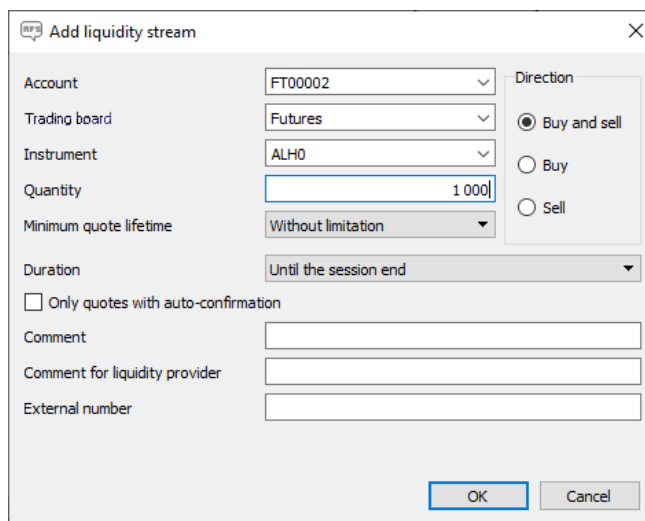

Fig. 6.61. 'Add liquidity stream' window

Tab. 6.32. Parameters in the 'Add liquidity stream' window

Parameter	Details
Account	Liquidity consumer (LC) client code
Trading board	Trading board: <ul style="list-style-type: none"> • Futures • Options • Spread
Instrument	Instrument short code
Quantity	Number of instrument units in liquidity stream The number of instrument units in the request cannot be less than the minimum lot for the underlying asset of this instrument.
Direction	Stream direction - it can be one-way (only purchase, only sale) or two-way (purchase and sale): <ul style="list-style-type: none"> • Buy • Sell • Buy and sell
Minimum quote lifetime	The minimum lifetime of quotes in the stream: <ul style="list-style-type: none"> • Without limitation (by default) • 0,2 second • 0,5 second • 1 second • 3 seconds <p>The restriction for the provider is that the provider cannot change its quotes in the stream more often than specified in this parameter.</p>
Duration	The time interval when the stream will be available for operations: <ul style="list-style-type: none"> • Until the session end (by default) • 30 seconds • 60 seconds • 90 seconds • 120 seconds <p>The stream will be closed automatically after a lifetime.</p>
Only quotes with auto-confirmation	If the option is not set (by default), then providers will be able to put quotes into this stream with or without auto-confirmation. If the option is set, then providers will be able to put quotes into this stream only with auto-confirmation. The auto-confirmation option will be set by default in the input quote form (at provider), and it will not be available for change.
Comment	Additional stream information - liquidity consumer comment (LC)

Parameter	Details
Comment for liquidity provider	Comment for liquidity provider (LP)
External number	External liquidity stream number

When creating a new liquidity stream, a confirmation message: "Are you sure you want to add a liquidity stream?", appears on the screen. Press **Yes** to add a new liquidity stream and a row with this stream will appear in the **RFS (active streams)** window, or **No** to cancel – the stream will not be open.

You can check the **Do not show next time** checkbox to disable the confirmation message.

You can specify the stream adding confirmation message settings via the **Confirmation when RFS liquidity streams managing** option in the **Settings/ Terminal settings** window, the **Main** section, **Confirmations** tab.

Attention, please! Cancellation of confirmation will apply to all operations with liquidity stream.

6.6.4. Adding quotes to the liquidity stream by the provider (LP)

When a new liquidity stream opens, all providers receive a notification, which is displayed in the tray as a pop-up message:

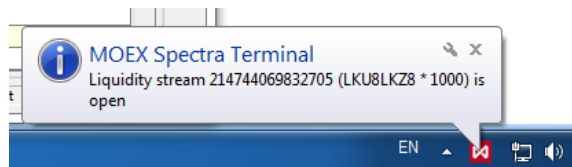

Fig. 6.62. Notification for provider

In addition to the pop-up message, information about liquidity streams is placed in the window **Errors and notifications** (cm. section 6.7.2):

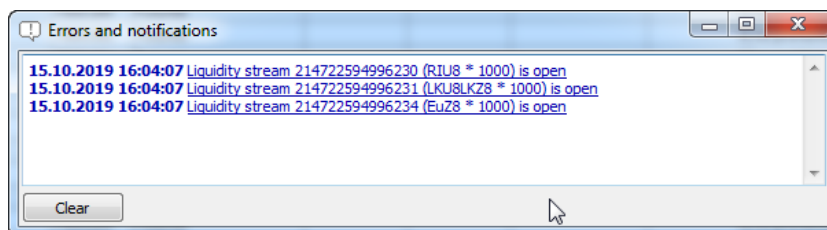



Fig. 6.63. Liquidity notification

A provider can put a quote in a stream in several ways:

- from pop-up message in the tray: the notification text is a hyperlink through which the error and notification window opens, from which you can open the quote input form by selecting the desired message;
- from **Errors and notifications** window: the notification text about the opening of a new liquidity stream is a hyperlink that opens the quote input window, and the provider can immediately put a quote in this stream without opening a window with RFS streams;
- from **RFS (active streams)** window: by the button of the local toolbar , previously setting the cursor on the line with the desired stream;
- from **RFS (active streams)** window: via the context menu item **Add/ Change quotes** opened on the line with the desired stream.

The provider puts quotes for the volume specified in the stream.

Upon submission, the quote is checked for a limit on the size of the limit and crossness with LC (provider and consumer codes cannot be the same within the same liquidity stream). If any of the checks is not passed, the quote is rejected by the trading system with the corresponding error message.

The quote is added via the standard order entry form with additional fields:

Fig. 6.64. Adding quote by LP to stream

The order entry form opens already partially filled with the parameters of the selected stream. The provider can only indicate the client account from which the quote is added and set a price. The quantity of the instrument is not indicated in the quote, since it is automatically equal to the quantity indicated in the stream, and cannot be different.

Tab. 6.33. LP quote parameters

Parameter	Details
Floor	Floor short name - RFS quotes
Board	Instrument board
Instrument	Instrument short code The value in this field is associated with the value in the Liquidity stream field. When the liquidity stream changes, the instrument code will automatically change to the one corresponding to the stream.
Account	Client (liquidity provider) account
Liquidity stream	Liquidity stream identifier In the drop-down list, only streams for the selected instrument are displayed (Instrument field).
Buy at price:	Instrument unit price
Sell at price:	If the stream is one-way, only one of the fields is available.

Parameter	Details
	<p>If the stream is two-way, then you can enter two quotes in different directions.</p> <p>Quotes prices are checked for permissibility when they are added into the system. If the entered value does not fall within the specified limits, then an acceptable price value is proposed, with which you can agree or correct the price as you wish.</p> <p>The sale price cannot be less than the purchase price.</p>
Purchase volume: Sales volume:	<p>Information fields contain the total volume of the quote (in rubles) in accordance with the indicated price. These fields are not available for editing.</p>
Limit lifetime	<p>Quotes lifetime</p> <p>If the option is set, then a field becomes available for editing in which you can enter a value from the keyboard, or via of the slider located a little lower. The value is indicated in seconds. After the specified lifetime has expired, the quote is automatically deleted from the trading system. The quote lifetime cannot be less than the minimum quote lifetime specified in the liquidity stream settings ('Speed limit').</p> <p>If the option is not set, then the quote life time is limited by the trading session.</p>
Automatic confirmation	<p>The flag of auto-confirmation when making an indicative trade. Installed by default.</p> <p>If the flag is set, then indicative trade will be concluded with auto-confirmation (without request for confirmation from the provider).</p> <p>If the flag is not set, then confirmation of the indicative trade will be requested from the liquidity provider.</p> <p>If the parameters of the liquidity stream indicate that only quotes with automatic confirmation are accepted in the stream, then the flag of automatic confirmation will be set in the quote input form and it will not be editable.</p>
Comment	<p>Liquidity provider commentary (LP)</p>

Only one quote from the provider can stand in one liquidity stream (two-way is considered as one). Provider can change the quote pressing the button on the local toolbar  or via the context menu item **Add/ Change quotes**. The old quote is deleted and a new one is put in its place. The liquidity provider can change its quotes no more often than the minimum quote lifetime specified in the stream (column **Speed limit** in **RFS (active streams)** window). Regardless of the limitation of the rate of change of quotes, the new quote will be accepted by the system if it contains a better price than the quote set earlier.

Matching RFS quotes of providers are not reduced among themselves. A provider quote (LP) can be come down to a trade only with a matching quote set by the liquidity consumer (LC).

The provider can see all of its quotes in the **Your order/requests** window. For the convenience of tracking your RFS quotes, you can setting a filter in a window, for example, by **Floor** and place the window on a separate tab (RFS). From the window of your order/requests you can change the quote via the context menu item **Add/ Change quotes**.

Provider can delete their quotes - more details see section 6.6.4.1.

Provider quotes are automatically removed by the system when closing the liquidity stream.

6.6.4.1. Cancellation of provider quotes

A provider can delete its quotes in a stream in several ways:

- from **RFS (active streams)** window by the button of the local toolbar ;
- from **RFS (active streams)** window via the context menu item **Cancel quotes**;
- from **Your orders/requests** window via the context menu item **Cancel**.

Quotes are canceled from a special window in which quotes selection parameters for cancel are set:

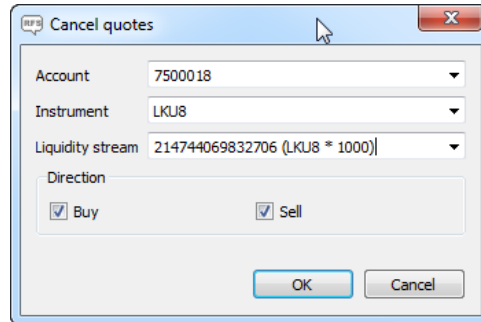

Fig. 6.65. Cancellation of provider quotes

Tab. 6.34. Quotes selection parameters for cancel

Parameter	Details
Account	The client code whose quotes will be deleted This field is required. The value can be selected from the drop-down list.
Instrument	Instrument short code. The value can be selected from the drop-down list. If the instrument code is specified, then all quotes for this instrument code set on behalf of the selected client will be deleted (Account field). If the instrument code is not specified, then orders for all instrument codes set on behalf of the selected client will be deleted.
Liquidity stream	Liquidity stream identifier. The value can be selected from the drop-down list. If a liquidity stream is specified, quotes will be deleted only within this stream. If the liquidity stream is not specified, then quotes will be deleted for all liquidity stream taking into account the remaining sampling parameters for deletion.
Direction	Direction of deleted quotes (one of the directions must be selected necessarily): <ul style="list-style-type: none"> • Buy - only buy quotes will be deleted • Sell - only sell quotes will be deleted

The client code and the direction of quotes are mandatory parameters. The rest parameters are optional - they can be specified or skipped, which will determine the result of selecting the group of deleted quotes.

The cancellation procedure is started by the **OK** button. Pressing **Cancel** button closes the parameters window without deleting quotes from the system.

When cancellation the provider quotes, a confirmation message: "Are you sure you want to cancel quotes?" appears on the screen. Press **Yes** for deleting a selected quotes, or **No** for stopping operation of cancellation.

6.6.5. Make a trade

Looking through its liquidity stream, a liquidity consumer cannot see all offers from providers. He sees only the best price to buy and sell, and if it suits him, he can accept this offer.

The liquidity consumer put matching order to the trading system with the principle of execution of 'Fill or Kill'. Such a quote can be reduced to a trade only in its entirety - for the entire volume of the instrument declared in the liquidity stream.

You can answer the provider's offer from the **RFS (active streams)** window as follows:

- by the button of the local toolbar , previously setting the cursor on the line with the needed stream;
- via the context menu item **Accept quote**, open on line with the needed stream.

The context menu item **Accept quote** has a submenu consisting of two commands: **Sell (accept purchase)** and **Buy (accept sale)**. The availability of these sub-items of the menu depends on the direction of the quotes-offers in the stream. If there is a quote of only one direction, only one of the points will be active. If there is a two-way offer, both menu items will be available. The liquidity consumer chooses the operation of interest to him.

A confirmation message: "*Do you really want to sell/buy at a price ... ?*", is displayed on the screen before putting quote to the trading system. An affirmative answer to this request initiates the process of submitting a matching quote.

If the provider quote is with auto-confirmation, the trade will be made automatically without asking for any confirmation. Two records (row) for this trade will appear in the table **Your trades/requests**. The status of these trades will be **Trade completed**. The row with the liquidity stream will disappear from the **RFS (active streams)** window.

If the provider quote is without auto-confirmation, then an additional iteration is added to the process of making trade - confirmation from the provider. A notification is sent to the provider in the form of a pop-up message in the tray and in the window **Errors and notifications**:

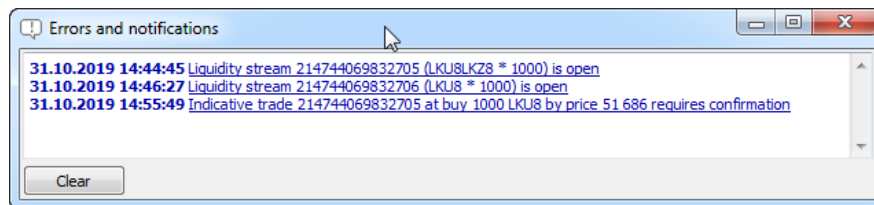

Fig. 6.66. Notification to the provider about the need to confirm the indicative trade

The text of the message is a hyperlink, by clicking on which the provider can immediately confirm the indicative trade.

You can confirm the indicative trade from the **Your trades/requests** window via the context menu item **Confirm**, previously setting the cursor on the line with the needed indicative trade (trade in status **Waiting**).

When confirmation of indicative trade by liquidity consumer, a confirmation message : "*Are you sure you want to confirm the indicative trade at a price ... ?*" Press **Yes** for make trade, or **No** - the trade is canceled, the provider's quote is deleted from the trading system, the liquidity stream remains in an active state.

You can check the **Do not show next time** checkbox to disable the confirmation message.

You can specify the confirmation message settings via the **Confirmation when RFS liquidity streams managing** option in the **Settings/ Terminal settings** window, the **Main** section, **Confirmations** tab. If the option is set, confirmation will be requested. If the option is not set, then confirmation will not be requested.

When a trade is completed, the row with this liquidity stream disappears from the **RFS (active streams)** window, and the status of such trade in the **Your trades/requests** window will be **Trade completed**.

6.6.6. Liquidity stream closing

Liquidity stream closing can occur in several ways:

- if liquidity consumer does not have enough funds;

- if trade completed - the stream closes automatically;
- automatic closing at the end of the stream lifetime. The stream duration is set by the liquidity consumer at its opening. By default, the stream duration is determined by the trading session - at its end, the stream closes;
- at the liquidity consumer request. LC can close only its own liquidity streams. Streams that are open from own login and from other logins of LC clients belong to own. You can close the stream using the button on the local toolbar  or via the context menu item **Stop auction**.

When the liquidity stream closes (the reason does not matter), all quotes set within this stream are deleted from the trading system.

When forcibly closing the liquidity stream, a confirmation message: *"Are you sure you want to stop this auction?"*, appears on the screen. Press **Yes** to stop auction, a row with this stream will disappear from the **RFS (active streams)** window, or **No** to cancel – the stream will not be close.

You can check the **Do not show next time** checkbox to disable the confirmation message.

You can specify the stream closing confirmation message settings via the **Confirmation when RFS liquidity streams managing** option in the **Settings/ Terminal settings** window, the **Main** section, **Confirmations** tab. If the option is set, confirmation will be requested. If the option is not set, then confirmation will not be requested.

Attention, please! Cancellation of confirmation will apply to all operations with liquidity streams.

6.7. Administrator and Trading System's messages

During the trading session, the system sends various information messages (about closing a trading session, etc.), error messages and trading administrator's messages.

The messages from the trading system are displayed in the status bar (see section 5.5).

Also, for some messages the 3-minutes tray bar pop-up warnings (see section 10.1) option can be enabled. To enable the semi-transparent warnings option you should use the Growl tool.

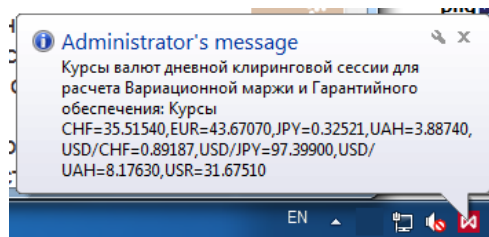

Fig. 6.67. New trading system/Administrator's message

Messages of different types are indicated in different ways and displayed in different screen areas:

- Administrator's messages - see section 6.7.1;
- error messages - see section 6.7.2;
- transaction error messages - see section 6.7.3.

6.7.1. Administrator's messages

The messages sent by the Administrator during the current connection session are stored in the **Administrator's messages** window. The window can be opened by the following ways:

- via the **Trading/ Administrator's messages** main menu item;

- by pressing the **Ctrl+Alt+M** key combination;
- via the  icon in the status bar.

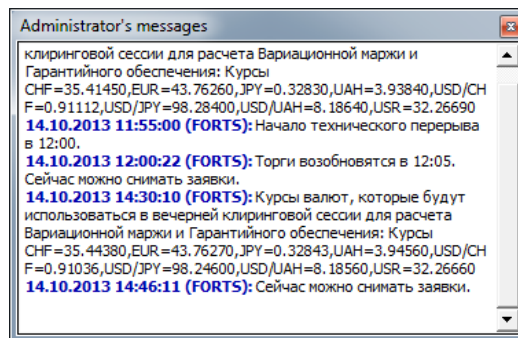



Fig. 6.68. Administrator's messages

The Administrator's messages may contain hyper-links which can be found anywhere in the message body. There may be more than one hyper-link in each message, divided with commas. Below is an example of a message with such hyper-link:

05.10.2016 14:09:45 (SPECTRA): Напоминаем, что в вечернюю клиринговую сессию 3 октября 2016 вступает в силу новая редакция Тарифов Срочного рынка. Подробнее: <http://moex.com/n13785/?nt=112>

Fig. 6.69. A system message which contains a hyper-link



For the Administrator's messages, the 3-minutes tray bar pop-up warnings (see section 10.1) option can be enabled. To enable the semi-transparent warnings option you should use the Growl tool.

When a new message from Administrator has been received, the icon  appears in the status bar until you open the **Administrator's messages** window by pressing this icon with the left mouse button. After that, the exclamation mark from the icon  will disappear.

The message window which has been opened by clicking the  icon cannot be pinned to the workspace window and to other windows. Also, this window will not be displayed in the list of open windows in the **Windows** main menu item.

If, instead, the **Administrator's messages** window has been opened via the **Trading/ Administrator's messages** main menu item, it will have the features of the standard window, i. e. it can be pinned to workspace window and other windows, also, it can stay open and be visible in the list of the open windows in the **Windows** main menu item.

6.7.2. Errors and notifications

The error messages received during the current connection session are stored in the **Errors and notifications** window – fig. 6.70. When a error occurs (for example, a connection error), the  icon appears in the status bar. The  icon remains in the status bar if at least one error message has been received during the current connection session.

The window can be opened by the following ways:

- via the **Trading/ Errors and notifications** main menu item;
- via the  icon in the status bar.

The **Errors and notifications** window contains the complete list of errors occurred during the current connection session including the date and time of each error along with the error description. To clear the errors list press **Clear**.

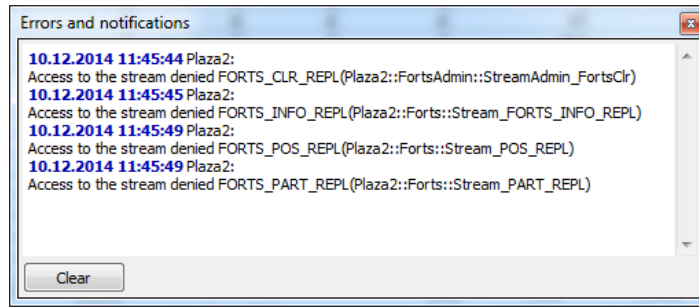

Fig. 6.70. Errors and notifications window

Also, for the error messages, the 3-minutes tray bar pop-up warnings (see section 10.1) option can be enabled. To enable the semi-transparent warnings option you should use the Growl tool.

6.7.3. Transaction error messages

If a transaction error (for example, when an order is adding into the trading system), occurs, the appropriate message will be displayed in the **Messages** window - see section 6.2.13.

Also, for the transaction error messages, the 3-minutes tray bar pop-up warnings (see section 10.1) option can be enabled. To enable the semi-transparent warnings option you should use the Growl tool.

Chapter 7. Options

This chapter overviews details of the following boards and operations:

- options board;
- exercise options;
- volatility curve;
- options calculator.

7.1. Options board

The **Options board** window contains information for all options in the current trading session. The information in the **Options board** window is mostly the same as it in the **Financial instruments** window (see section 6.1.2); the only difference is the view mode, which is more convenient for working with options.

You can open the window by the following methods:

- via the **Tables/ Options board** main menu item;
- via the **Open options board** context menu item, opened from the **Financial instruments** window. Please note that this context menu item is available only if the context menu has opened from a line containing an option record..

On the options board, the instruments are arranged according to their underlying assets.

The **Options board** window (fig. 7.1) displays the sell and buy orders for the same underlying assets dividing into different option contracts. Such arranging allows you to make compositions of strikes and options of different types .

Every record in the **Options board** table belongs to a particular option contract. The records contain information on the best put and call contracts for the same underlying asset; the records are arranged according to their strikes. The table columns contain the option contracts parameters– see tab. 7.1.



The instrument list in the **Options board** window can be filtered according to your needs. You can specify the filtering settings via the **Window settings/ Filters** menu item – see section 7.1.1. For easier access, the filtering settings for underlying contract ID and exercise date are available in the instrument panel of window **Options board**.



Also, you can add/remove instruments in the instrument list via the **Window settings/ Instruments** context menu item – see section 7.1.2.

You can use the contextual search option to find a particular account in the list; to do this, enter a sequence of characters in the appropriate field above and press (see section 5.10.3). Contextual search can be activated by pressing **Ctrl+F**.

Double-clicking the left mouse button on a selected instrument opens the Order-book window for this instrument(see section 6.2.2). Also, you can open the Order-book window via the **Open Order-book** context menu item.

You can specify different nesting depth for the left and right parts of the window:

-  - minimize group of records. All records of all levels will be minimized automatically;
-  - maximize group of records. The nested levels will not be maximized automatically: you should manually maximize every nested level.

Clicking the  or  button (in the first column header) allows to maximize or minimize all groups at once for all underlying assets. Button changes its appearance automatically.

The screenshot shows a window titled "Options board" with a dropdown menu set to "Black-Scholes model". Below the menu is a table with columns: Instrument: call, Buy: call, Sell: call, Price: call, Op. pos.: call, Theoretical price, Volatility, %: call, Strike, Volatility, %: put, and Theoretic. The main table has columns: Und. contract, Name, Buy, Sell, Price, Board, Open pos., CS volatility, and Theoretic. The first row is expanded to show "Options : SIZ7 - okt 19, 2017 (42nd week)..." with values: Buy 58 455, Sell 58 467, Price 58 467, Board Options, Open pos. 740198, CS volatility 8,84. Subsequent rows list various option contracts (e.g., SI55250BJ7, SI55500BJ7, etc.) with their respective Buy, Sell, Price, Board, Open pos., and CS volatility values.

Fig. 7.1. Options board

Tab. 7.1. Parameters in the Options board tab

Parameter	Details
Instrument: put	put: Instrument short code.
Code: put	put: Instrument code.
Buy: put	put: Best buy order price.
Sell: put	put: Best sell order price.
Price: put	put: Price of closing trade.
Op. pos.: put	put: Current number of open positions.
For sell: put	put: Quantity in the best sell order.
For buy: put	put: Quantity in the best buy order.
Trend: put	put: Price fluctuation trend (difference between prices of two last trades).
Q-ty: put	put: Amount in the last trade
Last: put	put: Date and time of last trade.
Min price: put	put: Minimum price.
Max price: put	put: Maximum price.
Avg.: put	put: Average price.
Prev. price: put	put: Settling price of previous session.
Trades: put	put: Amount of trades.
Volume: put	put: Total number of lots in trades.
Turnover: put	put: Total trades volume.
Changed: put	put: Date and time of record modification.
Amount to sell: put	put: Amount of sell orders.
Amount for selling: put	put: Amount in sell orders (in contracts).
Amount to buy: put	put: Amount of buy orders.
Amount for buying: put	put: Amount in buy orders (in contracts).
Opening price: put	put: Opening price.

Parameter	Details
Closing price: put	put : Closing price.
Th. price: put	put : Option theoretical price.
Volatility: put	put : Option volatility.
Delta: put	put : Rate of option premium change relative to underlying asset price.
Gamma: put	put : Rate of option delta change if underlying asset price has changed by 1.
Vega: put	put : Rate of option delta change if volatility has changed by 1.
Theta: put	put : Rate of option delta change relative to time (till expiration): amount of money the option loses per single day.
Strike	Exercise price - a fixed price value, at which the option assets are to be bought (option call) or sold (option put) if the option owner exercises the option contract. The central strike price is marked in bold.
Delta: call	call : Rate of option premium change relative to underlying asset price change.
Gamma: call	call : Rate of option delta change if underlying asset price has changed by 1.
Vega: call	call : Rate of option delta change if volatility has changed by 1.
Theta: call	call : Rate of option delta change relative to time (till expiration): amount of money the option loses per single day.
Volatility: call	call : Option volatility.
Th. price: call	call : Option theoretical price.
Closing price: call	call : Closing price.
Opening price: call	call : Opening price.
Amount for buying: call	call : Amount in buy orders (in contracts).
Amount to buy: call	call : Amount of buy orders.
Amount for selling: call	call : Amount in sell orders (in contracts).
Amount to sell: call	call : Amount of sell orders.
Changed: call	call : Date and time of record modification.
Turnover: call	call : Total trades volume.
Volume: call	call : Total number of lots in trades.
Trades: call	call : Amount of trades.
Prev. price: call	call : Settling price of previous session.
Avg.: call	call : Average price.
Max price: call	call : Maximum price.
Min price: call	call : Minimum price.
Last: call	call : Date and time of last trade.
Q-ty: call	call : Amount in the last trade
Trend: call	call : Price fluctuation trend (difference between prices of two last trades).
For buy: call	call : Quantity in the best buy order.
For sell: call	call : Quantity in the best sell order.
Op. pos.: call	call : Current number of open positions.
Price: call	call : Price of closing trade.
Sell: call	call : Best sell order price.
Buy: call	call : Best buy order price.

Parameter	Details
Code: call	call: Instrument code call .
Instrument: call	call: Instrument short code call .
Group of options	
Floor	Floor short name.
Und. contract board	Underlying contract board.
Und. contract	Underlying contract instrument.
Name	Options group name.
Buy	Price of the best buy order for underlying contract for set of options.
Sell	Price of the best sell order for underlying contract for set of options.
Price	Best price of underlying contract for set of options.
Board	Options board.
Open pos.	Current amount of open positions.
CS volatility	Volatility of central strike for series of options.
UA name	Instrument underlying asset name.
Underlying asset	Instrument underlying asset code.

You can specify set and order of parameters according to your needs (**Window settings/ Columns/ Columns** - option instrument parameters, **Window settings/ Columns/ Options** - underlying asset parameters) - see section 11.3.

You can change width of the line with underlying asset parameters using the **Window settings/ Columns/ Options** menu item. To change width, click the field border with the left mouse button, drag it to a new area and then release the mouse button. The bottom of the page contains the line layout preview.

The **Options board** window allows to highlight different fields with different colour schemes according to the current market conditions (best buy, best sell, the last trade price change trend). You can do it via the **Window settings/ View** context menu item – see section 11.2.

To switch off the colour highlighting you should switch off every option in the **Window settings: Highlight buy-sell** and **Highlight last trade direction** context menu item of the **View** section.

However, the colour indication for price cells (green for price growth/red for price fall) cannot be switched off.

You can configure the widget to select the option pricing model that will be displayed in the upper right corner of the window. You can do it via the **Window settings** context menu item (see section 11.1), setting the **Show in toolbar** option on the **Main** tab. By default, the widget is not displayed in the window. The widget of option pricing model allows to choose the Black-Scholes or Bachelier (support for negative prices) model for calculations. If the widget is not displayed, then you can change the option pricing model via the **Window settings** context menu item, selecting the desired model from the drop-down list in **Option pricing model** field on the **Main** tab and then clicking on the **OK** or **Apply** button.

7.1.1. Filters in the Options board window

You can specify the **Options board** window filter settings via the **Window settings** context menu item of the **Filters** section.

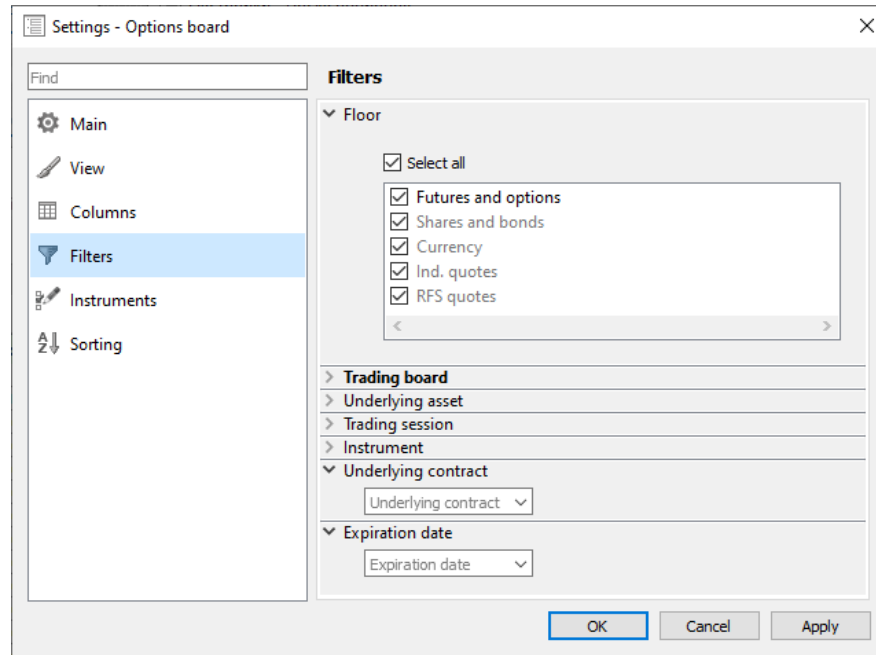

Fig. 7.2. Setting filters in the Options board window

The **Options board** window displays only the instruments subjected to the current filter settings. To select the instruments to be displayed, you should check the checkboxes next to their names in the window. To remove an instrument from the window, uncheck its checkbox

By default, the window displays all available instruments.

Attention! Please note, that filters applied in the **Filters** and **Instruments** sections (see section 7.1.2) are used together. I.e., the window contains only the instruments which meet both filters' rules.

Tab. 7.2. Filtering parameters in the Options board window

Parameters	Details
Floor	Filter by trading floor. If the Select all option is active, then the window will contain all instruments for all trading floors. If the Select all option is inactive, the window will be empty. To select the floors you need, you should select them manually by checking the appropriate checkboxes. The list of available floors depends on the settings on the Transport tab (Settings / Terminal settings) - some records in the list may remain inactive (they highlighted gray color).
Trading board	Filter by the trading board. The Select all option allows to select/deselect all option instruments from all trading boards. To select/deselect a particular instrument, you should check/uncheck the checkbox next to the instrument name.
Underlying asset	Filter by the underlying asset code. The Select all option allows to select/deselect all option instruments for all underlying assets. To select/deselect a particular instrument, you should check/uncheck the checkbox next to the instrument name.
Trading session	Filter by trading session: <ul style="list-style-type: none"> • Select all - display all available instruments; • Main trading session - display only the instruments traded in the Main trading session;

Parameters	Details
	<ul style="list-style-type: none"> • Evening trading session - display only the instruments traded in the Evening trading session; • Not traded - display only the instrument which are not currently traded.
Instrument	Filter by instruments. Can be specified in the Window settings/ Instruments section - see section 7.1.2.
Underlying contract	<p>Filter by underlying contract ID. You can select a value from the drop-down menu.</p> <p>The value <none> means that no filter will be applied, so that the list will contain all available records.</p> <p>You can specify this settings directly via the instrument panel of the window Options board.</p>
Expiration date	<p>Filter by option contract expiration date. You can select a value from the drop-down menu.</p> <p>The value <none> means that no filter will be applied, so that the list will contain all available records.</p> <p>You can specify this settings directly via the instrument panel of the window Options board.</p>

The **Select all** option allows to select/deselect all parameters at once.

To cancel filtration you can use the **Window settings** context menu item of the **Filters** section.

Filtering by instruments can be specified in the **Window settings/ Instruments** section - see section 7.1.2.

Once you close the window and then open it again, the window will be open in its default configuration, causing all your filter settings to be lost. To save your settings, you should save the current configuration as default via the **Current window/ Save by default** main menu item. This configuration becomes active even after restarting the application.

To automatically save the current configuration when you exit the terminal should install option **Save the current desktop settings befor exit (Settings/ Terminal settings/ Main/Common)**.

7.1.2. Filtering by instruments in the Options board window

In the **Options board** window, you can set filtering by the instrument structure via the **Window settings/ Instruments** context menu item.

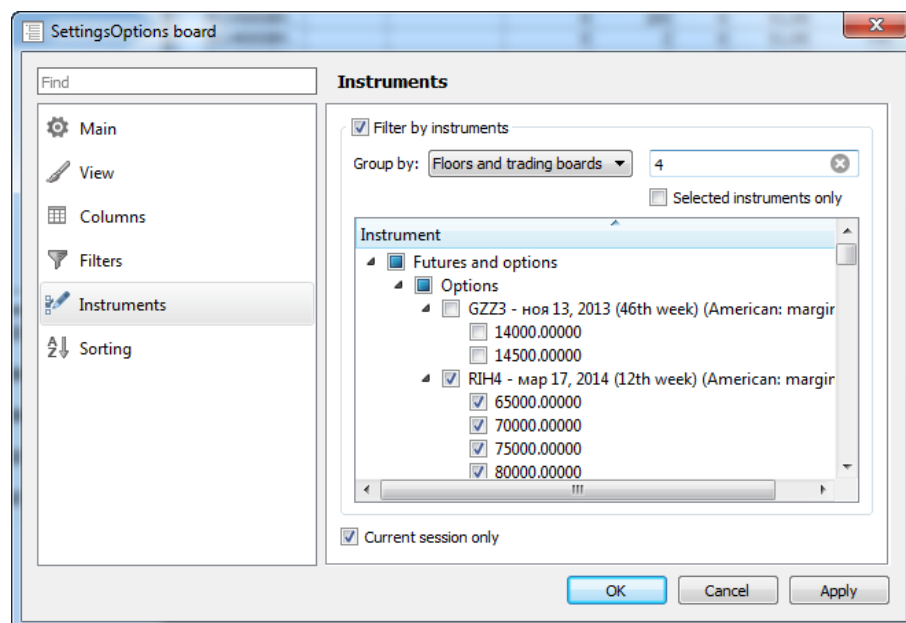

Fig. 7.3. Filtering by instruments in the Options board window

To activate the filter you should check the **Filter by instruments** checkbox. After that, you will be allowed to select instruments and their underlying assets in the list below.

You can group instruments in the list in the following ways:

- **Floors and boards** - by floors, then by boards;
- **Floors** - by floors only (boards are omitted);
- **Boards** - by boards only (floors are omitted);
- **Types** - by instrument types (indexes, options, etc.);
- **Underlying asset** - by underlying assets (floors and boards are omitted);
- **Floors and types** - by floors, then by instrument types;
- **Boards and types** - by boards, then by instrument types;
- **Floors, types, boards** - by floors, then by instrument types, then by boards;
- **<total>** - in alphabetical order (according to instrument codes).

You can search for an instrument in the list by typing its name into the contextual search field; the case-insensitive search starts immediately after entering the first symbol. The search results will display all records containing the entered symbols. To clear search results simply delete symbols from the search field.

If the **Selected instrument only** option is active, the filter list will contain only the active instruments names.

You can change the filter settings by checking/unchecking checkboxes left of each instrument name (please note, that the **Financial instruments** window contains only active instruments!). After selection is done, press **Apply** or **OK**.

To cancel filtering, simply set all instruments in the filter list as active.

The **Current session only** option allows to manage the instruments list in the filter window. If the option is active, the list will contain only the instruments traded in the current trading session. Otherwise, some expired instruments from the previous trading sessions may also be added into the list.

When a new trading instrument is added into the trading system, its visibility in the **Options board** window will depend on the filter type applied for this window. If an applied filter includes a group of instruments, then the new instrument may (or may not, if it does not belong to the group) automatically become visible and active in the **Options board** window. If the filter includes only some particular instruments, the new instrument will not be included in the list automatically, so that it will not appear in the **Options board** window until you manually change the filtering preferences.

Once you close the **Options board** window and then open it again, the window will be open in its default configuration, causing all your filter settings to be lost. To save your settings, you should save the current configuration as default via the **Current window/ Save by default** main menu item. This configuration becomes active even after restarting the application.

7.1.3. Sorting in the Options board window

Sorting by column headers is not available in this window as it may lead to breaking the order of instrument which have been sorted out by underlying assets .

The only available sorting option by columns is to arrange instrument by the **Strike** column (see section 5.10.2), in order to arrange the records in the table according to strike value inside each of options group. After the sorting by the **Strike** column has enabled, all option groups will be automatically maximized even if they had been minimized before.

The other types of sorting can be specified via the **Window settings** context menu item on the **Sorting** page - fig. 7.4. Please note, that to enable the sorting option you should enable the filtering by instruments first (see section 7.1.2). The list of option depends on the instruments covered by filters, i.e. the list will contain only the instruments according to the filtering settings. Once you change the filtering settings for instruments, the options list will change, too.

If you disabled the filtering in the window having the sorting option enabled, the **Sorting** page remains unchanged until you changes the filtering by instruments settings.

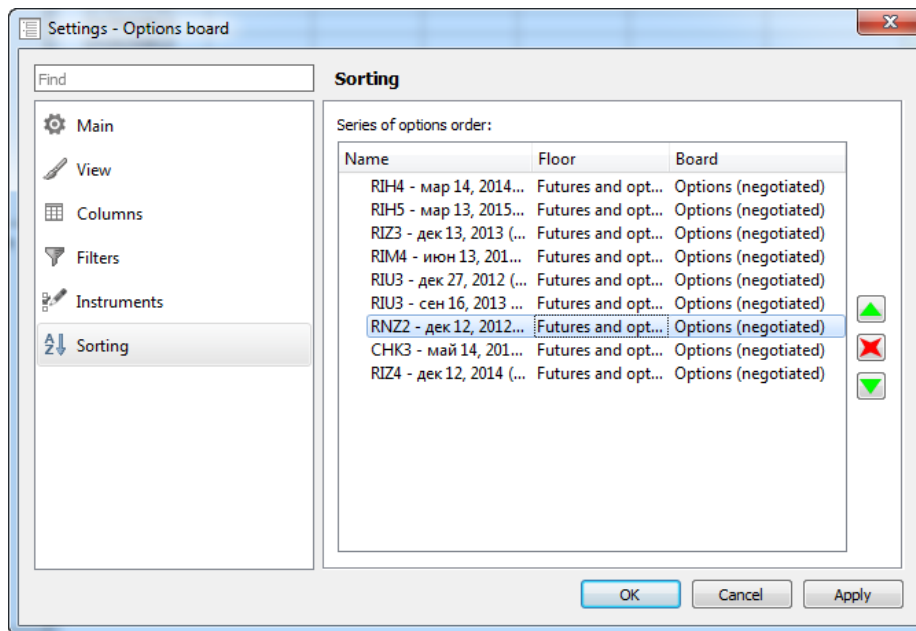





Fig. 7.4. Sorting in the Options board window

The window displays all options group selected for the **Options board** window, in the order equal to that in the sorting settings window (see fig. 7.4). Sorting in the **Options board** window is applied to the whole options group, and does not cover the nested options.

To move an options group from one position to another in the sorting settings window (fig. 7.4), you should place the mouse cursor on a line containing an option ticker and press one of the following buttons:

-  - move one position up;
-  - move one position down;
-  - hide from the table.

If you need to move more than one line at once, you should select the lines you need using the **Shift** or **Ctrl** key.

To confirm the changes, press **Apply** or **OK** button.

7.1.4. Context menu in the Options board window

The standard context menu items are described in Chapter 11. Below you will find description for the particular **Options board** window context menu items. There are:

- **Add order at <instrument code>** – opens the order adding window for the selected instrument (see section 6.2.3.1);
- **Request to NCC for <instrument code>** – opens the request to NCC window for the selected instrument (see section 6.2.5);
- **Open Order-book** (the default action) – opens the **Order-book** window for the selected instrument. The window can be also opened by double-clicking an instrument with the left mouse button (see section 6.2.2);
- **Open chart** – opens the **Tech. analysis** window, containing graphical chart for the selected instrument;
- **Information** - opens the **Information** window, containing information on the selected instrument;
- **Add volatility curve** - adds the volatility curve chart into a separate window (see section 7.3);

Before performing any action, you should select an instrument by placing the mouse cursor on the appropriate line. The action will be applied to the selected instrument.

7.2. Options exercising

When exercising an option, both parties (seller and buyer) fulfil their obligations for the option contract; due to that, the new positions will open on the futures market, by the price equal to the exercising option strike. The exercising is performed during a clearing session.

Options are exercised in accordance with the orders added before. The exercise orders can be added via the trading terminal, during a trading session and also 10 minutes before it ends.

Options can be exercised in two modes:

- *anticipated* - according to the exercise order, which can be added by the client at any time during a trading session. The orders are accepted during the trading sessions and exercised during the clearing sessions (twice a day);
- *automatic* - on the day of the option expiration. Every in the money option margined by a value equal or greater than the minimum tick size will be exercised automatically on the day of its expiration. This exercise rule prevails the clients rules.

7.2.1. Options exercise orders

Options are exercised in accordance with the orders added before. The exercise orders can be added via the trading terminal, during a trading session and also 10 minutes before it ends.

You can add an option exercise order in the **Positions/ requests** window (the **Trading/ (Positions/ requests** main menu item) - see section 6.1.6) via the **Exercise option context menu item** or by pressing the  button on the local instrument panel in the **Positions/ requests** window. The context menu item is available only if the context menu opens from an option record.

Before adding the exercise order, you should fill in the special form in the **Exercise option** window:

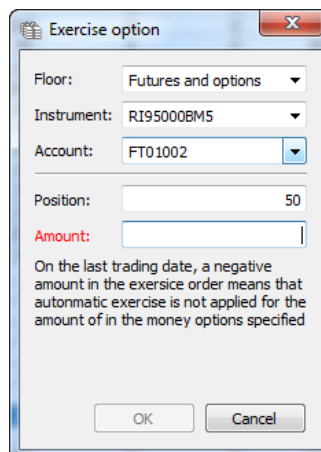

Fig. 7.5. Exercise option

The form fields are filled in with parameters of the option under the cursor:

- **Floor** - trading floor for the selected instrument;
- **Instrument** - instrument code;
- **Account** - client account number;
- **Position** - the current instrument position for the client account (this field is non-editable);

- **Amount** - number of position to exercise. The number cannot be greater than the real number of positions on the account. In order to cancel the automatic exercise you should add the option exercise request with the **Amount** field containing a negative number on the option expiration day. Therefore, the specified number of in-the-money option contracts will not exercise automatically.

In order to edit the values in the fields, you can enter new values manually, or select them in the drop-down lists. Once you have changed a value in the **Instrument** or **Account** field, the value in the **Position field** will also change in accordance with the newly added ones.

Press **OK** to add the order into the trading system. After you pressed **OK**, the system will ask you: "Are you sure you want to exercise the option?". Press **Yes** to confirm, or **No** to cancel the exercising and return to the order adding window.

All the option exercise orders are displayed in the **Positions/ requests** window. If there is an exercise order added for any instrument, the **Order, Exercise, Date** and **Int. clearing** fields will display the order details.

7.2.2. Options exercising rules

Every option requires a corresponding exercising rule, otherwise it will not be exercised automatically. You can create a single automatic exercising rule for all options.

There are two types of exercising rules available:

- *'Automatically generate option exercise orders for the in the money option contracts by a value equal or greater than the minimum tick size'; this option is set up by the trading administrator solely. You cannot set it changing the trading terminal settings.*
- *'Reject exercise orders for the out of the money options'*. This rule can be set by:
 - the chief trader of CF – the rule then will be applied to every account of the CF;
 - the trader of BF – the rule then will be applied to every account of the BF.

Both of these rules can be added at any time (for example, 1 or 2 days prior), but:

- the automatic order generation rule will be active during the evening clearing session only, on the option expiration day only;
- the orders rejection rule will be active at every clearing session, until the rule will be removed.

The rules are applied via the **automatic generation** (see section 7.2.2.1) or via the **option exercise orders** removing (see section 7.2.2.2) actions, during the clearing sessions.

Any rule can be attached to a particular Underlying contract, or to all Underlying contract at once. Once set, the rule will be active until being canceled.

The rules can be set in the **Management** window (**Management/ Management** main menu item) in the **Exercise rules** tab - for details see section 8.8.

7.2.2.1. Automatic order generation algorithm

The rule *'Automatically generate option exercise orders for the in the money option contracts by a value equal or greater than the minimum tick size'*.

On the option expiration day, in the clearing session, the following exercise orders will be generated:

- for the **PUT** options, when $Strike > Q + min_step$, where

Strike - option exercise price;

Q - underlying futures contract settlement price

min_step - minimum tick size

- for the **CALL** options, where $\text{Strike} < Q + \text{min_step}$.

7.2.2.2. Option exercise orders removing algorithm

When the rule 'Reject exercise orders for the out of the money options' is set, then the following orders will be rejected during the clearing sessions:

- for the **PUT** options, when $\text{Strike} \leq Q$;
- for the **CALL** options, when $\text{Strike} \geq Q$.

7.3. Volatility curve

The volatility curve is added for the put and call options with the same underlying futures and the same expiration date.

You can add the volatility curve using the **Add volatility curve** context menu item in the following windows:

- **Financial instruments** - if an futures or option instrument is selected;
- **Options board**;
- **Your orders/requets** - if an futures or option instrument is selected;
- **Your trades/requets** and **All trades/requets** - if an futures or option instrument is selected;
- **Market maker obligations for options**;
- **Options calculator** - in real or virtual portfolio area, if an futures or option instrument is selected;
- **Information** - if this window was opened for futures or option instrument.

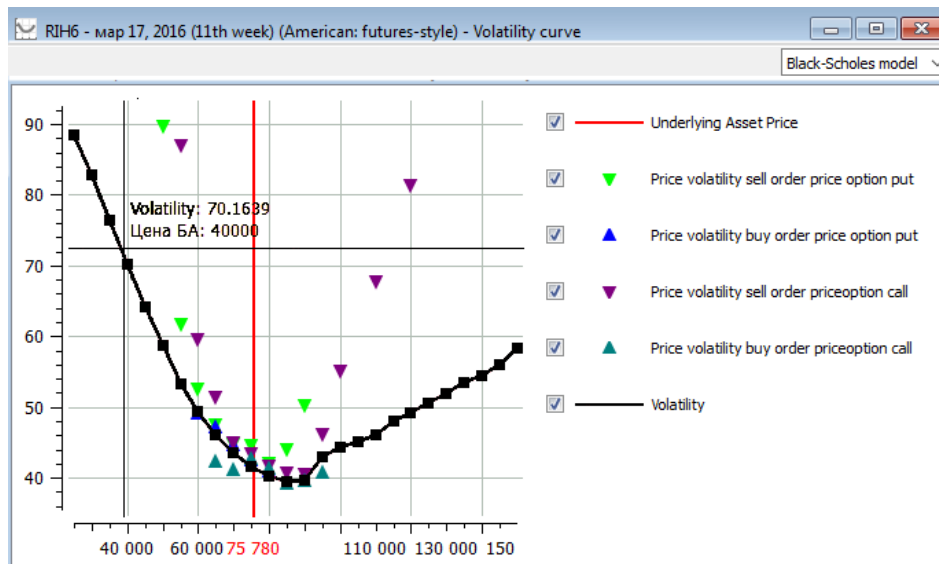

Fig. 7.6. Volatility curve

Strike values are plotted along the horizontal axis, while volatility percentage is plotted along the vertical axis.

Apart from volatility curve, the chart also contains volatility data for best buy and sell prices for options put and options call for strikes. Note, that the best price values may deeply vary from theoretical option price, and not be displayed on chart. To avoid this, you can widen volatility band using the option **Expand volatility band to ... percent by central strike volatility** of context menu **Window settings**. The default volatility band value is 20%.

There is a legend right of the chart, which contains descriptions of all objects displayed on the chart. You can select visibility of each object using the appropriate checkbox next to the object description:

- On - the object is visible;
- Off - the object is hidden.

When you points the curve with the mouse cursor, a color crosshair appears there along with the volatility values and the BA price. The values are discrete, so that they may not match the axes coordinated. The color of crosshair displayed on chart depends on the object which is the closest to the current point.

Every time the volatility value changes, the volatility curve will be redrawn.

The widget to select the option pricing model is displayed in the upper right corner of the window. You can configure it via the **Window settings** context menu item (see section 11.1), on/off the **Show in toolbar** option on the **Main** tab. By default, the widget is displayed in the window. The widget of option pricing model allows to choose the Black-Scholes or Bachelier (support for negative prices) model for calculations. If the widget is not displayed, then you can change the option pricing model via the **Window settings** context menu item, selecting the desired model from the drop-down list in **Option pricing model** field on the **Main** tab and then clicking on the **OK** or **Apply** button.

7.4. Options calculator

The Options calculator allows to analyze the option strategy.

The **Options calculator** window can be opened via the **Trading/ Options calculator** main menu item.

The option calculator window can be opened for a particular underlying asset from the drop-down list, which evokes once you put the mouse cursor over the **Options calculator** main menu item. There is a separate window for each underlying asset. You can open more than one **Options calculator** window at the same time.

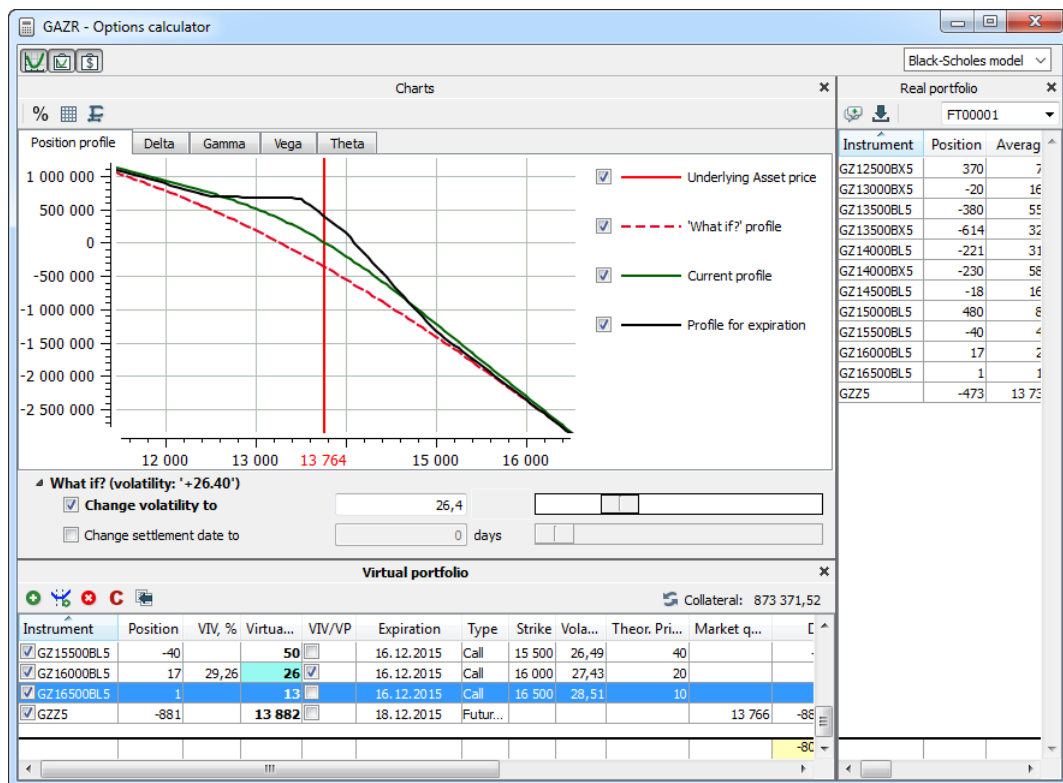





Fig. 7.7. Options calculator

The **Options calculator** window contains the following data:

- **real portfolio** - the current positions for options and futures on the current account (see section 7.4.2);
- **virtual portfolio** – forecast for instrument portfolio change (see section 7.4.3);

- **charts** - graphical charts for position profile and option greeks (see section 7.4.4);

You can hide any area:

- by pressing a little cross button in the upper-right corner of the area;
- by pressing the appropriate button on the main instrument panel of the window **Options calculator** ( - charts,  - virtual portfolio,  - real portfolio);
- via the appropriate context menu item - **Charts**, **Virtual portfolio**, **Real portfolio**. The context menu can be evoked from any point of the window **Option calculator**.







To show the hidden area you should either press the appropriate button in the instrument panel or click the appropriate context menu item.









All the main commands can be run either through the context menu items (there are each context menu for every area) or by pressing the appropriate buttons in the instrument panel (see section 7.4.1). Apart from the main instrument panel, every area has its local instrument panel providing access to the appropriate commands).

You can configure the widget to select the option pricing model that will be displayed in the upper right corner of the window. You can do it via the **Window settings** context menu item (see section 11.1), setting the **Show in toolbar** option on the **Main** tab. By default, the widget is not displayed in the window. The widget of option pricing model allows to choose the Black-Scholes or Bachelier (support for negative prices) model for calculations. If the widget is not displayed, then you can change the option pricing model via the **Window settings** context menu item, selecting the desired model from the drop-down list in **Option pricing model** field on the **Main** tab and then clicking on the **OK** or **Apply** button.

7.4.1. Toolbar of Option calculator

Tab. 7.3. Toolbar of Option calculator

Icon	Command	Details
Main		
	Charts (the context menu can be evoked from any point of the window Option calculator)	Hide/show the area Charts
	Virtual portfolio (the context menu can be evoked from any point of the window Option calculator)	Hide/show the area Virtual portfolio .
	Real portfolio (the context menu can be evoked from any point of the window Option calculator)	Hide/show the area Real portfolio .
Charts		
	X-axis displays percentage	Switch H-scale values display mode for all charts
	Small grid	Switches grid mode from coarse to dense and back.
	Auto scaling	If a chart scale has been occasionally changed, the automatic scale button will put the chart back into visible area of the window. If the button is already in the pressed state, it will be automatically released once you start to change a chart scale.
Virtual portfolio		

Icon	Command	Details
	Add position (context menu should be opened in the virtual portfolio area)	Open a window for adding new position into virtual portfolio - see section 7.4.3.
	Add strategy (context menu should be opened in the virtual portfolio area)	Add strategy to virtual portfolio.
	Remove position (context menu should be opened in the virtual portfolio area)	Remove selected positions of virtual portfolio - see section 7.4.3.
	Clear (context menu should be opened in the virtual portfolio area)	Delete virtual portfolio data.
	Import data (context menu should be opened in the virtual portfolio area)	Load data from text csv-file into virtual portfolio - see section 7.4.3.1, deleting all data stored in your virtual portfolio.
	Recalculate collateral (context menu should be opened in the virtual portfolio area)	Recalculate collateral for virtual portfolio - see section 7.4.3.6.
Real portfolio		
	Arrange pool of orders (context menu should be opened in the real portfolio area)	Add orders on differences between real portfolio positions and virtual portfolio positions - see section 7.4.2.1.
	Add to virtual portfolio (context menu should be opened in the real portfolio area)	Load real portfolio data into virtual portfolio, deleting all data stored in your virtual portfolio.

7.4.2. Real portfolio

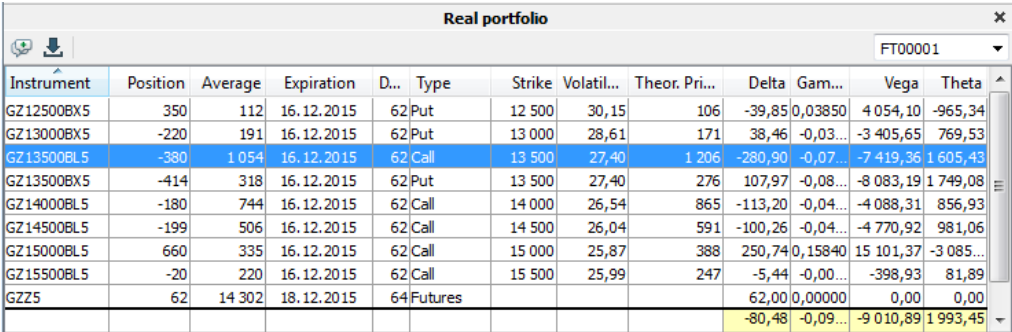

Instrument	Position	Average	Expiration	D...	Type	Strike	Volatil...	Theor. Pri...	Delta	Gam...	Vega	Theta
GZ12500BX5	350	112	16.12.2015	62	Put	12 500	30,15	106	-39,85	0,03850	4 054,10	-965,34
GZ13000BX5	-220	191	16.12.2015	62	Put	13 000	28,61	171	38,46	-0,03...	-3 405,65	769,53
GZ13500BL5	-380	1 054	16.12.2015	62	Call	13 500	27,40	1 206	-280,90	-0,07...	-7 419,36	1 605,43
GZ13500BX5	-414	318	16.12.2015	62	Put	13 500	27,40	276	107,97	-0,08...	-8 083,19	1 749,08
GZ14000BL5	-180	744	16.12.2015	62	Call	14 000	26,54	865	-113,20	-0,04...	-4 088,31	856,93
GZ14500BL5	-199	506	16.12.2015	62	Call	14 500	26,04	591	-100,26	-0,04...	-4 770,92	981,06
GZ15000BL5	660	335	16.12.2015	62	Call	15 000	25,87	388	250,74	0,15840	15 101,37	-3 085...
GZ15500BL5	-20	220	16.12.2015	62	Call	15 500	25,99	247	-5,44	-0,00...	-398,93	81,89
GZZ5	62	14 302	18.12.2015	64	Futures				62,00	0,00000	0,00	0,00
									-80,48	-0,09...	-9 010,89	1 993,45

Fig. 7.8. Options calculator. Real portfolio

The section **Real portfolio** displays data in a single client account. The client account can be selected from a drop-down list in the upper-right corner of the window. If you need to view data in your another account, you should change the account number in the current window or simply open one more Options calculator window.

The last lines in the **Real portfolio** contain the total values for the columns; these lines are highlighted in yellow. The output string in the portfolio table displays greeks values only for active instruments.

You can specify set and order of parameters according to your needs via the **Window settings** context menu item of the **Columns** tab for **Real portfolio** (see section 11.3).

Tab. 7.4. Parameters in Real portfolio area

Parameter	Details
Instrument	Instrument short code.

Parameter	Details
Position	Current position.
Average	Average-weighted position price.
Expiration	Instrument expiration date.
Days before expiration date	Number of days before instrument expiration date.
Type	Instrument type: <ul style="list-style-type: none"> • futures; • option Call; • option Put.
Strike	Option exercise price.
Volatility	Option volatility.
Theor. price	Option theoretical price.
Delta	Rate of option premium change relative to underlying asset price.
Gamma	Rate of option delta change if underlying asset price has changed by 1.
Vega	Rate of option delta change if volatility has changed by 1.
Theta	Rate of option delta change relative to time (till expiration): amount of money the option loses per single day.

You can manage records in real portfolio using buttons in the instrument panel (see section 7.4.1) or context menu items (the context menu should be opened from the real portfolio area). Apart from executing the standard command **Window settings** (see Chapter 11), the context menu items allow to make the following:

- **Chart, Virtual portfolio, Real portfolio** - these menu items allow to show or hide the appropriate area of the window;
- **Undo (Ctrl+Z)** - undo the latest action in virtual portfolio;
- **Redo (Ctrl+Y)** - redo the latest action in virtual portfolio;
- **Add position** - open the window to add a position into virtual portfolio (see section 7.4.3.2);
- **Add strategy** - open the window to add a strategy into virtual portfolio (see section 7.4.3.3);
- **Remove position** - remove selected records from virtual portfolio (see section 7.4.3.4);
- **Clear** - remove all records from virtual portfolio (see section 7.4.3.4);
- **Import data** - import data from file (see section 7.4.3.1);
- **Add order** - opens a form to add order on the selected instrument (see section 6.2.3.1);
- **Request to NCC for <instrument code>** – opens the request to NCC window for the selected instrument (see section 6.2.5);
- **Open all trades** - open the window **All trades** on the selected instrument (see section 6.3.1);
- **Open Order-book** - open the order-book window on the selected instrument (see section 6.2.2). This command is set as the default, i.e. it can be run by double clicking the selected instrument with the left mouse button;
- **Add chart** - open a new window Tech. analysis and add both series and **Volume** index charts on the selected instrument (see section 9.2);
- **Add volatility curve** - add volatility curve chart in a dedicated window (see section 7.3);
- **Information** - open the window **Information** on the selected instrument (see section 6.1.1).

7.4.2.1. Generating real portfolio data based on virtual portfolio data

The Options calculator allows to compare the real portfolio data with the virtual portfolio data in order to check if there is any difference between orders that each portfolio contains. As a result, there will be generated a pool of orders which are absent in the real portfolio.

You can generate the pool of orders absent in the real portfolio by the following methods:

- by pressing the button in the local instrument panel ;
- by item **Arrange pool of orders** of context menu opened in real portfolio area.

The list of absent orders is displayed in a separate window **Postponed orders**:

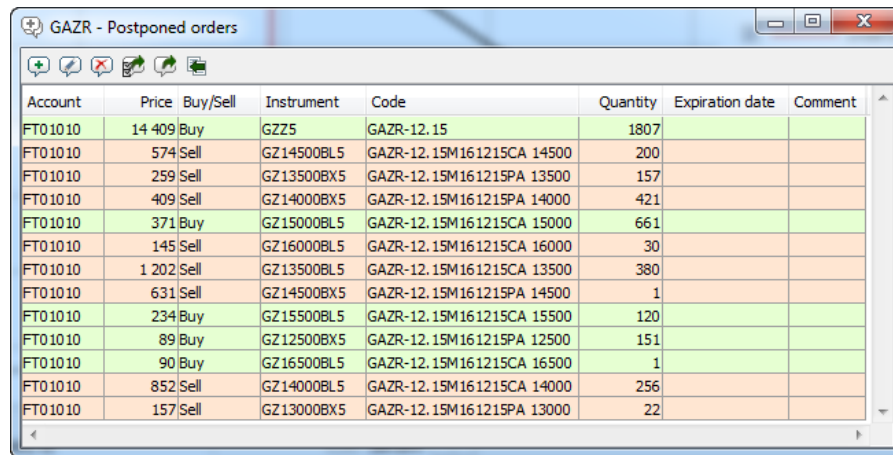

Account	Price	Buy/Sell	Instrument	Code	Quantity	Expiration date	Comment
FT01010	14 409	Buy	GZZ5	GAZR-12.15	1807		
FT01010	574	Sell	GZ14500BL5	GAZR-12.15M161215CA 14500	200		
FT01010	259	Sell	GZ13500BX5	GAZR-12.15M161215PA 13500	157		
FT01010	409	Sell	GZ14000BX5	GAZR-12.15M161215PA 14000	421		
FT01010	371	Buy	GZ15000BL5	GAZR-12.15M161215CA 15000	661		
FT01010	145	Sell	GZ16000BL5	GAZR-12.15M161215CA 16000	30		
FT01010	1 202	Sell	GZ13500BL5	GAZR-12.15M161215CA 13500	380		
FT01010	631	Sell	GZ14500BX5	GAZR-12.15M161215PA 14500	1		
FT01010	234	Buy	GZ15500BL5	GAZR-12.15M161215CA 15500	120		
FT01010	89	Buy	GZ12500BX5	GAZR-12.15M161215PA 12500	151		
FT01010	90	Buy	GZ16500BL5	GAZR-12.15M161215CA 16500	1		
FT01010	852	Sell	GZ14000BL5	GAZR-12.15M161215CA 14000	256		
FT01010	157	Sell	GZ13000BX5	GAZR-12.15M161215PA 13000	22		

Fig. 7.9. Postponed orders

For more details about the window **Postponed orders** and ways of managing it see section 6.2.8.

Opened from the **Options calculator**, the window **Postponed orders** will contain orders for the underlying asset equal to that the Options calculator has been opened for. The underlying asset code is displayed in the header of the window **Postponed orders**.

Then, the pool of orders can be edited and added into the real portfolio (the orders are added into the Trading system) by pressing the button of the local instrument panel  **Send orders**.

7.4.3. Virtual portfolio

The **Virtual portfolio** section allows to get forecast data for a possible portfolio change (see fig. 7.7).

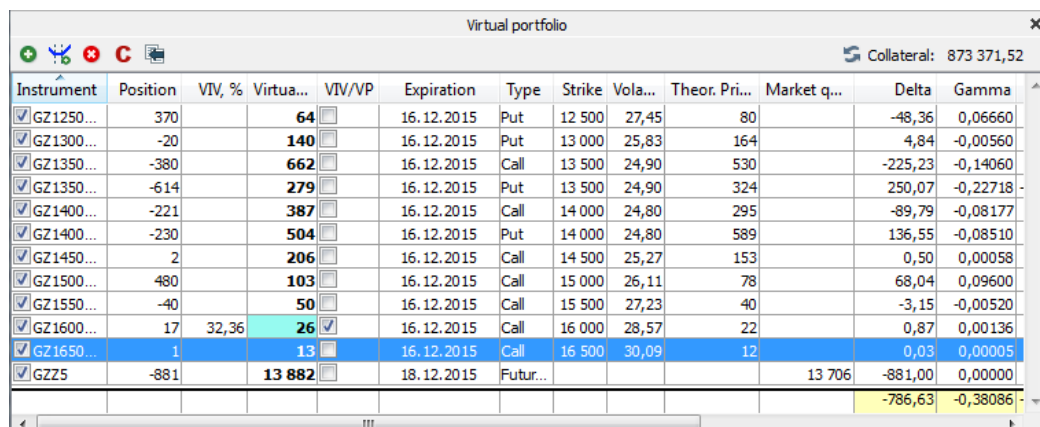

Instrument	Position	VIV, %	Virtua...	VIV/VP	Expiration	Type	Strike	Vola...	Theor. Pri...	Market q...	Delta	Gamma
<input checked="" type="checkbox"/> GZ1250...	370		64		16.12.2015	Put	12 500	27,45	80		-48,36	0,06660
<input checked="" type="checkbox"/> GZ1300...	-20		140		16.12.2015	Put	13 000	25,83	164		4,84	-0,00560
<input checked="" type="checkbox"/> GZ1350...	-380		662		16.12.2015	Call	13 500	24,90	530		-225,23	-0,14060
<input checked="" type="checkbox"/> GZ1350...	-614		279		16.12.2015	Put	13 500	24,90	324		250,07	-0,22718
<input checked="" type="checkbox"/> GZ1400...	-221		387		16.12.2015	Call	14 000	24,80	295		-89,79	-0,08177
<input checked="" type="checkbox"/> GZ1400...	-230		504		16.12.2015	Put	14 000	24,80	589		136,55	-0,08510
<input checked="" type="checkbox"/> GZ1450...	2		206		16.12.2015	Call	14 500	25,27	153		0,50	0,00058
<input checked="" type="checkbox"/> GZ1500...	480		103		16.12.2015	Call	15 000	26,11	78		68,04	0,09600
<input checked="" type="checkbox"/> GZ1550...	-40		50		16.12.2015	Call	15 500	27,23	40		-3,15	-0,00520
<input checked="" type="checkbox"/> GZ1600...	17	32,36	26		16.12.2015	Call	16 000	28,57	22		0,87	0,00136
<input checked="" type="checkbox"/> GZ1650...	1		13		16.12.2015	Call	16 500	30,09	12		0,03	0,00005
<input checked="" type="checkbox"/> GZZ5	-881		13 882		18.12.2015	Futur...				13 706	-881,00	0,00000
											-786,63	-0,38086

Fig. 7.10. Options calculator. Virtual portfolio

You can edit records in the **Virtual portfolio** section.

The following parameters' values can be edited:

- **Position** and virtual values - **VIV** and **VP**. To edit a record, double-click it with the left mouse button, enter a new value and press **Enter**;
- **Instrument, Expiration, Type, Strike** - values in these fields can be replaced with new ones from the drop-down lists in the appropriate column. To activate the edit mode you should double-click the selected cell with the left mouse button or press **F2**. Please note, that the drop-down lists contain data on active instruments only, so that you are unable to edit data on an instrument with the elapsed exercise date. The field **Instrument** offers the context search for instrument codes: the drop-down list will automatically display the most relevant codes according to the data you have typed in. Please also note, that you are unable to enter an instrument code other than what you've been offered in the drop-down list!

The last lines in the **Virtual portfolio** contain the total values for the columns; these lines are highlighted in yellow. Please note that the output string in the portfolio table displays greeks values only for active instruments.

You can specify set and order of parameters according to your needs via the **Window settings** context menu item of the **Columns** tab for **Virtual portfolio** (see section 11.3).

Tab. 7.5. Parameters in Virtual portfolio area

Parameter	Details
Instrument	<p>Instrument short code.</p> <p>The option specifies if the instrument's data will be added onto graphical chart or not.</p> <p>If the option is enabled, the instrument's data will be added onto the graphical chart.</p> <p>If the option is disabled, the instrument's data will not be added onto the graphical chart.</p>
Position	Current position.
VIV	<p>Virtual implied volatility (VIV).</p> <p>By default, the field contains the implied volatility value (field Volatility).</p> <p>This field is editable, so that you can add any implied volatility value.</p> <p>If a value in the field VIV has been changed, the option VIV/VP becomes enabled automatically (if it was not enabled before). The field is highlighted with cyan colour, and its value freezes and gets unchangeable. According to this value, the values in the field VP, as well as the greeks, get recalculated, and the graphical charts get redrawn.</p> <p>You can change the highlighting colour via the setting Active virtual value cell background colour (Settings/ Terminal settings, section Colours) - see section 10.5.</p>
Virtual price	<p>Virtual price - average-weighted (VP).</p> <p>This parameter's value should be set multiple to the price tick value, and should meet the option price interval calculated at the maximum (1000) and minimum (1) volatility values. If you set an incorrect virtual price value, the value will be automatically equated to the closest valid value.</p> <p>The default value is taken from the theoretical price value (field Theor. price) for options, and from the market quotation value (field Market quot.) for futures.</p>



Parameter	Details
	<p>If a value in the field VP has been changed, the option VIV/VP becomes enabled automatically (if it was not enabled before). The field is highlighted with cyan colour, and its value freezes and gets unchangeable. According to this value, the values in the field VIV, as well as greeks, get recalculated, and the graphical charts get redrawn.</p> <p>You can change the highlighting colour via the setting Active virtual value cell background colour (Settings/ Terminal settings, section Colours) - see section 10.5.</p> <p>When importing the real portfolio data into the virtual portfolio, the field will be filled in with the average-weighted position price value for open position.</p>
VIV/VP	<p>Use virtual values for calculation.</p> <p>When the option VIV/VP is enabled, it turns on the calculation mode for values in fields with greeks using the input values of the fields VIV and VP. The field used for calculation will be highlighted in cyan colour.</p> <p>Enabling this option will lead to the following:</p> <ul style="list-style-type: none"> • if values in the fields VIV and VP were not specified before, than the field VIV adopts the current value from the field Volatility (implied volatility), • otherwise, a value from either field VIV or VP will be used. <p>If the option VIV/VP is disabled, then values in the fields with greeks are calculated in accordance with incoming values in the fields Volatility and Theor. price</p> <p>Once the option is disabled, the value freezes either in the field VIV or VP (the last edited one), and value is removed from the other field (VIV or VP, respectively). The fields VIV or VP are no more highlighted.</p>
Expiration	Instrument expiration date.
Type	<p>Instrument type:</p> <ul style="list-style-type: none"> • futures; • option Call; • option Put.
Strike	Option exercise price.
Volatility	Option volatility.
Theor. price	Option theoretical price.
Quote	Current quotation.
Delta	Rate of option premium change relative to underlying asset price.
Gamma	Rate of option delta change if underlying asset price has changed by 1.
Vega	Rate of option delta change if volatility has changed by 1.
Theta	Rate of option delta change relative to time (till expiration): amount of money the option loses per single day.
Days before expiration date	Number of days before instrument expiration date.
Buy	Best buy order price.
Sell	Best sell order price.
Price	Price of closing trade.

You can manage records in virtual portfolio using buttons in the instrument panel (see section 7.4.1) or context menu items (the context menu should be opened from the virtual portfolio area). Apart from executing the standard command **Window settings** (see Chapter 11), the context menu items allow to make the following:

- **Chart, Virtual portfolio, Real portfolio** - these menu items allow to show or hide the appropriate area of the window;
- **Undo (Ctrl+Z)** - undo the latest action in virtual portfolio;
- **Redo (Ctrl+Y)** - redo the latest action in virtual portfolio;
- **Add position** - open the window to add a position into virtual portfolio (see section 7.4.3.2);
- **Add strategy** - open the window to add a strategy into virtual portfolio (see section 7.4.3.3);
- **Remove position** - remove selected records from virtual portfolio (see section 7.4.3.4);
- **Clear** - remove all records from virtual portfolio (see section 7.4.3.4);
- **Import data** - import data from file (see section 7.4.3.1);
- **Add order** - opens a form to add order on the selected instrument (see section 6.2.3.1);
- **Request to NCC for <instrument code>** – opens the request to NCC window for the selected instrument (see section 6.2.5);
- **Open all trades** - open the window **All trades** on the selected instrument (see section 6.3.1);
- **Open Order-book** - open the order-book window on the selected instrument (see section 6.2.2). This command is set as the default, i.e. it can be run by double clicking the selected instrument with the left mouse button;
- **Add chart** - open a new window Tech. analysis and add both series and **Volume** index charts on the selected instrument (see section 9.2);
- **Add volatility curve** - add volatility curve chart in a dedicated window (see section 7.3);
- **Information** - open the window **Information** on the selected instrument (see section 6.1.1).

7.4.3.1. Import data into virtual portfolio

You can import data into virtual portfolio:

- from real portfolio by pressing the  button to load all data from real portfolio to virtual portfolio. The data from both portfolios are merged.
- from text csv-file by pressing the  button on the local panel or by pressing the **Ctrl+Alt+I** key combination. This operation loads all data from csv-file to virtual portfolio, deleting all data stored in your virtual portfolio. A message appears on the screen: "Are you sure you want to import data into virtual portfolio? All previous data in virtual portfolio will be lost." To continue, press **Yes**, to cancel press **No**. To turn the confirmation message on or off, use the **Confirmation when loading data from real portfolio to virtual portfolio from file (Settings/ Terminal settings)** option in the **Option calculator** section).

When you import data from text csv-file the first screen is the window of selecting a file to import:

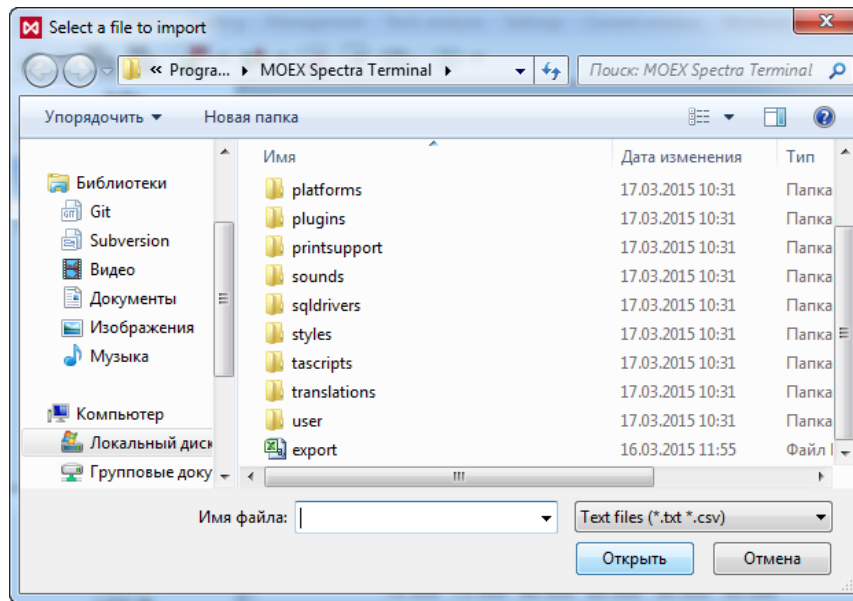

Fig. 7.11. Select a file to import

Select the import file and press the button **Open**.

Importing data via the **Option calculator data importing Wizard**:

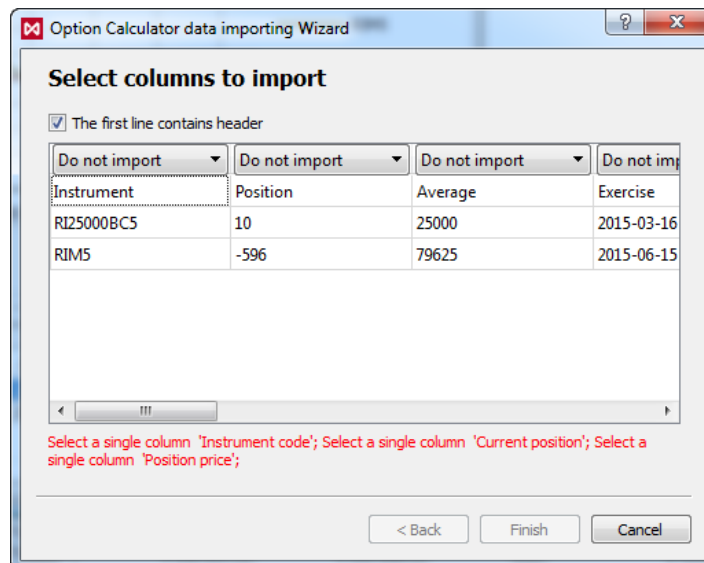

Fig. 7.12. Option calculator data importing Wizard. The first screen.

You should select columns to import data from.

Every column header contains a drop-down list, where you should select a value. Otherwise, select **Do not import**, if you do not need to import these data. Every value can be selected only once.

The fields below are mandatory:

- **Instrument code**;
- **Current position**;
- **Position price**.

The mandatory fields are highlighted with red. After all the mandatory fields are filled in, the list below the table will disappear. To finish, press **Finish**:

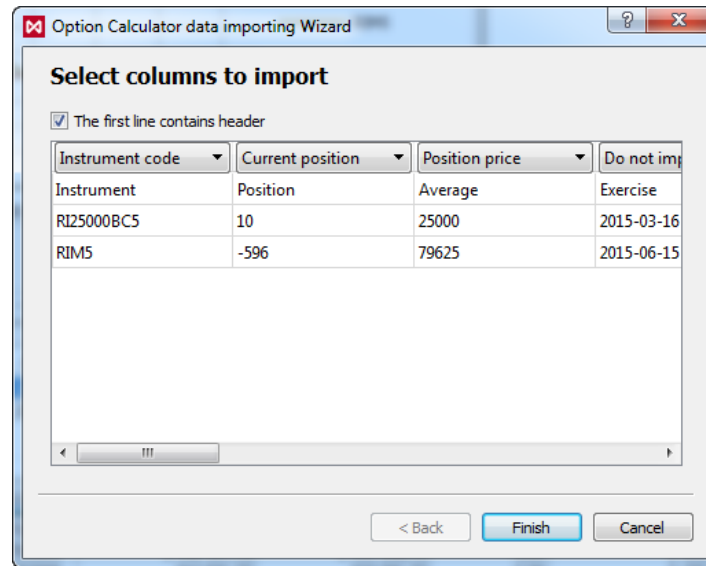

Fig. 7.13. Option calculator data importing Wizard. All the mandatory fields selected.

In case of any error (incorrect file, import parameters error, etc.), the import will be canceled. You will receive the error message like below:

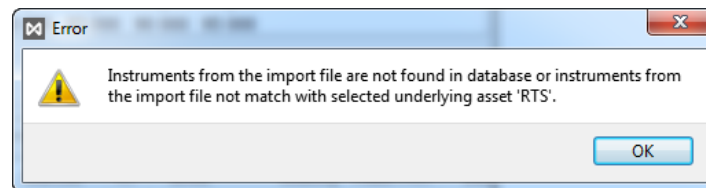

Fig. 7.14. Import error message

In this case, you should return to the initial step and try to refill all the fields correctly.

When import ended successfully, you will receive the following message:

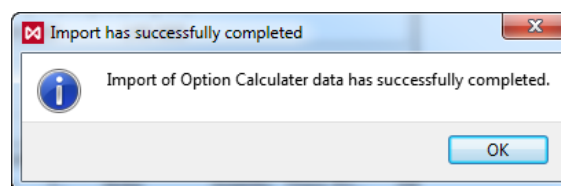



Fig. 7.15. Import completed successfully message

After that the downloaded data are immediately displayed in the **Virtual portfolio**, graphics rebuilt automatically. If the Virtual portfolio contained some data, they will be lost and replaced by imported.

7.4.3.2. Add position into virtual portfolio

You can add a new record into the virtual portfolio section by the following methods:

- by pressing the  button on the local instrument panel;

- via the **Add position into virtual portfolio** context menu item (the context menu should be opened from the virtual portfolio section);
- by pressing the **Ctrl+Alt+P** key combination;
- drag record from **Real portfolio** to **Virtual portfolio**. If you need to drag more than one file, select the records you need to drag with mouse, holding the **Ctrl & Shift** keys pressed. It is possible to drag records of different client accounts from **Real portfolios** into the same **Virtual portfolio**. You can do this by selecting client account numbers from a drop-down menu in the **Real portfolio** area.

Before adding the position, you should fill in the following form:

Fig. 7.16. Options calculator. Adding a position into virtual portfolio.

Tab. 7.6. Parameters in the Add position into virtual portfolio window

Parameter	Details
Und. asset	Selected underlying asset code.
Type	Instrument type: <ul style="list-style-type: none"> • futures; • option Call; • option Put.
Ex. date	Exercise date for futures and options.
Strike	Option exercise price. Not available for futures.
Instrument	Instrument code. Filled in automatically according to the exercise date and strike price.
Position	Position for the selected instrument to virtual portfolio. Positive value - buy position. Negative value - sell position.

7.4.3.3. Add strategy into virtual portfolio

You can add new positions into virtual portfolio in accordance with an appropriate option strategy by pressing the  button on the local panel or by pressing the **Ctrl+Alt+A** key combination.

A special window is used for selecting strategies:

Fig. 7.17. Options calculator. Add strategy to virtual portfolio.

Tab. 7.7. Parameters of option strategy

Parameter	Details
Strategy	<p>Option strategy to add positions into virtual portfolio.</p> <p>Below is the list of standard option strategies:</p> <ul style="list-style-type: none"> • one strike: <ul style="list-style-type: none"> • Synthetic futures • Straddle • Strap/Strip • two strikes: <ul style="list-style-type: none"> • Bull spread • Bear spread • Strangle • Ratio spread • Ratio backspread • Backspread • three strikes: <ul style="list-style-type: none"> • Butterfly • four strikes: <ul style="list-style-type: none"> • Condor
Ex. date	<p>Exercise date for futures and options.</p> <p>You can select more than one dates in the drop-down list (if available).</p>
Strike 1	Option exercise price.
Strike 2	Option exercise price.
Strike 3	Option exercise price.
Strike 4	Option exercise price.

Parameter	Details
Position	Position for the selected strategy to virtual portfolio. Positive value - buy position. Negative value - sell position.

The number of fields **Strike** available for editing depends on the number of strikes in the selected strategy (strikes can be selected in the drop-down list).



Please note, that the rule *Strike 1 < Strike 2 < Strike 3 < Strike 4* is applied to strikes. If this rule is violated, you will not be able to finalize adding positions as the **OK** button becomes inactive.

The selected strategy will be applied to the selected underlying asset with the opened window **Options calculator**.

New positions for the appropriate instruments will be added into **Virtual portfolio** according to the strategy selected. For every strategy, there are several records added into **Virtual portfolio**. For all options in the strategy the current market prices are used.

7.4.3.4. Remove position from virtual portfolio

You can delete records in the **Virtual portfolio** section by the following ways:

- by selecting the records and pressing the  button on the local instrument panel;
- via the **Remove position from virtual portfolio** context menu item - the mouse cursor should be placed over the record for deletion (or a group of records should be selected);
- by selecting the records and pressing the **Ctrl+Alt+R** key combination;
- by selecting the records and pressing the **Delete** key;
- by pressing the  (**Remove virtual portfolio data**) button on the local instrument panel or by pressing the **Ctrl+Alt+C** key combination. This action removes all records from the virtual portfolio section. A message appears on the screen: "Are you sure you want to delete all data of virtual portfolio?" To continue, press **Yes**, to cancel press **No**. To turn the confirmation message on or off, use the **Confirmation when deleting data from virtual portfolio** (**Settings/ Terminal settings** option in the **Option calculator** section).

If you need to delete more than one record, select them using the **Ctrl** and **Shift** key combination, then perform one of the operations listed above.

7.4.3.5. Virtual portfolio data export

You can export the virtual portfolio data into CSV file via the **Export** context menu item opened in the virtual portfolio area. Please note, that data from hidden columns will not be exported. Data from hidden parameters will not be exported as well.

The status of checkboxes (Enabled/Disabled) of the fields **Instrument** and **VIV/VP** will be inherited.

A detailed description of the procedure to export data - see section 5.12.

7.4.3.6. Recalculate collateral

For virtual portfolio, you can calculate a necessary collateral amount:

- by pressing button  on the local instrument panel;
- via the context menu item **Recalculate collateral**. Note that the context menu should be opened from **Virtual portfolio** area.

The calculated collateral amount value is displayed right of the button . Please note that collateral amount value will not be recalculated automatically every time a new records adds into virtual portfolio! To recalculate the collateral amount manually, please use one of the methods described above.

You can copy the calculated collateral value to clipboard for later usage in other applications by using the context menu item **Copy collateral to clipboard**. Please note that the context menu should be opened from **Virtual portfolio** area.

7.4.3.7. Greeks calculation formulas

Using the option calculator, you can calculate sensitivity of option prices also known as greeks. Greeks are partial derivatives from the option's price.

The terminal has the ability to select an option pricing model (see section 11.1):

- Black-Scholes model - see section 7.4.3.7.1;
- Bachelier model allows you to work with negative prices - see section 7.4.3.7.2.

7.4.3.7.1. Black-Scholes model

According to the Black - Scholes option pricing model, call option price can be expressed as follows:

$$C = S\Phi(d_1) - K\Phi(d_2)$$

where:

$$d_1 = \frac{\ln\left(\frac{S}{K}\right) + \left(\frac{\sigma^2}{2}\right)T}{\sigma\sqrt{T}}$$

$$d_2 = \frac{\ln\left(\frac{S}{K}\right) - \left(\frac{\sigma^2}{2}\right)T}{\sigma\sqrt{T}} = d_1 - \sigma\sqrt{T}$$

- **S** - underlying asset price
- **T** – years before option exercise date;
- **K** – option's exercise price
- **σ** – option volatility
- **Φ** – normal distribution function

Put option price can be expressed as follows:

$$P = K\Phi(-d_2) - S\Phi(-d_1) = C + K - S$$

Tab. 7.8. Greeks calculation formulas for Black - Scholes option pricing model

Greek's name	Formula	Details
Delta	Call option : $\Delta = \Phi(d_1)$ Put option: $\Delta = \Phi(d_1) - 1$	q=0

Greek's name	Formula	Details
Gamma	$\Gamma = \frac{\phi(d_1)}{\sigma S \sqrt{T}}$	q=0
Vega	$V = \frac{S \sqrt{T} \phi(d_1)}{100}$	1/100 - value in % q=0
Theta	$\theta = \frac{S \sigma \phi(d_1)}{2 \sqrt{T} \times 365}$	r=0 q=0 1/365 - daily calculated value

Where:

- **r** - riskless rate;
- **q** - dividend.

The number of days in a year is always 365, i.e. there is no extra day added in a leap year.

$$\sigma = f(K, S, T, x_0, A, B, C, D, E) = A + B \times (1 - e^{-Cy^2}) + D \times [\arctan(E \times y)]/E$$

$$y = 1/\sqrt{T} \times \ln(K/S) - x_0$$

where:

- **A, B, C, D, E, x** – volatility coefficients
- **K** – strike
- **S** – underlying asset price
- **y** – Strike's distality from money, normalized by time and shifted by x.

Apart from the greeks listed above there is one more greek called **Po**. This greek's value, though, is around zero, therefore, we can easily omit it.

Normal distribution formula, where $t \geq 0$, is as follows:

$$P(t) = 1 - \left(\frac{e^{-\frac{t^2}{2}}}{\sqrt{2\pi}}\right)(1.330274y^5 - 1.821256y^4 + 1.781478y^3 - 0.156563y^2 - 0.3193815y)$$

$$y = \frac{1}{1 + 0.2316419t}$$

7.4.3.7.2. Bachelier model

According to the Bachelier option pricing model, option price can be expressed as follows:

$$C = (F - K) \cdot N(d) + \sigma \sqrt{T} \cdot n(d)$$

$$P = C - F + K$$

where:

- **C, P** - call and put option prices, accordingly;
- **K** – option strike;
- **F** – base futures price;
- **T** – time before expiration in fractions of a year;
- **d** – auxiliary calculated value:

$$d = \frac{F - K}{\sigma\sqrt{T}}$$

- **n** – density function of standard normal distribution,
- **N** – standard normal distribution function:

$$n(z) = \frac{1}{\sqrt{2\pi}} \cdot \exp\left(-\frac{z^2}{2}\right)$$

$$N(z) = \frac{1}{\sqrt{2\pi}} \cdot \int_{-\infty}^z \exp\left(-\frac{u^2}{2}\right) du$$

Tab. 7.9. Greeks calculation formulas for Bachelier option pricing model

Greek's name	Formula	Details
Delta	$N(d)$	Call options
	$N(d) - 1$	Put options
Gamma	$\frac{n(d)}{\sigma\sqrt{T}}$	
Vega	$n(d)\sqrt{T}$	The value in points, such as the price of the underlying asset
Theta	$\frac{\sigma \cdot n(d)}{2\sqrt{T} \times 365}$	1/365 - daily calculated value

The number of days in a year is always 365, i.e. there is no extra day added in a leap year.

7.4.4. Charts

Only virtual portfolio data are used for adding charts. You can add up to four charts, where each chart will reflect a cumulative value of a single parameter for all instruments at once.

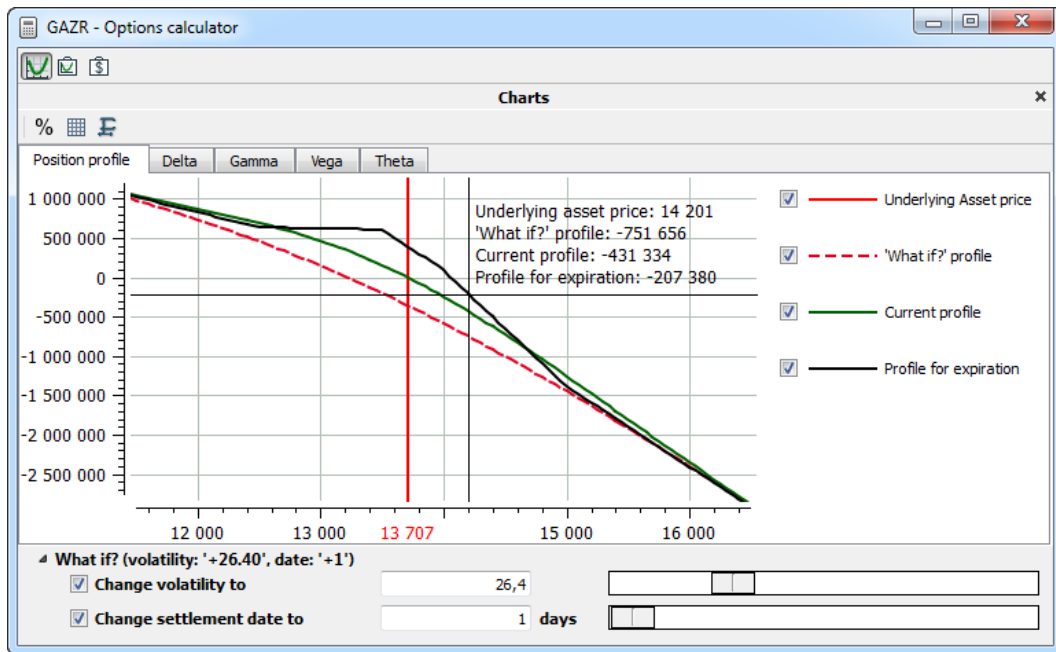

Fig. 7.18. Options calculator. Charts

The **Charts** area consists of several tabs containing different chart types fig. 7.7:

- **Position profile** - cumulative charts on virtual portfolio data;
- **Delta, Gamma, Vega and Theta** - option greeks.

The red vertical line indicates the current price of the underlying asset (the nearest futures) in all charts.

Each tab may contain up to 4 charts:

- red vertical line - current **Underlying asset price** (the nearest futures);
- full black line - **Profile for expiration**. The chart is calculated as if there is 0 days before the exercise date (the actual value is 0.01 seconds);
- full green line - **Current profile**. The chart is calculated according to the current values for volatility and days before exercise date.
- dotted red line - **'What if?' profile**. The chart is calculated according to the current values of the area **What if?**

On the right side of the chart area there is a legend for all types of charts. You can hide any chart in the chart area by removing a tick next to the chart description and make it visible again by placing tick back. By default, all charts are visible (ticked).

The H-axis in all tabs contains strike value, while the V-axis contains value of the parameter selected for adding chart. To switch display mode for the H-axis use the % button. There are two display modes available:

- strikes absolute values;
- absolute values with bias from the central strike value, in percent, where 0% corresponds the central strike value.

The button  of the instrument panel allows to switch between two grid scale modes in the chart area: large and small.

If a chart scale has been occasionally changed, the automatic scale button  (**Auto scaling**) will put the chart back into visible area of the window.

When you place mouse cursor over a chart area, a crosshair appears on the screen displaying values for the particular point of the chart area: underlying asset price and profit, position worth or option greeks values (please note, that the

values are displayed for the visible charts only!). The displayed values may not correspond the precise axis coordinates; the prompting message will display the nearest value. The crosshair and the message text color correspond that of the chart.

Methods for scaling graphs:

- you can zoom charts in and out using the mouse wheel;
- using the keys **Ctrl** and **Shift** you can change charts' scales independently by axis. To do this, you should first press either **Ctrl** or **Shift**, and then use the mouse wheel in order to zoom scale in and out. Placing the mouse cursor somewhere in the chart area and holding either **Ctrl** or **Shift** pressed, you can use the mouse wheel to enlarge or reduce scale of the X-axis or the Y-axis, respectively. Please note, that if you place the mouse cursor somewhere on an axis, pressing the keys **Ctrl** or **Shift** will not cause any effect, and scale will change for this exact axis, exclusively;
- by changing scale smoothly with mouse: click the left mouse button on the axis and move cursor from left to the right, and vice versa, zooming the chart in and out along the selected axis.

You can move around the chart by clicking and holding the left mouse button.

There is an area **What if?** right above the virtual portfolio area, which allows to redraw the existing charts in accordance with the parameters - see section 7.4.4.1.

The charts can be exported into CSV file format (see section 7.4.4.2) or JPG/PNG file format (see section 7.4.4.3).

Also, you can use the instrument panel buttons to make actions in the chart area (see tab. 7.3) or context menu items opened from the virtual portfolio area. There are some extra commands you can run from the context menu apart from the standard commands (see Chapter 11 for information on the standard commands):

- **Charts, Virtual portfolio, Real portfolio** - these menu items allow to hide/show the appropriate area of the window;
- **X-axis displays percentage** - allows to switch display mode for the H-axis;
- **Small grid** - allows to switch between two grid scale modes;
- **Auto scaling** - will put the chart back into visible area of the window If a chart scale has been occasionally changed;
- **Export** - allows to export chart data into a text file format CSV (see section 7.4.4.2);
- **Save chart as...** - allows to export chart data into a graphical file format: JPG or PNG (see section 7.4.4.3).

7.4.4.1. Modeling values for charts

There is an area **What if?** right above the virtual portfolio area, which allows to redraw the existing charts in accordance with the parameters **Change volatility to** or **Change settlement date to** values.

Fig. 7.19. Options calculator. Charts - What if? area

To specify the parameter values, you should enable these parameters (one or two) first by ticking the appropriate checkbox. Then, you will be able to specify the values by typing them using keyboard or via a range-slider situated on the right side. Using keyboard, you can specify range of volatility values from -1000 to +1000, and exercise period range from -365 till +365. Using the slider, you can specify range of volatility values from 0 to +100, and exercise period range from 0 till +365. You can specify either a single parameter, or both parameters. These fields contain not absolute values but relative displacement.

If there is at least one parameter specified, its value will be displayed in brackets right to the label **What if?**. Note that the values remain visible even if you minimize the section **What if?** by pressing the small triangle at the left side. To maximize the section back press the same small triangle again.

After parameters is enabled and specified, the charts for all instruments in the virtual portfolio will be redrawn in accordance rather to the selected volatility value or the selected exercise date. The changes will be applied to all option instruments in the virtual portfolio.

The parameters checkboxes become available only if there is at least one option instrument added into the virtual portfolio.

Changing parameters of VIV and VP will also cause graphical charts to redraw (for details see tab. 7.5).

7.4.4.2. Charts export to text file format

The charts can be exported into CSV file. You can use the **Export** context menu item, opened in a chart area. The command affects all charts, i.e. all data of all charts will be exported.

```

UA price;Instrument;Profit/Loss;Position worth;Delta;Gamma;Vega;Theta
24 000;GZZ4;9079215.00000;21240885.00000;0.00000;0.00000;0.00000;0.00000
23 500;GZZ4;8636715.00000;20798385.00000;0.00000;0.00000;0.00000;0.00000
23 000;GZZ4;8194215.00000;20355885.00000;0.00000;0.00000;0.00000;0.00000
22 500;GZZ4;7751715.00000;19913385.00000;0.00000;0.00000;0.00000;0.00000
22 000;GZZ4;7309215.00000;19470885.00000;0.00000;0.00000;0.00000;0.00000
21 500;GZZ4;6866715.00000;19028385.00000;0.00000;0.00000;0.00000;0.00000
21 000;GZZ4;6424215.00000;18585885.00000;0.00000;0.00000;0.00000;0.00000
20 500;GZZ4;5981715.00000;18143385.00000;0.00000;0.00000;0.00000;0.00000
20 000;GZZ4;5539215.00000;17700885.00000;0.00000;0.00000;0.00000;0.00000
19 500;GZZ4;5096715.00000;17258385.00000;0.00000;0.00000;0.00000;0.00000

```

Fig. 7.20. Export CSV file for charts

7.4.4.3. Charts export to image file format

The charts can be exported into JPG or PNG file. You can use the **Save as** context menu item, opened in a chart area. The command affects only the charts in current tab.

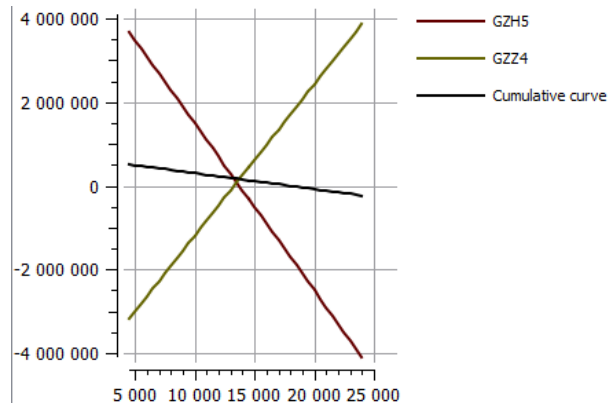

Fig. 7.21. Export JPG file for charts

Chapter 8. Management

The following functional windows are described in this chapter:

- **Market maker obligations for futures, Market maker obligations for IQS futures** - see section 8.2;
- **Market maker obligations for options, Market maker obligations for IQS options** - see section 8.1;
- **Limitation** - see section 8.3;
- **Settlement account assets** - see section 8.4;
- **Manage BF parameters** - see section 8.5;
- **Manage client parameters** - see section 8.6;
- **Prohibitions** - see section 8.7;
- **Option exercise rules** - see section 8.8;
- **Users** - see section 8.10;
- **SMA-user order verification** - see section 8.11;
- **Settlement Account assets (clearing)** - see section 8.12;
- **Client assets (clearing)** - see section 8.13;
- **Collateral breakdown** - see section 8.14;
- **Requests to deposit/ withdraw funds** - see section 8.15;
- **Position profiles transfer requests** - see section 8.16;
- **Collateral transfer requests** - see section 8.17.



8.1. Market maker obligations for options

The **Market maker obligations for options** window displays list of option instruments the market maker has obligations for. The window can be opened via the **Management/ Market maker obligations for options** main menu item.

Also, there is a similar window containing obligations for IQS **Market maker obligations for IQS options**, which can be opened via a main menu item **Management/ Market maker obligations for IQS options**.

The list of futures instruments the obligation the market maker has obligations for is displayed in a separate window. For details see section 8.2.

To maximize details, you should click the small black triangle in the first column.

Clicking the  or  button (in the first column header) allows to maximize or minimize all groups at once. Button changes its appearance automatically.

Account	Instrument	Code	Spread by agr...	Amount by agr...	Fulfilment (%)	Min fulfilment ...	Part fulfilment ...
Agreement 2							
Central strike							
820,00000 SBF5 - янв 12, 2015 (3rd week) (American: futures-style)							
7500000	SB820BA5	SBER-1.15M120115CA 820	11,00	22	0,00	70,00	80,00
7500000	SB840BA5	SBER-1.15M120115CA 840	10,00	20	0,00	70,00	80,00
7500000	SB820BM5	SBER-1.15M120115PA 820	13,00	23	0,00	70,00	80,00
Central strike							
820,00000 SBF5 - янв 12, 2015 (3rd week) (American: futures-style)							
7500035	SB820BA5	SBER-1.15M120115CA 820	11,00	22	0,00	70,00	80,00
7500035	SB840BA5	SBER-1.15M120115CA 840	10,00	20	0,00	70,00	80,00
7500035	SB820BM5	SBER-1.15M120115PA 820	13,00	23	0,00	70,00	80,00
Central strike							
820,00000 SBF5 - янв 12, 2015 (3rd week) (American: futures-style)							
7500044	SB820BA5	SBER-1.15M120115CA 820	11,00	22	0,00	70,00	80,00
7500044	SB840BA5	SBER-1.15M120115CA 840	10,00	20	0,00	70,00	80,00
7500044	SB820BM5	SBER-1.15M120115PA 820	13,00	23	0,00	70,00	80,00

Fig. 8.1. Window Market maker obligations for options

In the tree view mode, obligations are grouped according to agreements. Within every agreement, obligations are grouped by underlying assets and client accounts. The information is displayed in the following order:

- agreement displays first;
- inside every agreement, there is group of records grouped by underlying asset. The first record in every group contains aggregated obligation values for group of the client accounts, which have obligations within this group. The **Batch of MM** field contains **Yes**. The **Batch of MM** field contains **No** for the rest records. There may be more than one aggregated records for every agreement, according to the number of group of obligations for the agreement. Moreover, if there is only one client account in the group, the first item to display is always the aggregated record, and then obligation for the client account. Aggregated record may contain a random value in the field **Account**. Although, the value in this field usually indicates an account code of client, which is a part of batch.;
- after that, there are obligations for particular client accounts for the group are displayed. The **Account** field contains a 7-symbol code of client.

Tab. 8.1. Parameters in the Market maker obligations for options and Market maker obligations for IQS options windows

Parameter	Details
Instrument	Instrument short code.
Fulfilment (%)	Obligations fulfilment (%).
Spread	Current spread in points.
Spread by agreement	Spread by agreement .
Sell price	The highest sell price within the spread.
Amount to sell	Amount of contracts in offers withing the spread.
Buy price	The lowest buy price within the spread.
Amount to buy	Amount of contracts in buy orders withing the spread.
Amount by agreement	Amount by agreement.
Option type	Option type (put/call).
Strike price	Strike price.
Settlement	Instrument settlement date.
Start	Start of validity period MM rules.
End	End of validity period MM rules.

Parameter	Details
Code	Instrument code.
Min fulfilment (%)	Min obligation fulfilment per trading session (%).
Part fulfilment (%)	Part obligation fulfilment per trading session (%).
Complete fulfilment (%)	Complete obligation fulfilment per trading session (%).
Agreement	Agreement number.
Account	Client code.
Und. contract	Underlying contract short code.
Broker	Broker code.
Obligations	
Central strike	Central strike for option group.
Name	Option group name.
Agreement	Agreement number.
Account	Client code.
Broker	Broker code.
Min. ex. %	Minimal percent of obligation fulfilment for series of option.
Avg. ex. proc.	Average exercise fulfilment percentage for series of option.
Batch of MM	Flag of batchn: <ul style="list-style-type: none"> • Yes - the record contains aggregated obligation values for group of the client accounts, which have obligations within this group.; • No - obligations for particular client accounts.

You can specify set and order of parameters according to your needs (via **Window settings/ Columns/ Columns - obligations fulfilment**, **Window settings/ Columns/ Obligations-** obligations)

You can manually specify the field width via the **Window settings/ Columns/ Obligations** window settings form, by dragging the field border by mouse. The bottom of the page contains the line layout preview.

There can be more than one lines in the table for every instrument, each line for each trading session.

If the market maker obligations are not fulfilled, the following fields will be highlighted in red: **Spread by agreement**, **Amount by agreement**, **Min fulfilment (%)**, **Part fulfilment (%)** and **Complete fulfilment (%)**. If there is an instrument within the a series of option, for which the market maker obligation is not fulfilled, its underlying asset like will be also highlighted in red. If the market maker obligations are fulfilled, these objects will be highlighted in green. You can specify the highlight colour parameters via the **Settings/ Terminal settings** main menu item in the **Colours** section of the **Market maker obligations** tab.

You can sort records in the window by the following parameters: **Option type** and **Strike price**, in both directions. To switch the sorting direction, click the appropriate column header with the left mouse button.

For your convenience, you can set the sound (see section 8.2.2) and visual (see section 8.2.3) warnings.

Instruments from the **Market maker obligations for options** window can be dragged into the favorite instruments area in the side panel.

By pressing the  button on the local instrument panel or via the **Recalculate central strike** context menu item, you can recalculate the central strike value for a series of options.

Before recalculation starts, you may receive a confirmation message. You can specify the confirmation message settings via the **Settings/ Terminal settings** main menu item of the **Management** section, by using the **Confirmation on recalculation of central strike for market maker obligations** option.

Apart from the **Recalculate central strike** command, the context menu contains the standard commands (see. Chapter 11).

The standard context menu items are described in Chapter 11. Below you will find description for the particular **Options board** window context menu items. There are:

- **Recalculate central strike** - recalculate central strike for options group;
- **Open Order-book** – opens the **Order-book** window for the selected instrument. The window can be also opened by double-clicking an instrument with the left mouse button;
- **Open chart** – opens the **Tech. analysis** window, containing graphical chart for the selected instrument;
- **Add volatility curve** -adds the volatility curve chart into a separate window. This menu item is available only for options;
- **Information** - opens the **Information** window, containing data on the selected instrument.

8.1.1. Filters in the Market maker obligations for options window

You can specify the **Market maker obligations for options** window filter settings via the **Window settings** context menu item of the **Filters** section.

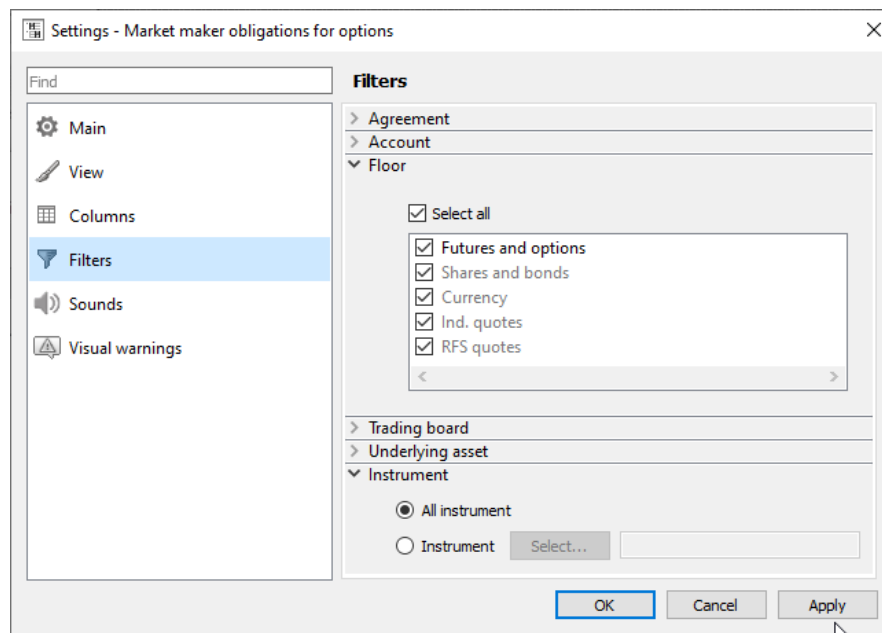

Fig. 8.2. Setting filters in the Market maker obligations for options window

When a filter has been applied, the **Market maker obligations for options** window will contain only the instruments allowed under the filter preferences. You can manually select the needed instruments by checking/unchecking checkboxes left of the instrument names with the left mouse button.

By default, the **Market maker obligations for options** window contains all possible obligations.

Tab. 8.2. Filter parameters in the Market maker obligations for options window

Parameter	Details
Agreement	Filter by agreement number. If the Select all option is active, then the window will contain all agreements. If the Select all option is inactive, the window will be empty. To select the agreements you need, you should select them manually by checking the appropriate checkboxes.

Parameter	Details
Account	Filter by account code of clien. If the Select all option is active, then the window will contain records for all accountS. If the Select all option is inactive, the window will be empty. To select the accounts you need, you should select them manually by checking the appropriate checkboxes.
Floor	Filter by trading floor. If the Select all option is active, then the window will contain all obligations for all trading floors. If the Select all option is inactive, the window will be empty. To select the floors you need, you should select them manually by checking the appropriate checkboxes.
Trading board	Filter by trading board. If the Select all option is active, then the window will contain all obligations for all boards. If the Select all option is inactive, the window will be empty. To select the trading board you need, you should select them manually by checking the appropriate checkboxes.
Underlying asset	Filter by underlying asset. If the Select all option is active, then the window will contain all trades for all underlying assets. If the Select all option is inactive, the window will be empty. To select the underlying assets you need, you should select them manually by checking the appropriate checkboxes.
Instrument	Filter by instrument code: <ul style="list-style-type: none"> • All instruments – MM obligations for all instruments; • Instrument – MM obligations only for selected instrumens. You can select an instrument in the Select instrument window (see. section 5.11.1) by pressing the Select button. Note that you can select more than one instruments at once.

The **Select all** option allows to select/deselect all parameters at once.

To cancel filtration you can use the **Window settings** context menu item of the **Filters** section.

Once you close the window and then open it again, the window will be open in its default configuration, causing all your filter settings to be lost. To save your settings, you should save the current configuration as default via the **Current window/ Save by default** main menu item. This configuration becomes active even after restarting the application.

To automatically save the current configuration when you exit the terminal should install option **Save the current desktop settings before exit (Settings/ Terminal settings/ Main/ Common)**.

8.2. Market maker obligations for futures

The **Market maker obligations for futures** window displays a list of instruments under market maker obligations. The list contains not only the futures instruments, but the multi-leg instruments, for example, calendar spreads as well.

You can open the window via the **Management/ Market maker obligations for futures** main menu item.

Also, there is a similar window containing obligations for IQS **Market maker obligations for IQS futures**, which can be opened via a main menu item **Management/ Market maker obligations for IQS futures**.

The market makers obligations for options are displayed in a separate window, see section 8.1.

Information in the **Management/ Market maker obligations for futures** window can be displayed in two modes: table and tree.

Switching between these types of display is performed using the buttons of the local toolbar:

-  - table;
-  - tree.

Agreement	Account	Code	Instrument	Spread by agree...	Amount by agre...	Fulfilment (%)	Min fulfilmen...	Part fulfil...	Complete ful...
1	5000000	GDBK-12.14	DBZ4	110	17	0,00	70,00	80,00	95,00
1	5000000	GDBK-12.14	DBZ4	110	17	0,00	70,00	80,00	95,00
1	5000000	SPU4-3.15	SPH5	100	25	0,00	70,00	80,00	95,00
1	5000013	SPU4-3.15	SPH5	100	25	0,00	70,00	80,00	95,00
1	5000021	GDBK-12.14	DBZ4	110	17	0,00	70,00	80,00	95,00
1	5000023	GDBK-12.14	DBZ4	110	17	0,00	70,00	80,00	95,00
1	5000023	SPU4-3.15	SPH5	100	25	0,00	70,00	80,00	95,00
1	5000024	SPU4-3.15	SPH5	100	25	0,00	70,00	80,00	95,00
1	5000025	GDBK-12.14	DBZ4	110	17	0,00	70,00	80,00	95,00
5000000	5000000	SPU4-3.15	SPH5	100	25	0,00	70,00	80,00	95,00
5000000	5000042	SPU4-3.15	SPH5	100	25	0,00	70,00	80,00	95,00

Fig. 8.3. The Market maker obligations for futures window in table mode

You can arrange records in the table (in table mode) by any column in both directions. To switch between directions, click the left mouse button on a column header.

Yes in the field **Batch of MM** indicates an aggregated record for group of obligations. The number of records depend of that of group of obligations.

Account	Instrument	Code	Fulfilment (%)	Min fulfilment (%)	Part fulfilment (%)	Complete fulfilme...	Spr
Agreement							
1							
Und. asset	Agreement	Account	Broker	Min ex. %	Avg. ex.perc.		
GDBK	1	5000000	5000	0,00	0,00		
5000000	DBZ4	GDBK-12.14	70,00	80,00	95,00		
Und. asset	Agreement	Account	Broker	Min ex. %	Avg. ex.perc.		
GDBK	1	5000025	5000	0,00	0,00		
5000025	DBZ4	GDBK-12.14	70,00	80,00	95,00		
Und. asset	Agreement	Account	Broker	Min ex. %	Avg. ex.perc.		
GDBK	1	5000000	5000	0,00	0,00		
5000000	DBZ4	GDBK-12.14	70,00	80,00	95,00		
Und. asset	Agreement	Account	Broker	Min ex. %	Avg. ex.perc.		
GDBK	1	5000021	5000	0,00	0,00		
5000021	DBZ4	GDBK-12.14	70,00	80,00	95,00		
Und. asset	Agreement	Account	Broker	Min ex. %	Avg. ex.perc.		
GDBK	1	5000023	5000	0,00	0,00		
5000023	DBZ4	GDBK-12.14	70,00	80,00	95,00		
Und. asset	Agreement	Account	Broker	Min ex. %	Avg. ex.perc.		
SPU4	1	5000000	5000	0,00	0,00		
5000000	SPH5	SPU4-3.15	70,00	80,00	95,00		
Und. asset	Agreement	Account	Broker	Min ex. %	Avg. ex.perc.		
SPU4	1	5000013	5000	0,00	0,00		
5000013	SPH5	SPU4-3.15	70,00	80,00	95,00		
Und. asset	Agreement	Account	Broker	Min ex. %	Avg. ex.perc.		
SPU4	1	5000023	5000	0,00	0,00		
5000023	SPH5	SPU4-3.15	70,00	80,00	95,00		
Und. asset	Agreement	Account	Broker	Min ex. %	Avg. ex.perc.		
SPU4	1	5000024	5000	0,00	0,00		
5000024	SPH5	SPU4-3.15	70,00	80,00	95,00		

Fig. 8.4. The Market maker obligations for futures window in tree mode



In the tree view mode, obligations are grouped according to agreements. Within every agreement, obligations are grouped by underlying assets and client accounts. The information is displayed in the following order:

- agreement displays first;
- inside every agreement, there is group of records grouped by underlying asset. The first record in every group contains aggregated obligation values for group of the client accounts, which have obligations within this group. The **Batch of MM** field contains **Yes**. The **Batch of MM** field contains **No** for the rest records. There may be more than one aggregated records for every agreement, according to the number of group of obligations for the agreement.

Moreover, if there is only one client account in the group, the first item to display is always the aggregated record, and then obligation for the client account. Aggregated record may contain a random value in the field **Account**. Although, the value in this field usually indicates an account code of client, which is a part of batch.;

- after that, there are obligations for particular client accounts for the group are displayed. The **Account** field contains a 7-symbol code of client.

To maximize details, you should click the small black triangle in the first column.

In the tree view mode, you can maximize and minimize data structure view using the special button  / . The button can be found in the line containing the table columns headers.

Tab. 8.3. Parameters in the Market maker obligations for futures and Market maker obligations for IQS futures windows

Parameter	Description
Instrument	Instrument short code.
Spread	Current spread in points.
Sell price	The highest sell price within the spread.
Amount to sell	Number of sell contracts withing the spread.
Buy price	The lowest buy order price within the spread.
Amount to buy	Amount of contracts in bids withing the spread.
Spread by agreement	Spread by agreement .
Amount by agreement	Amount by agreement.
Fulfilment (%)	Obligations fulfilment (%).
Start	MM rules start of effectivity.
End	MM rules end of effectivity.
Account	Client code.
Min fulfilment (%)	Min obligation fulfilment per trading session (%).
Part fulfilment (%)	Part obligation fulfilment per trading session (%).
Complete fulfilment (%)	Complete obligation fulfilment per trading session (%).
Code	Instrument code.
Board	Instrument code.
Underlying asset	Underlying asset code.
Settlement	Instrument settlement date.
Type	Instrument type.
Name	Instrument name.
Agreement	Agreement number.
Broker	Broker code.
Obligations	
Und. asset	Underlying asset code.
Agreement	Agreement number.
Account	Client code.
Broker	Broker code.
Min. ex. %	Minimal percent of obligation fulfilment.
Avg. ex. perc.	Average percent of obligation fulfilment.
Batch of MM	Flag of batchn:

Parameter	Description
	<ul style="list-style-type: none"> • Yes - the record contains aggregated obligation values for group of the client accounts, which have obligations within this group.; • No - obligations for particular client accounts.

You can specify set and order of parameters according to your needs (via **Window settings/ Columns/ Columns - obligations fulfillment, Window settings/ Columns/ Obligations-** obligations)

You can manually specify the field width via the **Window settings/ Columns/ Obligations** window settings form, by dragging the field border by mouse. The bottom of the page contains the line layout preview.

There can be more than one lines in the table for each instrument, because there is a dedicate line for every trading session and every client account.

If the market maker obligations are not fulfilled, the following fields will be highlighted in red: **Spread by agreement, Amount by agreement, Min fulfilment (%), Part fulfilment (%)** and **Complete fulfilment (%)**. If the obligations are fulfilled, these fields are highlighted in green. You can specify your own colour schemes via the **Settings/ Terminal settings** main menu item, in the **Colours** section in the **Market maker obligations** tab.

The context menu contains only the standard set of commands – see Chapter 11.

For your convenience, you can also enable sound (see section 8.2.2) and visual notifications (see section 8.2.3).

Instruments from the **Market maker obligations for futures** window can be dragged into the favorite instruments window on the side panel.

8.2.1. Filters in the Market maker obligations for futures window

You can specify filter settings for the **Market maker obligations for futures** window in the following ways:

- by using the **Window settings** context menu item of the **Filters** section;
- via the **Add filter 'parameter'** context menu item. Filter will be applied according to the parameter in the cell under mouse cursor. If the parameter under mouse cursor is not applicable for filtering, then the **Add filter** menu item will be absent in the context menu. The list of applicable parameters can be found via the **Window settings/ Filters** context menu item.

After filter has been applied according to a parameter, its column header in the **Market maker obligations for futures** window will be marked in bold. The parameter name in the **Window settings/ Filters** list will be also highlighted in bold.

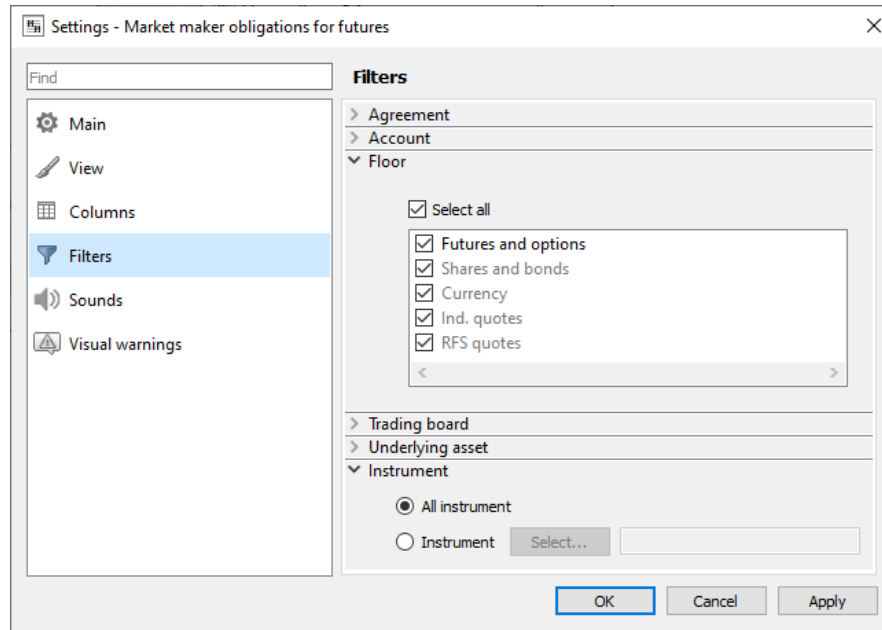

Fig. 8.5. Setting filters in the Market maker obligations for futures window

When a filter has been applied, the **Market maker obligations for futures** window will contain only the strings allowed under the filter preferences. You can manually select the needed parameters by checking/unchecking checkboxes left of the parameter names with the left mouse button.

By default, the **Market maker obligations for futures** window contains all possible strings.

Tab. 8.4. Filter parameters in the Market maker obligations for futures window

Parameter	Details
Agreement	Filter by agreement number. If the Select all option is active, then the window will contain all agreements. If the Select all option is inactive, the window will be empty. To select the agreements you need, you should select them manually by checking the appropriate checkboxes.
Account	Filter by account code of clien. If the Select all option is active, then the window will contain obligations for all accounts. If the Select all option is inactive, the window will be empty. To select the accounts you need, you should select them manually by checking the appropriate checkboxes.
Floor	Filter by trading floor. If the Select all option is active, then the window will contain all obligations for all trading floors. If the Select all option is inactive, the window will be empty. To select the floors you need, you should select them manually by checking the appropriate checkboxes.
Trading board	Filter by trading board. If the Select all option is active, then the window will contain all obligations for all boards. If the Select all option is inactive, the window will be empty. To select the trading board you need, you should select them manually by checking the appropriate checkboxes.
Underlying asset	Filter by underlying asset. If the Select all option is active, then the window will contain all obligations for all underlying assets. If the Select all option is inactive, the window will be empty. To select the underlying assets you need, you should select them manually by checking the appropriate checkboxes.
Instrument	Filter by instrument code: <ul style="list-style-type: none"> • All instruments – MM obligations for all instruments;

Parameter	Details
	<ul style="list-style-type: none"> • Instrument – MM obligations only for selected instruments. You can select an instrument in the Select instrument window (see. section 5.11.1) by pressing the Select button. Note that you can select more than one instruments at once.

You can deactivate the applied filter by the following ways:

- via the **Clear filter '...'** context menu item - to remove the filter for one parameter. Please note, that this menu item is available only in the context menu of the column, by which the filter has been applied (the column header will be marked in bold);
- via the **Remove all filters** context menu item - to remove all filters for all parameters. This menu item becomes available in the context menu when at least one filter has been applied to the list. Please note, that this menu item is available only in the context menu of the column, by which the filter has been applied (the column header will be marked in bold);
- via the **Window settings** context menu item of the **Filters** section. To remove filters simply activate the **Select all** mode.

Once you close the **Market maker obligations for futures** window and then open it again, the window will be open in its default configuration, causing all your filter settings to be lost. To save your settings, you should save the current configuration as default via the **Current window/ Save by default** main menu item. This configuration becomes active even after restarting the application.

Once you close the window and then open it again, the window will be open in its default configuration, causing all your filter settings to be lost. To save your settings, you should save the current configuration as default via the **Current window/ Save by default** main menu item. This configuration becomes active even after restarting the application.

To automatically save the current configuration when you exit the terminal should install option **Save the current desktop settings before exit (Settings/ Terminal settings/ Main/Common)**.

8.2.2. Setting sound notification at non-fulfillment of obligations

You can enable sound notifications to be played at non-fulfillment of market maker obligations via the **Window settings** context menu item, in the **Sounds** section.

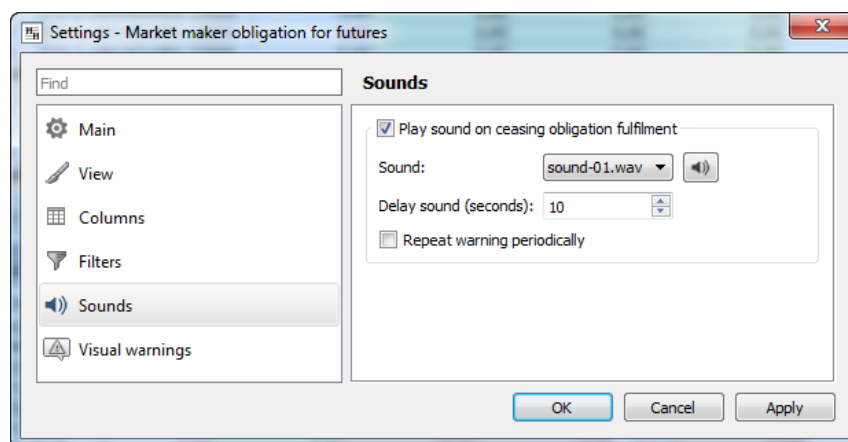

Fig. 8.6. Setting sound notifications

When the **Play sound on ceasing obligation fulfilment** option is enabled, then, if the market maker obligation is not fulfilled within the time frame specified in the **Delay sound (seconds)** field, the system will play a single sound notification.

You can set the sound notification to play periodically during the whole period of non-fulfillment of a market maker obligation. To do this, you should enable the **Repeat warning periodically** option; after this, the system will play a sound notification periodically according to a value specified in the **Delay sound (seconds)** field.

You can select a sound to be played in a drop-down list in the **Sound** field. To preview the selected sound, press a button with speaker.

The sound notification settings are not saved automatically at closing the **Market maker obligations** window; to save it manually, you should save the current window configuration as the default configuration via the **Current window/ Save as default** main menu item.

By default, the sound notifications are disabled.

8.2.3. Setting visual warning for default of market maker obligations

You can enable visual notifications to be played at non-fulfillment of market maker obligations via the **Window settings** context menu item, in the **Visual warnings** section.

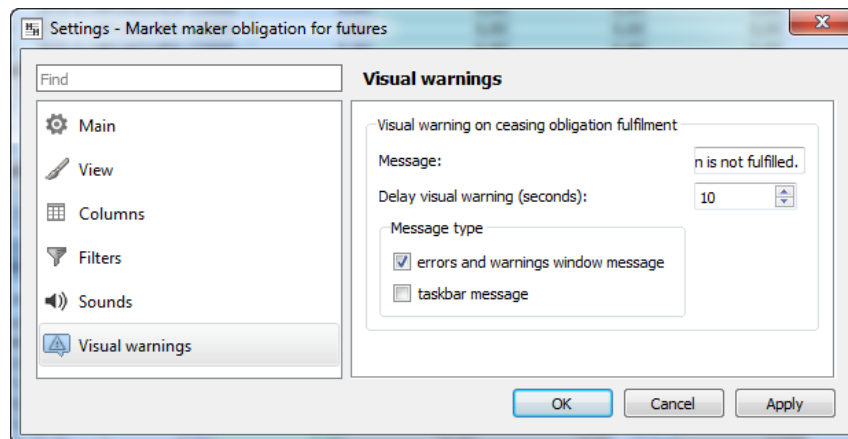



Fig. 8.7. Setting visual warning

When the option is enabled, then, if the market maker obligation is not fulfilled within the time frame specified in the **Delay visual warning (seconds)** field, the system will display a visual notification. There are three types of notifications are available:

- **errors and notifications window message** - the visual warning appears as a pop-up message in the tray above the terminal icon. Also, it displays in the **Errors and notifications** window, which can be opened by clicking  in the status bar;
- **task bar message** - the visual warning appears as a flashing terminal icon in the task bar. Please note, that the icon flashes only if the application window is inactive!

You can select both types of notifications at once.

In the **Message** window, you can enter a text message to appear as a message at obligation non-fulfillment. Also, the message will contain the date and time of the obligations non-fulfillment as well as the appropriate client account code and the instrument code.

The visual notification settings are not saved automatically at closing the **Market maker obligations** window; to save it manually, you should save the current window configuration as the default configuration via the **Current window/ Save as default** main menu item.

By default, the visual notifications are disabled.

8.3. Limitation window

CF and BF trading limits are the funds deposited by the CF or the BF on their accounts in the exchange clearing center. By the BF funds we mean the whole amount of funds deposited on the BF clients accounts. By the CF funds we mean the whole amount of funds deposited on the CF clients accounts (brokerage firms), including the CF funds themselves.

Funds can be transferred by CF between its BF accounts (and the CF account, as well) during the trading session time. The total CF funds amount remain unchanged.

The trading limits are used for reserving negative variation margin, collecting fees, collecting/paying premiums and reserving collaterals.

The client limits can be set by the CF traders (the CF client limits) and BF traders (BF client limits). The BF limits can be set by the CF Chief Traders only if they are also allowed to withdraw funds from the trading system.

When limits are set, the CF funds remain unchanged.

If there is a funds or pledges limit set for a particular BF, some prior verifications will be performed. When an order is added into the trading system, the system will verify sufficiency of free funds on the BF account, then sufficiency of free funds on the CF account (the sum of free funds of all the CF's BF + free funds of the CF itself). Please note, that if the free funds amount on the BF account is insufficient, only orders adding for closing positions is allowed.

The trading limit for client is specified by BF or CF. When an order is added into the trading system, the system will verify sufficiency of funds for the client. If no client limits have been specified, the system performs verification for the BF and its CF. Generally, the order will be added only if all three participants (client, BF and CF) have enough funds.

If the limits set to 0, only closing of positions is allowed.

If limits are not set, it means that there are no any limitations for trading.

The **Limitation** window provides access to administrative functions. To open the window, use the **Management/ Limitation** main menu item.

Depending on login used, the list may contain different client accounts:

- **CF** - information on all clients' accounts of all brokerage firms for this CF - see fig. 8.8 (CF - FT). Brokerage firms are aggregated by their settlement accounts: FT000, FT000_1, FT010 etc;

Account/Settlement a...	Funds, total	Main currency, total	Available funds	VM reserved	Variation m...	Fee Dis...
500005	0,00	0,00	0,00	0,00	0,00	0,00
505v	0,00	0,00	0,00	0,00	0,00	0,00
505v000	0,00	0,00	0,00	0,00	0,00	0,00 set
50ZZ	0,00	0,00	0,00	0,00	0,00	0,00
50ZZ000	0,00	0,00	0,00	0,00	0,00	0,00 set
50ZZlik	0,00	0,00	0,00	0,00	0,00	0,00
50002	-991 644 457 792,59	-991 644 519 812,59	-991 645 485 892,59	0,00	0,00	0,00
5017	-991 644 457 792,59	-991 644 519 812,59	-991 646 513 992,59	0,00	0,00	0,00
5017000	0,00	0,00	0,00	0,00	0,00	0,00 set

Fig. 8.8. Limitation window for CF

- **BF** - information on all clients' accounts for this BF - see fig. 8.9(BF - FT06). If a settlement account is not recognised, the system returns the message 'Unknown SA';

Account/Settlement a...	Funds, total	Main currency, total	Available funds	VM reserved	Variation m...	Fee Dis...
Unknown SA	15 796 675 966 904,83	15 797 268 691 429,56	15 796 674 631 682,76	0,00	0,00	0,00
5000				0,00	0,00	0,00
5000000				0,00	0,00	0,00
5000013				0,00	0,00	0,00
5000021	102 279 708,46	102 279 708,46	102 239 481,08	0,00	0,00	0,00 set
5000022	445 882 346,54	445 882 346,54	445 881 731,54	0,00	0,00	0,00 none
5000023	16 448 565,76	16 448 565,76	16 227 696,87	0,00	0,00	0,00 set
5000024	980 539 590,24	980 539 590,24	980 539 590,24	0,00	0,00	0,00 none
5000025	76 905 000 520,00	76 905 000 520,00	76 903 957 715,23	0,00	0,00	0,00 set

Fig. 8.9. Limitation window for BF

- **client** - information on the client's account only - see fig. 8.10.

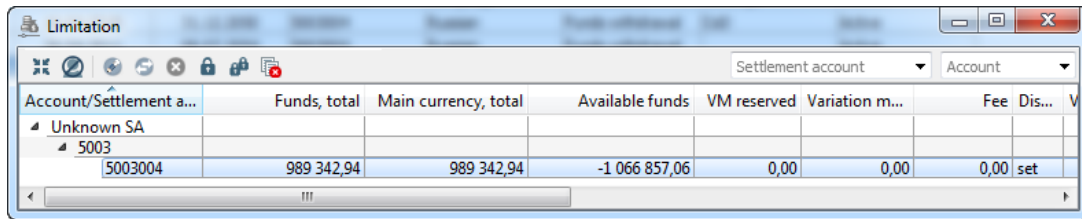









Fig. 8.10. Limitation window for client

Tab. 8.5. Parameters in the Limitation window

Parameter	Details
Account/ Settlement account	Client code or NCC settlement account .
Name	Section name.
Funds, init	Funds at session start.
Main cur., initial	Main currency initial amount.
Funds, total	Funds limit for the particular client.
Main cur., total	Main currency tota amountl.
Full collateral	Estimated value of full collateral, total.
Available funds	Amount of free funds on the client account.
Funds blocked	Amount of blocked funds on the client account.
VM reserved	Funds reserved of closed positions.
Variation margin for intraday clearing	Variating margin collected or accrued in the intermediate clearing session.
Fee	Collected fee.
Correction	Flag of automatic limit correction after the clearing session: <ul style="list-style-type: none"> • off – the client limit will be set by firm basing on clearing reports; • on – the client limit will be set automatically after the clearing session.
Limits	Funds limits set: set or none
Settlement account	NCC Settlement account.
Free money (forecast)	Free money (forecast).
Variation margin	Variation margin, accrued by trades and calculated by the restricted current quote.
Yield	Funds idle + Funds blocked + Reserved - Funds total + Reserved blocked
Reserve	Funds and pledges blocked + Reserve blocked
Status	Accounting management/ segregated account/ lock mode (TS or CT) Possible lock modes for a Clearing Firm: <ul style="list-style-type: none"> • Lock mode by CT for CF • Lock mode by TS Possible lock modes for a Settlement Account: <ul style="list-style-type: none"> • Lock mode by TS for SA • Own SA

Parameter	Details
	<ul style="list-style-type: none"> • Client SA • Asset management • margining types: <ul style="list-style-type: none"> • BF nett position • BF half-nett position • BF half-netting • SA half-netting • BF netting • Subbrokers • SA netting • UCF-supported: <ul style="list-style-type: none"> • Unified Collateral Pool • Derivatives Market <p>Possible lock modes for a Brokerage Firm:</p> <ul style="list-style-type: none"> • Asset management • Own account • Client account • Segregated account • Lock mode by CT • Lock mode by TS <p>The field values are not applied to Client level entities.</p> <p>All values in the field should be divided by comma.</p>
Brokerage fee	Amount of the blocked brokerage fee part.

You can specify different nesting depth for the account records list:

-  - minimize group of records. All records of all levels will be minimized automatically;
-  - maximize group of records. The nested levels will not be maximized automatically: you should manually maximize every nested level;
-  or  - minimize or maximize of all records of all levels taking into account user settings. If any groups of records have been minimized, they will remain minimized. Button changes its appearance automatically. It is impossible to maximize all records of all levels, if the button  **Hide clients** is pressed;
-  or  - hide or display all clients of all BFs.

In the **Limitation** window, you can set filtering by **Account** and **Settlement account**. You can enter the account number into the field above the table manually or select it from the drop-down list. The number is case sensitive! Please note, that you should enter the whole number! The table then will display all the records belonging to the account number.

The upper line of the window contains the instrument panel - see section 8.3.1. Any command in the instrument panel can also be executed via the appropriate context menu command.

The **Limitation** window allows you to do the following:

- set, change and remove the limits for clients and BFs (separately for funds and pledges);
- strengthen or ease limiting conditions for the client collateral by specifying a special coefficient; the collateral sufficiency will be verified using this coefficient value;
- automatically set the clients limits basing on results of the previous trading session;
- funds transfer between BFs;
- set the lock mode on and off (available to Clearing Firms and Brokerage Firms).

Along with the standard commands, the context menu (see g11) contains the following commands:







- **Set limits** (the default command, can be performed by double-clicking the left mouse button on a record) – see section 8.3.2 and section 8.3.3;
- **Change limits** - see section 8.3.4. This menu item is available for client accounts only;
- **Remove limits** - see section 8.9. This menu item is available for client accounts only;
- **Transfer funds** - see section 8.3.6. This menu item is available for BF only;
- **Lock mode** - see section 8.3.5. This menu item is available for BF and CF only.



By double-clicking a client record in the **Limitation** table, the edit form will appear on the screen.

Records in the **Limitation** table can be sorted only by their account numbers. To switch between sorting directions, click the **Account/Settlement account** column header with the left mouse button.

8.3.1. Toolbar of the Limitation window

Tab. 8.6. Toolbar in the Limitation window

Icon	Command	Details
	Minimize clients	Minimizes or maximizes all records of all levels. It is impossible to maximizes all records of all levels, if the button  Hide clients is pressed.
	Maximize clients	
	Hide clients	Hide or or display all clients of all BFs.
	Show clients	
	Set limits	Opens the window to specify client limits - see section 8.3.2.
	Change limits/ Transfer Funds	Opens the window to change the existing client limits (when the cursor is over a client account line) - see section 8.3.4. Opens the window to transfer funds between brokerage firms accounts (when the cursor is over a Brokerage Firm account line) - see section 8.3.6.

Icon	Command	Details
	Remove limits	Generates a request for removing client limits - see section 8.9.
	BF lock mode	Set the Lock mode on and off - see section 8.3.5.
	CF lock mode	Set the Lock mode on and off - see section 8.3.5.

8.3.2. Setting the client limits

You can open the client limits adding form by one of the following methods:

- via the **Set limits** context menu item, which has been opened from a client account record in the **Limitation** table. The entry form (fig. 8.11) will appear on the screen containing a value in the **Account** field. This value cannot be changed;
- via the  button in the **Limitation** window.

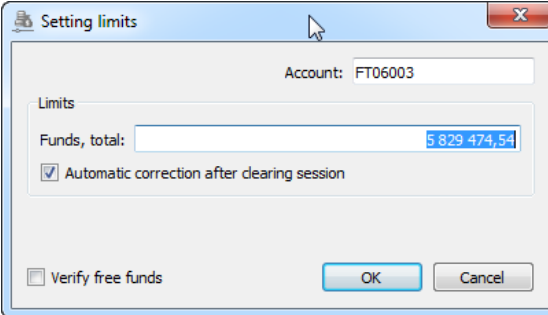

Fig. 8.11. Setting the client limits

If no limits have been specified for the account, fields in the **Setting limits** form will be blank. The mandatory fields will be highlighted with red colour.

If some limits have been already specified, then the **Setting limits** form will appear on the screen, containing the limits data. You can edit values in the fields, if necessary.

In order to manage collateral collateral amount reserved for orders you can specify a coefficient. Once the coefficient value set in the **Collateral rate** field, the collateral amount for the client's orders and positions will be calculated as product of the client's exchange collateral amount value and the coefficient set.

Tab. 8.7. Parameters in the Setting limits window for clients

Parameter	Details
Account	Client account.
Limits	
Funds, total	Funds limit. The field is mandatory.
Automatic correction after clearing session	Flag of automatic limit correction after the clearing session: <ul style="list-style-type: none"> • none – the client limit will be set by firm basing on clearing reports; • auto – the client limit will be set automatically after the clearing session.
Verify free funds	When the option is off, the limit value cannot exceed the reserved funds volume for the particular client account. When the option is on, the limit value can exceed the reserved funds volume for the particular client account.

Press **OK** to confirm changes and set the limit for the client account, or **Cancel** to undo the changes.

8.3.3. Setting BF limits

You can open the BF limits adding form by one of the following methods:

- via the **Set limits** context menu item, which has been opened from a BF account record in the **Limitation** table. The entry form (fig. 8.12) will appear on the screen containing a value in the **Account** field. This value cannot be changed;
- via the  button in the **Limitation** window (fig. 8.8).

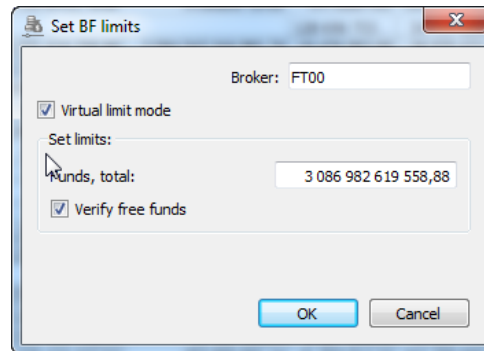

Fig. 8.12. Setting BF limits

Tab. 8.8. Parameters in the Setting BF limits window

Parameter	Details
Broker	BF account number
Virtual limit mode	<p>The option is not enabled by default, so one cannot change limits when both BFs do not belong to the same Settlement Account. Instead, a error message will appear: <i>'Unable to perform operation. The Brokerage Firms must be of the same Settlement account'</i>.</p> <p>When enabled, the option allows to change limits even if the Brokerage Firms belong to the different Settlement Accounts, according to the Virtual Limit mode. Please note that, once enabled, the Virtual Limit mode is only valid through the nearest evening clearing session, and will be disabled after the evening clearing session is over.</p>
Set limits	
Funds, total	Funds limit. The field is mandatory.
Verify free funds	<p>!The option is available only when Virtual limit mode is on!</p> <p>When the option is off, the limit value cannot exceed the reserved funds volume for the particular BF account.</p> <p>When the option is on, the limit value can exceed the reserved funds volume for the particular BF account.</p>

Press **OK** to confirm changes and set the limit for the BF account, or **Cancel** to undo the changes.

8.3.4. Changing client limits

You can change client limits by one of the following methods:

- via the **Set limit** context menu item, which has been opened from a client account record in the **Limitation** table. The entry form (fig. 8.11) will appear on the screen containing a value in the **Account** field. The limit value can be edited before clicking **OK**. This command is set as the default and can be opened by double-clicking an account record in the table (fig. 8.8) with the left mouse button;

- via the **Change limit to** context menu item, which has been opened from a client account record in the **Limitation** table. The entry form (fig. 8.13) will appear on the screen containing a value in the **Account** field (the value cannot be changed). In this form, you should enter a value to increase/decrease the current limit by.
- by pressing the  button on the local instrument panel in the **Limitation** window (fig. 8.8).

To open the limit changing form you should use the context menu item or the instrument panel only:

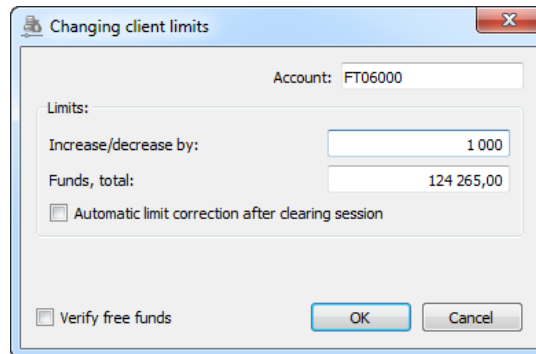



Fig. 8.13. Changing client limits

The limits changing form (fig. 8.13) is generally equal to the limits setting form (fig. 8.11). The field description can be found at tab. 8.7.

The only difference between the forms is the **Increase/decrease by** field in the limit changing form. After you entered a value into the **Increase/decrease by** field, the limit value in **Funds, total** fields will be recalculated automatically.

Also, here you can set or remove the **Automatic correction after clearing session** flag.

8.3.5. Lock mode

The **BF lock Mode** button  and **CF lock Mode** button  or context menu items are used by clearing and brokerage firms.

The button **BF lock Mode** enables lock mode for the selected Brokerage Firm.

The button **CF lock Mode** enables lock mode for all Brokerage Firms of the selected Clearing Firm.

When the **Lock mode** is on, all traders, except the Chief Trader (CT), are not allowed to act with orders. After pressing the **Lock mode** button, a dialog box appears on the screen, containing question "Switch on the Lock mode?". Answer **Yes** to switch the **Lock mode** on, or **No** to cancel. When the **Lock mode** is on, the **Limitation** window contains the special mark **Lock mode (CT)** (for BF lock mode) or **Lock mode (CT) for CF** (for CF lock mode) in the **Status** field.

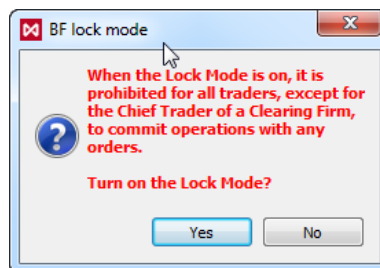

Fig. 8.14. Lock mode

To switch the **Lock mode** off, press the same button or context menu item again.



Apart from the **Lock mode (CT)**, there is a possibility to prevent the Chief Trader to act with orders as well. This mode is called **Lock mode (TS)**, and can be set by the Trading Administrator when positions are closed compulsorily. When **Lock mode (TS)** is on, the **Status** field of **Limitation** window contains the appropriate mark. Please note, that the **Lock mode (TS)** cannot be switched on or off via the trading terminal!

The lock mode can be set for the settlement account, and can be set by the Trading Administrator only. When **Lock mode by TS for SA** is on, the **Status** field of **Limitation** window contains the appropriate mark. Please note, that the **Lock mode by TS for SA** cannot be switched on or off via the trading terminal! When **Lock mode by TS for SA** is on, the following operations are prohibited:

- you can not set any orders to BFs tied to a blocked SA;
- you can not transfer positions both from a blocked SA and to a blocked SA.

8.3.6. Funds transfer between BFs

There are two methods to transfer funds from one BF account to another (please note, that cursor must be placed over the line containing BF account number!):

- via the **Transfer funds** context menu item, opened on the line containing BF account number to withdraw funds from, on the **Limitation** window;
- via the  button of the local instrument panel on the **Limitation** window (fig. 8.8). Please note, that if cursor is placed over the line containing account number of a common client or CF, the  button will execute the **Change limits** command!

To transfer funds between two BFs, you must fill in the following form:

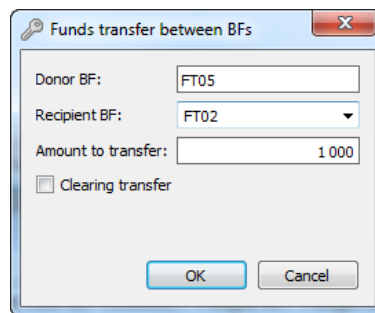

Fig. 8.15. Funds transfer between BF

Tab. 8.9. Parameters in Funds transfer between BF window

Parameter	Details
Donor BF	Donor BF account number
Recipient BF	Recipient BF account number
Amount to transfer	Amount of funds to transfer
Clearing transfer	<p>If the Clearing transfer flag is set, the funds will be transferred both during the trading session and clearing session. If the Clearing transfer flag is not set, the funds will be transferred during the clearing session only (the client will be credited). Transferred funds can be transferred onto another account during the trading session by CF order.</p> <p>Once funds have been transferred, they can be withdrawn to the client account exclusively. The option allows to protect the transferred funds from being eliminated within the evening clearing session.</p>

To transfer funds, press **OK**. The confirmation dialog will appear on the screen: "Are you sure you want to transfer ... from BF... to BF ...?". To confirm press **Yes**, to cancel press **Cancel**.

To switch off the confirmation dialog, please enable the **Do not show next time** option. To switch the confirmation dialog on again, enable the **Confirmation on working with limits** option via the **Settings/ Terminal settings** main menu item of the **Management** section.

Funds can be transferred from any account (common, AM or separate one) onto any account.

In case of separate account, funds can be transferred via the clearing transfer or be credited during the trading session (the credit amount will be then refunded). Please note, that the amount to transfer from the separate account should not exceed the amount credited by Clearing firm! After starting a trading session, the funds transfer balance will be set to 0.

8.3.7. Request to NCC for collateral verification of Brokerage Firm

In order to avoid position insufficiency, a Clearing Participant should be able to cancel orders added by a Trading Participant. As a Clearing Participant is not eligible to cancel orders directly by themselves (unlike Trading participants), there is a special feature called **Request to NCC for collateral verification of Brokerage Firm**, which can be used from window **Limitation** by two methods:

- via the context menu item **Request to NCC for collateral verification of Brokerage Firm**, opened from a line containing a Brokerage Firm account to verify collateral for;
- via the button  of the local instrument toolbar in the window **Limitation**. Please note that the button is enabled only when the account you place the mouse cursor over belongs to a Brokerage Firm!

A Clearing Participant which is not simultaneously a Trading Participant may submit a request to NCC for collateral verification of Brokerage Firms under Trading Participants; note that the given Brokerage Firms must be serviced by the Clearing Participant mentioned above.

Therefore, if a Brokerage Firm obtains negative free cash limit, all active orders, both standard and requests to NCC, of the Brokerage Firm will be cancelled on all clearing accounts under the given Brokerage Firm.

In case of non-negative free cash limit for Brokerage Firm, no actions will be taken.

A Clearing Participant which represents the same entity as a Trading Participant is prohibited from submit requests to NCC for collateral sufficiency verification of Brokerage Firm, as such Clearing Participant is eligible to cancel orders themselves.

Before your request to NCC is submitted, the following warning dialog will appear on the screen:

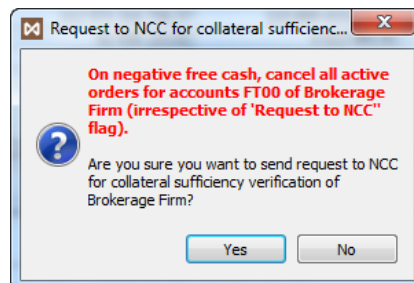

Fig. 8.16. Request to NCC for collateral verification of Brokerage Firm

To confirm submitting the request press **Yes**. To cancel your request select **No**.

8.4. Settlement account assets

Settlement account is a segment of a top-level clearing section (within margining hierarchy), which consolidates all 7-digits client accounts of one or more Brokerage firms, when Brokerage firms of a single Clearing firm are divided into groups, and each group is linked to a separate Settlement account. Note that one Clearing Firm can be linked to more than one Settlement account.

The Settlement account level is managed by NCC (National Clearing Centre), which acts as the Central counterparty. The Central counterparty sets limit values, risk calculation parameters, parameters of margining and also manages adding, withdrawing and transferring of assets.

The lower levels (Brokerage Firms and client accounts) are managed by a clearing participant. They set limit values and collateral ratios, and also specify order blocking conditions and rules for risk calculation.

The settlement account assets can be viewed in a dedicated window which can be opened via the main menu item **Management/ Settlement account assets**.

Settlement acco...	Funds, init.	Funds, total	Available funds	Funds blocked	Full collateral	Free money (for...)
70826	11 688 167 875 6...	11 688 313 229 7...	11 680 096 295 8...	8 263 252 133,64	0,00	
70827	15 050 510 011 5...	15 050 639 924 5...	15 039 316 360 3...	11 391 303 509,87	0,00	
70828	12 132 144 240 8...	12 132 666 653 7...	12 108 059 236 3...	24 635 332 949,21	0,00	
70829	4 017 553 152 87...	4 017 554 508 54...	4 017 542 481 70...	12 052 900,93	0,00	
70830	5 019 657 968 65...	5 019 657 968 65...	5 019 657 968 65...	0,00	0,00	
70831	1 000 000 000 12...	1 000 000 000 12...	1 000 000 000 12...	0,00	0,00	
70832	1 000 000 000 12...	1 000 000 000 12...	1 000 000 000 12...	0,00	0,00	
70833	1 010 000 000 12...	1 010 000 000 12...	1 010 000 000 12...	0,00	0,00	
71421	999 001 000 000,00	999 001 000 000,00	999 001 000 000,00	0,00	0,00	

Fig. 8.17. Settlement account assets

Tab. 8.10. Settlement account assets window parameters

Parameter	Details
Settlement account	NCC Settlement account
Funds, init.	Funds at session start
Funds, total	Funds, total
Available funds	Available funds
Full collateral	Estimated value of full collateral, total
Free money (forecast)	Free money (forecast)
Base currency, total	Total base currency funds
Base cur. for the next cl. sess., total	Base currency, including forecasted VM, intraday clearing VM, and fees, total
Funds for the next cl. sess., total	Funds, including forecasted VM, intraday clearing VM, and fees, total
Variation margin	Total variation margin (by the current quote) on futures and options for this SA
Market variation margin	Total variation margin (by the current market quote) on futures and options for this SA
Margining type	Type of margining: <ul style="list-style-type: none"> • Half netting for BF • Half netting for SA
Variation margin for in-traday clearing	Variating margin collected for intraday clearing
Fee	Collected fee
Settlement Account type	Settlement account type. Allowable values: <ul style="list-style-type: none"> • Client SA • Own SA • Trust Management
Belongs to	Unified Collateral Pool support availability. Allowable values:

Parameter	Details
	<ul style="list-style-type: none"> • Unified Collateral Pool - this Settlement account supports the Unified Collateral Pool features. • Derivatives Market - this Settlement account does not support the Unified Collateral Pool features.
Funds blocked	Funds blocked
VM reserved	Variation margin for covered positions

In the **Settlement account assets** window, you can set filtering by account number. You can enter the account number into the field above the table (**Settlement account**) manually or select it from the drop-down list. The number is case sensitive! Please note that when you enter an account number manually, it is necessary to enter symbols one by one, starting from the very first one. Entering symbols in any other order, e.g. starting from one in the middle of the number, will not result in any search action. Please also note, a symbol which does not belong to any account number will not be displayed in the entry field.

8.5. Manage BF parameters

The window **Manage BF parameters** can be evoked via the main menu item **Management/ Manage BF parameters**. The window contains managing parameters for limits and collateral risks calculation for BF level. Please note that viewing and changing the parameters are available for logins starting from BF level!

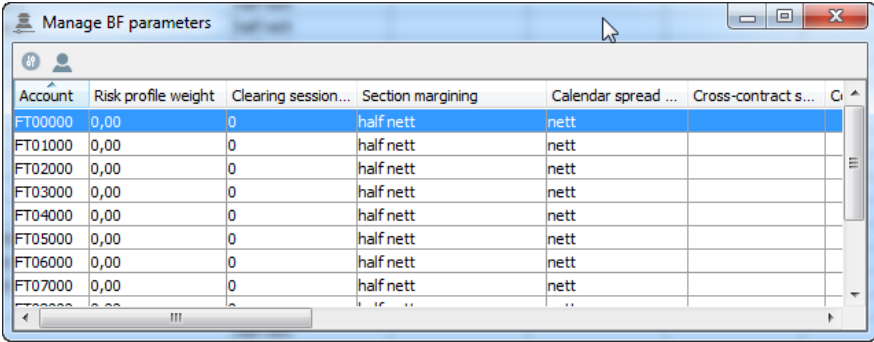

Account	Risk profile weight	Clearing session...	Section margining	Calendar spread ...	Cross-contract s...
FT00000	0,00	0	half nett	nett	
FT01000	0,00	0	half nett	nett	
FT02000	0,00	0	half nett	nett	
FT03000	0,00	0	half nett	nett	
FT04000	0,00	0	half nett	nett	
FT05000	0,00	0	half nett	nett	
FT06000	0,00	0	half nett	nett	
FT07000	0,00	0	half nett	nett	

Fig. 8.18. Manage BF parameters

Tab. 8.11. Parameters in Manage BF parameters window

Parameter	Details
Account	Client code
Name	Firm name
Code	Firm RTS code
Risk profile weight	Risk profile weight according to expiration scenarios (available range: 0 to 1)
Clearing sessions before ES	Number of clearing sessions to turn on automatic exercise scenario of risk
Section margining	Nett/ half nett (BF level)
Calendar spread margining	Calendar spread margining type
Cross-contract spread margining	Cross-contract spread margining type
Collateral coefficient	Total collateral coefficient, BF
Verify limit on withdrawal	Verify BF's trading limits and free limit on depositing/withdrawal to/from SA. When transferring within the same SA, the BF's limits are not subject to be verified in any case/
Bind limit to collateral	Limit according to the total BF's funds amount (use virtual limit otherwise)

Parameter	Details
Verify limit on adding order	Verify free limit sufficiency on adding orders, for BF
Discount	Discount on futures: <ul style="list-style-type: none"> • is missing – off; • set – on.
Risk profile weight for clients	Risk profile weight, according to the exercise scenario for client
Clearing sessions before ES, for clients	Number of clearing sessions to turn on automatic exercise scenario of risk calculation for the non-quarterly series of options with the closest expiration date for client portfolio, by default
Discount for clients	Discount on futures for client, by default

By using the **Manage BF parameters** window, you can do the following operations via the context menu items or the instrument panel buttons:

- **Change BF parameters** –  - see section 8.5.1;
- **Change BF's clients parameters** -  - see section 8.5.2.

The standard commands of the context menu - see g11.

You can sort records in the **Manage BF parameters** window by any column in any direction. To change the sorting direction, click a column header with the left mouse button. The column header then will be marked in light-blue colour, and a small arrow will appear, which shows the sorting direction.

8.5.1. Setting BF's parameters

You can open the **Specify BF's parameters** form by one of the following methods:

- via the **Change BF parameters** context menu item, which has been opened from a table line containing the chosen BF;
- via the  button in the **Manage BF parameters** window.

The changed parameters will be applied starting from the evening clearing session.

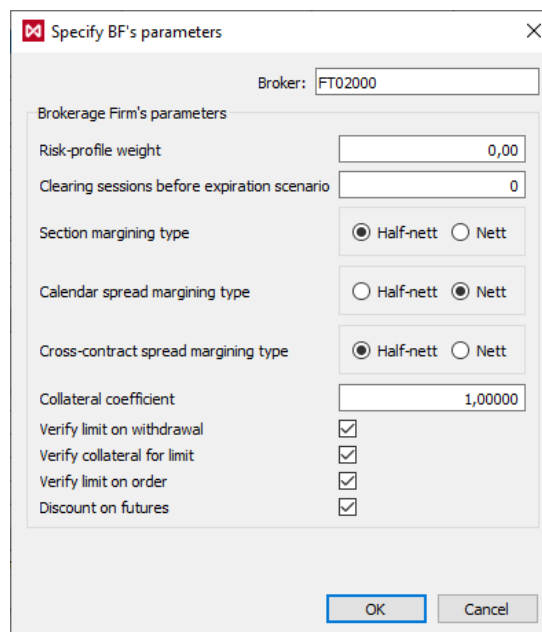

Fig. 8.19. Specify BF's parameters

Tab. 8.12. Parameters in Specify BF's parameters window

Parameter	Details
Broker	BF code. The field is non-editable. The value will be taken from the line the cursor was on while executing the parameter changing command.
Brokerage Firm's parameters	
Risk-profile weight	Risk profile weight according to expiration scenarios (available range: 0 to 1)
Clearing sessions before expiration scenario	Number of clearing sessions to turn on automatic exercise scenario of risk
Section margining type	Possible values: <ul style="list-style-type: none"> • Half-nett • Nett To select a value, click the desired option with the left mouse button.
Calendar spread margining type	Possible values: <ul style="list-style-type: none"> • Half-nett • Nett To select a value, click the desired option with the left mouse button.
Cross-contract spread margining type	Possible values: <ul style="list-style-type: none"> • Half-nett • Nett To select a value, click the desired option with the left mouse button.
Collateral coefficient	Total collateral coefficient, BF
Verify limit on withdrawal	When the setting is on, both free and trading limits for BF will be verified on withdrawal/depositing funds from/to a Settlement Account. The limit verify setting will not be applied to the transfers performed within the same Settlement Account.
Verify collateral for limit	When the setting is on, the collateral limit will strictly depend on total BF's funds value.
Verify limit on order	When the setting is on, free limit for BF will be verified for sufficiency on adding an order.
Discount on futures	When the setting is on, discount on futures will be applied on collateral calculation.

Upon pressing **OK**, you will receive a confirmation message like the following: "*Are you sure you want to change the BF's parameters?*". To confirm press **Yes**, to cancel press **No**. The confirmation dialog settings can be specified via the **Confirmation on changing BF and clients parameters (Settings/ Terminal settings/ Management)** option.

8.5.2. Setting shared parameters for BF's clients

A dedicated window **Set shared parameters for BF's clients** allows to specify default client parameters applied for all sectors of the same BF. The window can be opened with the following methods:

- via the **Change BF's clients parameters** context menu item, which has been opened from the line containing the desired BF's name;
- via the  button in the **Manage BF parameters** window.

The changed parameters will be applied during the evening clearing session.

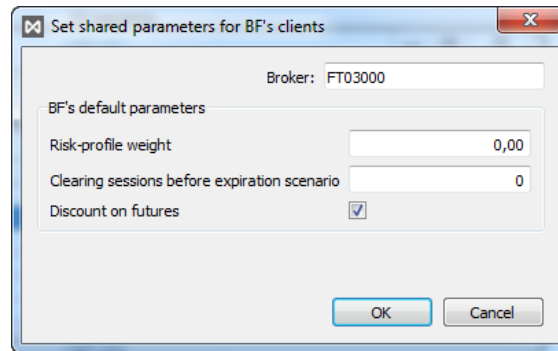

Fig. 8.20. Set shared parameters for BF's clients

Tab. 8.13. Parameters in Set shared parameters for BF's clients window

Parameter	Details
Broker	BF code. The field is non-editable. The value will be taken from the line the cursor was on while executing the parameter changing command.
BF's default parameters	
Risk-profile weight	Risk profile weight according to expiration scenarios (available range: 0 to 1)
Clearing sessions before expiration scenario	Number of clearing sessions to turn on automatic exercise scenario of risk
Discount on futures	Discount on futures for clients When the setting is on, discount on futures will be applied on collateral calculation.

Upon pressing **OK**, you will receive a confirmation message like the following: "Are you sure you want to change the BF's client parameters default values?". To confirm press **Yes**, to cancel press **No**. The confirmation dialog settings can be specified via the **Confirmation on changing BF and clients parameters (Settings/ Terminal settings/ Management)** option.

8.6. Manage client parameters

Window **Manage client parameters** can be opened via the main menu item **Management/ Manage client parameters**. The window contains parameter settings for client sections. Please note that viewing and changing the parameters are available for logins starting from BF level!



Account	Name	Calendar spread ma...	Cross-contract s...	Collateral coeff.	Discount	Clearing sessio...	Risk profile we
FT00000	Тестовая фирма 1	half nett	half nett	1,00000	set	0	same as BF's
FT00001	VasjaPupkin	half nett	half nett	1,00000	set	0	same as BF's
FT00002	PupaVas'kin	half nett	half nett	1,00000	set	0	same as BF's
FT01000	Раздел 1 для тестовой фирмы 1	half nett	half nett	1,00000	none	0	same as BF's
FT01001	Клиент раздела 1	half nett	half nett	0,50000	set	0	same as BF's
FT01002	Клиент раздела 2	half nett	half nett	0,50000	set	1	1,00
FT01003	Klient3	half nett	half nett	0,50000	set	1	0,50
FT01004	Klient4	half nett	half nett	0,90000	none	0	same as BF's
FT01005	Klient5	half nett	half nett	0,50000	set	0	same as BF's

Fig. 8.21. Manage client parameters

Tab. 8.14. Parameters in Manage client parameters window

Parameter	Details
Account	Client account
Name	Firm name
Calendar spread margining	Calendar spread margining type: <ul style="list-style-type: none"> • Half-nett • Nett
Cross-contract spread margining	Cross-contract spread margining type: <ul style="list-style-type: none"> • Half-nett • Nett CCS
Collateral coeff.	Client collateral coefficient - for managing collateral amount reserved for orders and positions of a particular client. Once the coefficient value set, the collateral amount for the client's orders and positions will be calculated as product of the client's exchange collateral amount value and the coefficient set.
Discount	Discount on futures The flag allows to use discount on futures when calculating collateral amount. When the flag is set, the discount is used.
Clearing sessions before ES	Number of clearing sessions (including intraday clearing sessions) to turn on automatic exercise scenario of risk calculation for the non-quarterly series of options with the closest expiration date for this account.
Risk profile weight	Risk profile weight according to expiration scenarios. Available values: <ul style="list-style-type: none"> • from 0 to 1 • same as BF's - indicates weight set by BF
SOMC coeff.	Short option minimum charge coefficient (available range: 0 to 5).
Blank	Blank - seven-digit code not tied to any account. It is used during the online registration operation. The blanks parameters can be changed, but you cannot perform trade operations from these codes.
Min. BF fee	Limit brokerage fee below.
Max. BF fee	Limit brokerage fee from above.
Coeff. BF fee	Multiplier coefficient to exchange fee.
Add. BF fee	Brokerage fee additional part.

By using the **Manage client parameters** window, you can do the following operations via the context menu items or the instrument panel buttons:

- **Change clients parameters** –  - see section 8.6.2;
- **Expiration risks parameters** -  - see section 8.6.4.

The standard commands of the context menu - see g11.

You can sort records in the **Manage client parameters** window by any column in any direction. To change the sorting direction, click a column header with the left mouse button. The column header then will be marked in light-blue colour, and a small arrow will appear, which shows the sorting direction.





The upper line of the window contains the instrument panel - see section 8.6.1. Any command in the instrument panel can also be executed via the appropriate context menu command.

Along with the standard commands, the context menu (see g11) contains the following commands:

- **Client parameters used in evening clearing** – see section 8.6.2;
- **Client parameters used immediately** - see section 8.6.3;
- **Expiration risks parameters** - see section 8.6.4;
- **Brokerage part parameters of client fee** - see section 8.6.5;
- **Delete brokerage part parameters of client fee** - see section 8.6.5.

8.6.1. Toolbar of the Manage client parameters window

Tab. 8.15. Toolbar in the Manage client parameters window

Icon	Command	Details
	Client parameters used in evening clearing	Set the client parameters used in evening clearing - see section 8.6.2.
	Client parameters used immediately	Set the client parameters used immediately - see section 8.6.3.
	Expiration risks parameters	Set the expiration risks parameters - see section 8.6.4.
	Brokerage part parameters of client fee	Opens window for setting brokerage part parameters of client fee - see section 8.6.5.
	Delete brokerage part parameters of client fee	Delete brokerage part parameters of client fee - see section 8.6.5.

8.6.2. Setting client parameters used in evening clearing

Some parameters of the client when they change do not immediately take effect, but are applied only at the time of the evening clearing.

One can change such client parameters using the dedicated window **Client parameters used in evening clearing**. The window can be opened by the following methods:

- via the context menu item **Client parameters used in evening clearing**, that was opened directly from the table containing the desired client;
- by pressing the appropriate button on the instrument panel .

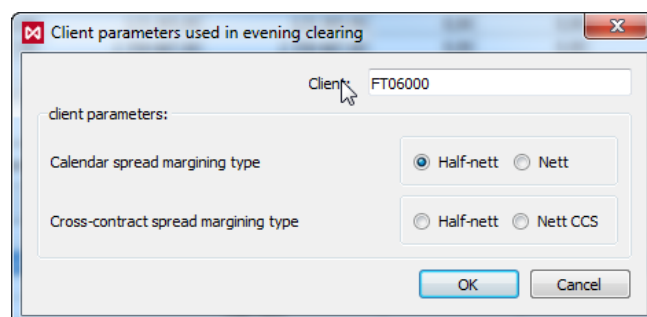

Fig. 8.22. Setting client parameters used in evening clearing

Tab. 8.16. Parameters in Client parameters used in evening clearing window

Parameter	Details
Client	BF code. The field is non-editable. The value will be taken from the line the cursor was on while executing the parameter changing command.
Client parameters	
Calendar spread margining type	Calendar spread margining type: <ul style="list-style-type: none"> • Half-nett • Nett
Cross-contract spread margining type	Cross-contract spread margining type: <ul style="list-style-type: none"> • Half-nett • Nett CCS

Upon pressing **OK**, you will receive a confirmation message like the following: "Are you sure you want to change client's parameters on account?". To confirm press **Yes**, to cancel press **No**. The confirmation dialog settings can be specified via the **Confirmation on changing BF and clients parameters(Settings/ Terminal settings/ Management)** option.

8.6.3. Setting client parameters used immediately

One can change the client parameters immediately using the dedicated window **Client parameters used immediately**. The window can be opened by the following methods:

- via the context menu item **Client parameters used immediately**, that was opened directly from the table containing the desired client;
- by pressing the appropriate button on the instrument panel .

The changed parameters will be applied during the evening clearing session.

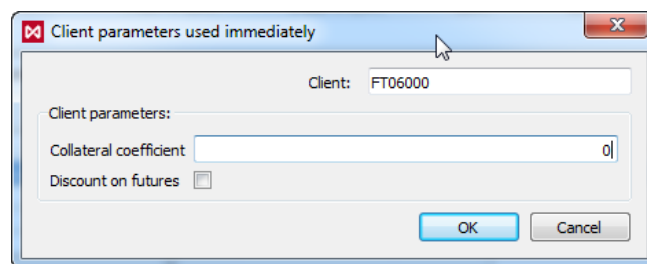

Fig. 8.23. Setting client parameters used immediately

Tab. 8.17. Parameters in Client parameters used immediately window

Parameter	Details
Client	BF code. The field is non-editable. The value will be taken from the line the cursor was on while executing the parameter changing command.
Client parameters	
Collateral coefficient	Client's collateral coefficient - for managing collateral amount reserved for orders and positions of a particular client. Once the coefficient value set, the collateral amount for the client's orders and positions will be calculated as product of the client's exchange collateral amount value and the coefficient set.

Parameter	Details
Discount on futures	The flag allows to use discount on futures when calculating collateral amount. When the flag is set, the discount is used.

Upon pressing **OK**, you will receive a confirmation message like the following: "Are you sure you want to change client's parameters on account?". To confirm press **Yes**, to cancel press **No**. The confirmation dialog settings can be specified via the **Confirmation on changing BF and clients parameters**(Settings/ Terminal settings/ Management) option.

8.6.4. Setting the expiration risks parameters

You can open the risk parameters adding form by one of the following methods:

- via the **Expiration risks parameters** context menu item, which has been opened from a client account record in the **Manage client parameters** table. The entry form (fig. 8.24) will appear on the screen containing a value in the **Account** field. This value cannot be changed;
- via the  button in the **Manage client parameters** window (fig. 8.21).

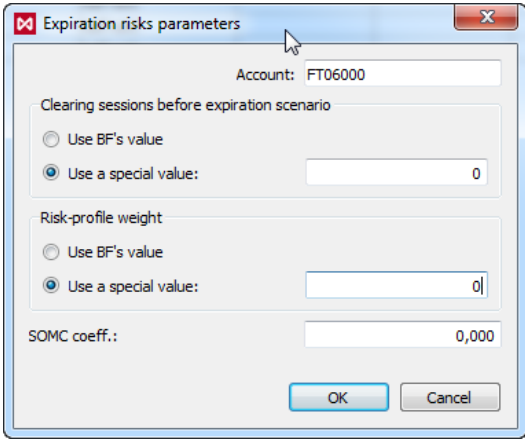

Fig. 8.24. Setting the expiration risks parameters

Tab. 8.18. Parameters in the Expiration risks parameters window

Parameter	Details
Account	Client account.
Clearing sessions before expiration scenario - number of clearing sessions to activate exercise scenarios to calculate risks for the non-quarterly series of options with the closest expiration date for this account.	
Use BF's value	A value specified by BF will be used. The table will contain a value which is same as BF's one.
Use a special value	Positive integer.
Risk-profile weight according to expiration scenarios.	
Use BF's value	A weight value specified by BF will be used. The table will contain a value which is same as BF's one.
Use a special value	Available values from 0 to 1 .
SOMC coeff.	Short option minimum charge coefficient (available range: 0 to 5).

Press **OK** to confirm changes and set the expiration risks parameters for the client account, or **Cancel** to undo the changes.

8.6.5. Setting the brokerage fee

To reduce credit risk, the broker can set additional parameters for calculating the brokerage fee for each of his client accounts. The brokerage part of the fee is blocked based on the results of the trade making, which reduces the client purchasing power. The check is not done at the order adding stage in order to that the trading system allows adding an order to close a position with a negative limit (for example, closing by margin call). Therefore, brokerage fee blocking are not implemented at the BF and Settlement Code levels.

Changing the parameters of blocking the brokerage fee is carried out in the evening clearing only. Blocking duration - from evening clearing to the next evening clearing (the blocking is reset during clearing). Further, the broker changes the limits of clients himself.

Brokerage fee is calculated based on the exchange fee. The brokerage part of the fee is calculated according to the following formula for each trade:

$$broker_fee = N \times MAX (lower_fee, MIN (upper_fee, round (multiplier \times ex_fee/N, 2) + additive))$$

- **N** - number of contracts per trade;
- **lower_fee** – minimum brokerage fee per contract, acceptable values from 0.00 to +100.00;
- **upper_fee** – maximum brokerage fee per contract, acceptable values from 0.00 to +10 000.00;
- **multiplier** – multiplier to the amount of exchange and clearing fees, acceptable values from 0.00 to +100.00;
- **additive** – constant addition per contract, acceptable values from 0.00 to +1 000.00;
- **ex_fee** - clearing and exchange fees per trade with scalper discounts.

You can setting the parameters for brokerage fees in a special form **Parameters for calculating the brokerage part of the client fee**, which can be opened by the following methods:

- via the context menu item **Parameters for calculating the brokerage part of the client fee**, that was opened directly from the table containing the desired client (**Management/ Manage client parameters**);
- by pressing the appropriate button on the instrument panel .

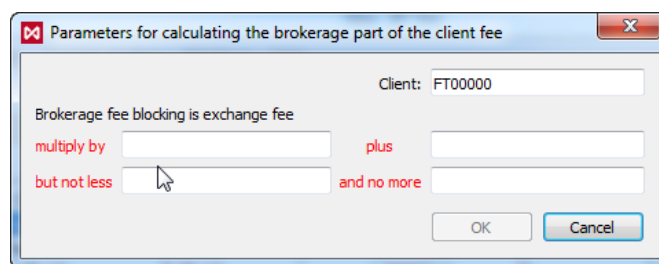

Fig. 8.25. Parameters for calculating the brokerage part of the client fee

Tab. 8.19. Parameters in "Parameters for calculating the brokerage part of the client fee" window

Parameter	Detail
Client	Seven-digit client code. The field is non-editable. The value will be taken from the line the cursor was on while executing the parameter changing command.
Brokerage fee blocking is exchange fee	
multiply by	Multiplier to the amount of exchange and clearing fees, acceptable values from 0.00 to +100.00 (mult parameter in the formula).

Parameter	Detail
plus	Constant addition per contract, acceptable values from 0.00 to +1 000.00 (add parameter in the formula).
but not less	Minimum brokerage fee per contract, acceptable values from 0.00 to +100.00 (lower_fee parameter in the formula).
and no more	Maximum brokerage fee per contract, acceptable values from 0.00 to +10 000.00 (upper_fee parameter in the formula).

Upon pressing **OK**, you will receive a confirmation message like the following: "Do you want to change the brokerage fee parameters for the account ...?". To confirm press **Yes**, to cancel press **No**. The confirmation dialog settings can be specified via the **Confirmation on changing BF and clients parameters**(Settings/ Terminal settings/ Management) option.

You can delete the parameters for brokerage fee:

- via the context menu item **Delete parameters for calculating the brokerage part of the client fee**, that was opened directly from the table containing the desired client (**Management/ Manage client parameters**);
- by pressing the appropriate button on the instrument panel 🗑️.

You will receive a confirmation message like the following: "Do you want to delete the brokerage fee parameters for the account ...?". To confirm press **Yes**, to cancel press **No**. The confirmation dialog settings can be specified via the **Confirmation on changing BF and clients parameters**(Settings/ Terminal settings/ Management) option.

8.7. Prohibitions on operations for clients

When working with the trading terminal, you are allowed to add some additional limits on performing the trading operations called prohibitions.

Prohibitions on futures are set separately from that on options.

You can set more than one prohibition for a same client code at once.

In case you have a general prohibition and a particular prohibition set for the same client, the particular prohibition is always prioritized. For example, if you have set a general prohibition on opening positions for all clients, you are can to specify some client codes allowed to open positions.

Upon adding a new order, the system verifies if there are prohibitions had been set. In case of prohibition on adding the order, the trading system returns an appropriate message.

By default, all traders are allowed to set prohibitions to their clients. If you need to restrict the trader's rights for setting prohibition, you should apply to the trading system administrator.

Prohibitions are displayed in the **Prohibitions** (main menu item **Management**) window:

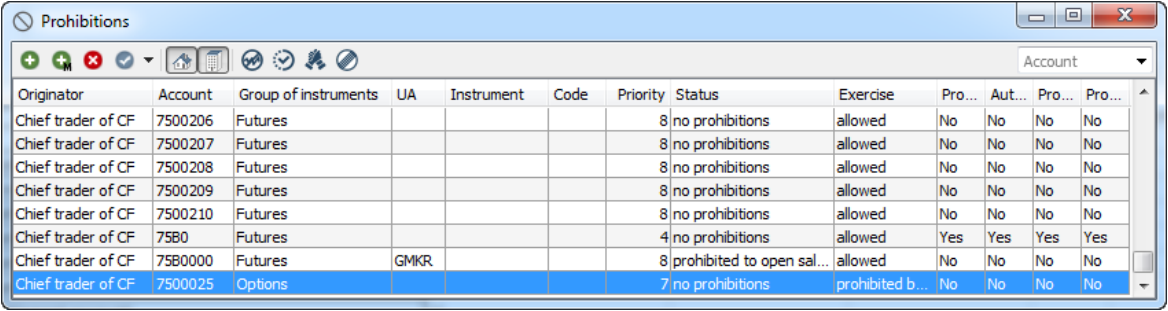

Originator	Account	Group of Instruments	UA	Instrument	Code	Priority	Status	Exercise	Pro...	Aut...	Pro...	Pro...
Chief trader of CF	7500206	Futures				8	no prohibitions	allowed	No	No	No	No
Chief trader of CF	7500207	Futures				8	no prohibitions	allowed	No	No	No	No
Chief trader of CF	7500208	Futures				8	no prohibitions	allowed	No	No	No	No
Chief trader of CF	7500209	Futures				8	no prohibitions	allowed	No	No	No	No
Chief trader of CF	7500210	Futures				8	no prohibitions	allowed	No	No	No	No
Chief trader of CF	75B0	Futures				4	no prohibitions	allowed	Yes	Yes	Yes	Yes
Chief trader of CF	75B0000	Futures	GMKR			8	prohibited to open sal...	allowed	No	No	No	No
Chief trader of CF	7500025	Options				7	no prohibitions	prohibited b...	No	No	No	No

Fig. 8.26. Window Prohibitions

Tab. 8.20. Parameters in the Prohibitions window











Parameter	Details
Code	Instrument code Instruments are grouped separately by futures and options. Among each group, the instruments are grouped by UA, then by particular instruments The * flag means that the prohibition is extended to all instruments in the group (futures or options).
Instrument	Instrument code
Rule	Rule number - set automatically
Account	Client account under the prohibition
Originator	Originator of prohibition (indicates whether it is allowable to cancel the prohibition): BF, chief trader of CF, TS administrator
Section	Stock market section under the prohibition: <ul style="list-style-type: none"> • money; • stock; • commodities.
UA	Underlying asset code
Priority	Prohibition priority. The bigger the number, the higher the priority
Mask	Instrument type bitmask
Status	Prohibition type: <ul style="list-style-type: none"> • no prohibitions; • all trading operations are prohibited; • prohibited to open positions; • prohibited to open sale positions.
Compatibility	Flag of previous prohibition mode
Exercise	Prohibited to add orders for option exercise: <ul style="list-style-type: none"> • allowed - exercise is allowed; • prohibited - exercise is prohibited.
Prohibition on requesting of liquidity stream (RFS)	Prohibition on opening of a new liquidity stream
Auto-confirmation (RFS)	Prohibition of requests without auto-confirmation
Prohibition of uncompetitive trades (RFS)	Prohibition of performing trades with insufficient number of liquidity provider. The minimum possible number of liquidity providers is set by the trading administrator.
Prohibition of speed limit (RFS)	Prohibition of limiting the minimum life time for quotes

By using the **Prohibitions** window, you can do all available operations via the context menu items or the instrument panel buttons - see section 8.7.1.

You can sort the records in the **Prohibitions** window by every parameters, separately for options and futures group. You can change the sorting direction by clicking the column header with the left mouse button.

8.7.1. Toolbar of the Prohibitions window

Tab. 8.21. Toolbar of the Prohibitions window

Icon	Context menu item	Details
	Add prohibition	Opens the prohibition adding window - see section 8.7.2.
	Add group of prohibitions	Opens the group of prohibition adding window - see section 8.7.3.
	Remove prohibition	Request to remove prohibitions - see section 8.9.
	Status	Opens the list of prohibitions, where you can add a new prohibition in a fast way - see section 8.7.4.
	Brokerage Firm prohibition on adding orders to exercise/ non-exercise option contracts	Adds BF prohibition on option exercising - see section 8.7.5. By non-exercise we mean denial of automatic exercise in-the-money options.
	Chief Trader's prohibition on adding orders to exercise / non-exercise option contracts	Adds CF prohibition on option exercising - see section 8.7.5. By non-exercise we mean denial of automatic exercise in-the-money options.
Prohibitions for RFS		
	Prohibition on requesting of liquidity stream (RFS)	Adds/ removes a prohibition in the row under the cursor
	Prohibition of requests without auto-confirmation (RFS)	Adds/ removes a prohibition in the row under the cursor
	Prohibition of performing trades with insufficient number of liquidity provider (RFS)	Adds/ removes a prohibition in the row under the cursor
	Prohibition of limiting the minimum life time for quotes (RFS)	Adds/ removes a prohibition in the row under the cursor

8.7.2. Setting prohibitions for operations

You can set prohibitions by the following methods:

- via the **Add prohibition** context menu item, opened on the **Prohibitions** window;
- by pressing the appropriate button on the local toolbar  ;
- via the appropriate context menu items, by checking or unchecking the box to the left of the menu item to prohibit the adding option exercising orders and prohibitions for RFS;
- by the appropriate buttons of the local toolbar, pressing or unpressing them (if the button is pressed) to prohibit the adding option exercising orders and prohibitions for RFS.

Prohibitions can be set in any combination.

To set prohibitions on operations, you should use the special form:

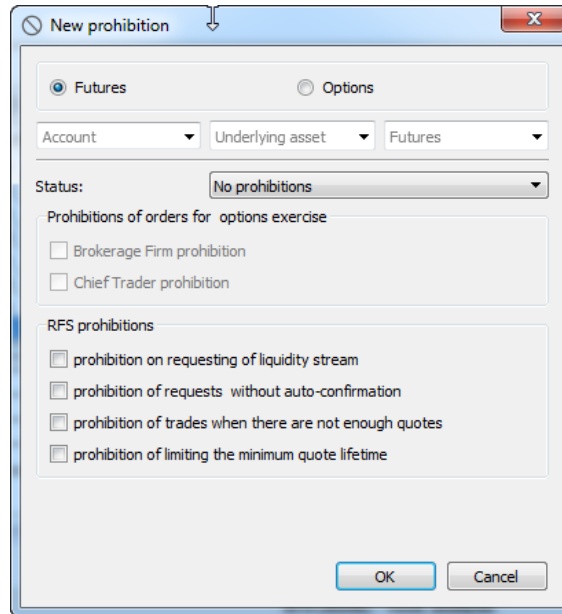

Fig. 8.27. Setting prohibitions on operations

Tab. 8.22. Parameters in the New prohibition window

Parameter	Details
Futures or Options	Specifies the instrument type to set the prohibition on: <ul style="list-style-type: none"> • futures (by default); • options.
Account	Client account code, can be selected in the drop-down list.
Underlying asset	Underlying asset code, can be selected in the drop-down list.
Futures	The futures code, used to set the prohibition for the selected account. You can select a futures code in the drop-down list according to the underlying asset. The Underlying asset field will be filled in automatically after selecting a futures.
Status	Prohibition type: <ul style="list-style-type: none"> • no prohibitions; • all trading operations are prohibited; • prohibited to open positions; • prohibited to open sale positions.
Prohibitions of orders for options exercise	
Brokerage Firm prohibition	Prohibition is set by BF to add option exercise/ non-exercise orders - see section 8.7.5. Non-exercise - refusal of automatic execution in money.
Chief Trader prohibition	Prohibition is set by CT to add option exercise/ non-exercise orders - see section 8.7.5. Non-exercise - refusal of automatic execution in money.
RFS prohibitions	

Parameter	Details
prohibition on requesting of liquidity stream	Prohibition on opening of a new liquidity stream. The flag is set - the liquidity consumer cannot open a new liquidity stream. The flag is not set - the liquidity consumer can open a new liquidity stream.
prohibition of requests without auto-confirmation	Flag is set - the liquidity consumer can open liquidity streams only with the flag of auto-confirmation for the provider quotes. Flag is not set - LC can add a request for a stream with or without an auto-confirmation flag.
prohibition of trades when there are not enough quotes	The flag is set - it is impossible to make a trade if there are not enough quotes from liquidity providers. The minimum possible number of providers is determined by the trading system administrator. The flag is not set - a trade can be made with any number of quotes from liquidity providers.
prohibition of limiting the minimum quote lifetime	The flag is set - LC cannot limit the minimum life time of quotes provider in a request for stream. The flag is not set - LC can limit the minimum life time of quotes provider in a request for stream.

Press **OK** to confirm, or **Cancel** to undo all changes.

8.7.3. Setting group of prohibitions

A group of prohibitions means the same prohibition applied to more than one client accounts for more than one instruments at once.

You can set prohibitions by the following methods:

- via the **Add group of prohibitions** context menu item, opened on the **Prohibitions** window;
- by pressing the appropriate button on the instrument panel .

To set prohibitions on operations, you should use the special form:

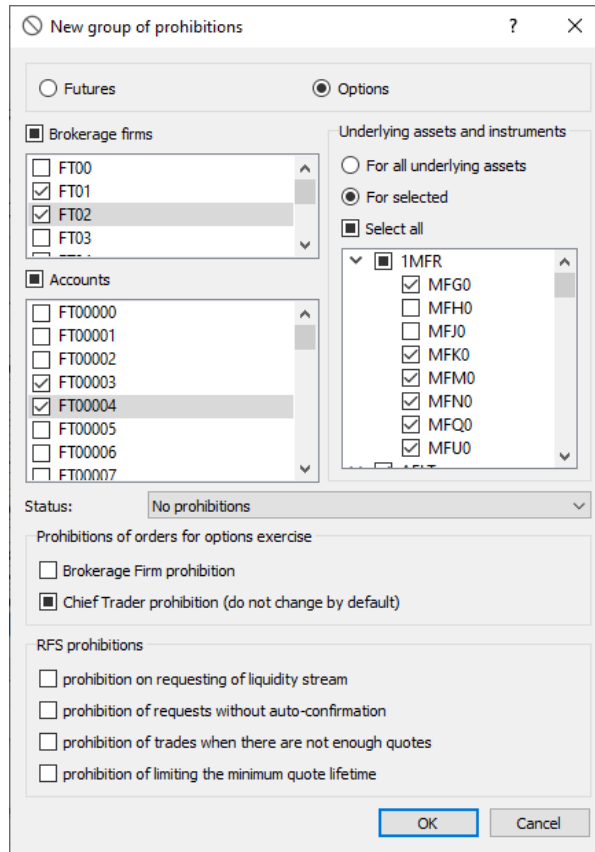

Fig. 8.28. Setting group of prohibitions

Tab. 8.23. Parameters in the New group of prohibitions window

Parameter	Details
Futures or Options	Specifies the instrument type to set the prohibition on: <ul style="list-style-type: none"> • futures (by default); • options.
Brokerage firms	BF codes. A check mark is set for those BFs for which a prohibition group will be valid.
Accounts	Clients accounts codes. The ticked accounts are subject to the selected set of prohibitions.
Underlying assets and instruments	Underlying assets codes or instruments codes, can be selected in the drop-down list. The ticked instruments are subject to the selected set of prohibitions. To tick all instruments of the same underlying asset, simply tick the underlying asset itself. You can select all instruments at once by setting the Select all option The switch allows you to specify the selection: <ul style="list-style-type: none"> • For all underlying assets - prohibitions will be set for all underlying assets. In this case, the selection of instruments is not available; • For selected - prohibitions will be set for selected instruments.

Parameter	Details
Status	Prohibition type: <ul style="list-style-type: none"> • no prohibitions; • all trading operations are prohibited; • prohibited to open positions; • prohibited to open sale positions.
Prohibitions of orders for options exercise	
Brokerage Firm prohibition	Prohibition is set by BF to add option exercise/ non-exercise orders - see section 8.7.5. Non-exercise - refusal of automatic execution in money.
Chief Trader prohibition	Prohibition is set by CT to add option exercise/ non-exercise orders - see section 8.7.5. Non-exercise - refusal of automatic execution in money. Possible values: <ul style="list-style-type: none"> • by default, a square is displayed in the checkbox - prohibitions that are set by a CF that is not the Chief Trader. The status of such a prohibition will be displayed as a Chief Trader's prohibition; • flag is set - Chief Trader's prohibition; • flag is not set - lack of Chief Trader's prohibition. Changing the option value is done by left-clicking on the checkbox.
RFS prohibitions	
prohibition on requesting of liquidity stream	Prohibition on opening of a new liquidity stream. The flag is set - the liquidity consumer cannot open a new liquidity stream. The flag is not set - the liquidity consumer can open a new liquidity stream.
prohibition of requests without auto-confirmation	Flag is set - the liquidity consumer can open liquidity streams only with the flag of auto-confirmation for the provider quotes. Flag is not set - LC can add a request for a stream with or without an auto-confirmation flag.
prohibition of trades when there are not enough quotes	The flag is set - it is impossible to make a trade if there are not enough quotes from liquidity providers. The minimum possible number of providers is determined by the trading system administrator. The flag is not set - a trade can be made with any number of quotes from liquidity providers.
prohibition of limiting the minimum quote lifetime	The flag is set - LC cannot limit the minimum life time of quotes provider in a request for stream. The flag is not set - LC can limit the minimum life time of quotes provider in a request for stream.

In the entry form, you can turn on and off highlight option for all BF and client accounts at once. To do this, you should add or remove the appropriate flags in the fields above the accounts and BF lists.

Press **OK** to confirm, or **Cancel** to undo all changes.

8.7.4. Change prohibition

You can change existing prohibitions by selecting an appropriate record in the **Prohibitions** window. There are several ways to do this:

- via the **Status** context menu item opened in the right side of the window;
- by pressing the appropriate button in the local instrument panel .

After that, the list of available prohibitions will appear on the screen. You should select a new prohibition in the list and click it with the left mouse button.

You can set/ remove prohibitions for the adding option exercising orders or for RFS:

- via the appropriate context menu items, by checking or unchecking the box to the left of the menu item - see section 8.7.5.;
- by the appropriate buttons of the local toolbar, pressing or unpressing them (if the button is pressed) - see section 8.7.6.

Upon changing the prohibition, the warning message will appear on the screen: "*Are you sure you want to change the prohibition ...?*". Press **Yes** to confirm, or **No** to cancel.



8.7.5. Prohibitions on adding option exercising orders

You can set prohibition on adding option exercising orders for client accounts. The prohibition can be set by BF and CF (Chief Trader). These both prohibitions can be set simultaneously for the same client.

The CF prohibition has the higher priority rate than that of BF. Therefore, BF prohibition does not cover CF, and can be removed by CF, while the CF prohibition does not cover the CF itself and cannot be removed by BF.

Before setting a prohibition, you should select either an account number or a prohibition in the appropriate list.

You can set a prohibition on adding option exercise orders by the following ways:

- from the new prohibition entry form by setting the corresponding prohibitions - see section 8.7.2;
- via the **Brokerage Firm prohibition on adding orders to exercise/ non-exercise option contracts** and **Chief Trader's prohibition on adding orders to exercise / non-exercise option contracts** context menu item;
- by pressing the  and  buttons of the local instrument panel, respectively.





Upon setting the prohibition, you will receive the following messages: "*Are you sure you want to set (or cancel) options exercise prohibition by Brokerage Firm?*" or "*Are you sure you want to set (or cancel) options exercise prohibition by CF Chief Trader?*". Press **Yes** to set or remove the prohibition, or **No** to undo changes. The **Confirmation on working with prohibitions (Settings/ Terminal settings/ Management)** option allows to specify the confirmation dialog settings.

8.7.6. Prohibitions for RFS

When opening a new auction upon request, the liquidity consumer enters a request for liquidity stream, to which special prohibitions may be applied.

RFS prohibitions can be set in several ways:

- from the new prohibition entry form by setting the corresponding prohibitions - cm. section 8.7.2;
- via the appropriate context menu items:

- **Prohibition of requests without auto-confirmation (RFS);**
 - **Prohibition on requesting of liquidity stream (RFS);**
 - **Prohibition of performing trades with insufficient number of liquidity provider (RFS);**
 - **Prohibition of limiting the minimum life time for quotes (RFS).**
- by buttons of the local instrument panel , ,  and , respectively.

You can both establish a prohibition and remove it by repeating the action.

Upon setting the prohibition, you will receive the following messages: "Are you sure you want to set (remove) the prohibition?". Press **Yes** to set (remove) the prohibition, or **No** to undo changes. The **Confirmation on working with prohibitions**(Settings/ Terminal settings/ Management) option allows to specify the confirmation dialog settings.

8.8. Option exercise rules

The option exercise rules (see section 7.2.2) are displayed in the **Option exercise rules** window (main menu **Management/ Option exercise rules**):

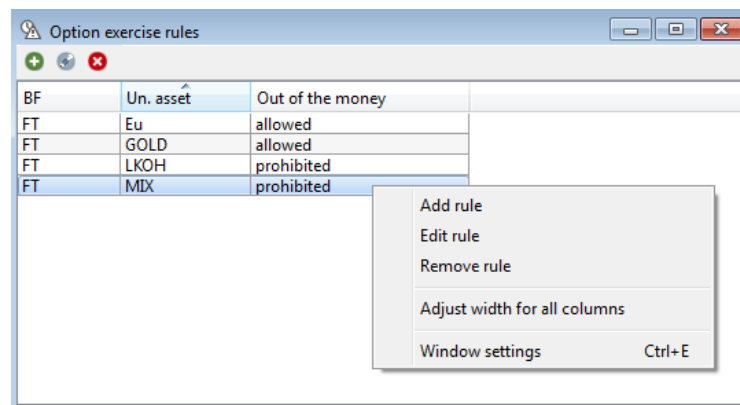

Fig. 8.29. Option exercise rules



Each rule either allows or prohibits exercising out-of-the-money option contracts for a particular underlying asset for a particular Brokerage Firm.

Tab. 8.24. Parameters in the *Option exercise rules* window

Parameter	Description
BF	Brokerage firm code.
Un. asset	Underlying asset. If there is no particular underlying asset code specified, than all underlying assets are subject to the rule.
Out of the money	Allowance of out of the money exercise: <ul style="list-style-type: none"> • allowed; • prohibited.

By using the **Option exercise rules** window, you can do the following operations via the context menu items or the instrument panel buttons:



- **Add rule** –  - see section 8.8.2;

- **Edit rule** -  - the same exercising rule adding form (see section 8.8.2) will appear on the screen. Please note, that you cannot change the **Underlying asset** field value;
- **Remove rule** -  - see section 8.9.

You can sort records in the **Option exercise rules** window by any column in any direction. To change the sorting direction, click a column header with the left mouse button. The column header then will be marked in light-blue colour, and a small arrow will appear, which shows the sorting direction.

8.8.1. Toolbar in the Option exercise rules window

Tab. 8.25. Toolbar in the Option exercise rules window

Icon	Context menu command	Details
	Add rule	Opens the rule adding window - see section 8.8.2.
	Edit rule	Opens the adding rule window. The Underlying asset field value cannot be changed - see section 8.8.2.
	Remove rule	Opens the rule removing window - see section 8.9.

8.8.2. Setting a new options exercise rule

You can set new option exercise rules by the following methods:

- via the **Add rule** context menu item opened in the right side of the window;
- by pressing the  button on the local instrument panel.

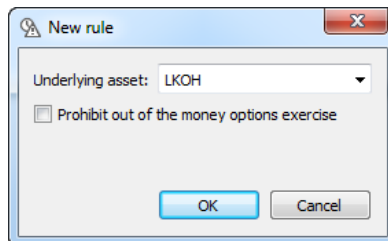



Fig. 8.30. Setting a new options exercise rule

Tab. 8.26. Parameters in the New rule window

Parameter	Details
Underlying asset	The underlying asset code to set the exercise rule for. Can be selected in the drop-down list. If there is no particular underlying asset code specified, than all underlying assets are subject to the rule.
Prohibit out of the money options expiration	When on, it is prohibited to exercise the out of the money options. When off, the exercise the out of the money options is available.

Upon adding a new rule, you will receive a confirmation message like the following: "Are you sure you want to set the automatic option exercise rule?". To confirm press **Yes**, to cancel press **No**. The confirmation dialog settings can be specified via the **Confirmation on working with fulfilment rules (Settings/ Terminal settings/ Management)** option.



When you add a new rule for the BF account - underlying asset pair, the previously added rule will be replaced by the new one.

The already existing rules can be edited via the **Edit rule** context menu item or by pressing the  button on the local instrument panel. Please note, that you will not be able to edit the **Underlying asset** field value.

8.9. Removing limits, prohibitions and rules

After removing a limit, the account will not be verified while adding an order, i.e. no limits will be applied to this account.

You can remove limits by the following methods:

- via the context menu item, when the context menu was opened from the account records you want to remove limit/prohibition/rule for: **Remove limits** (in the **Limitation** window), **Remove prohibition** (in the **Prohibitions on operations** window), **Remove rule** (in the **Option exercise rules** window);
- by pressing the buttons on the local instrument panel:  (general limits),  (prohibitions, exercise rules).

Upon adding a new rule, you will receive a confirmation message like the following: "Are you sure you want to remove all client limits for account ...?" or "Are you sure you want to remove the rule...?". To confirm press **Yes**, to cancel press **No**.

You can disable the confirmation message by activating the **Do not show next time** option in the removing window. To put the confirmation message back you should use the **Confirmation on working with fulfilment rules/ limits/ prohibitions** option via the **Settings/ Terminal settingsMOEX Spectra Terminal/ Preferences/** main menu item, the **Management** section.

8.10. Users

Window **User** allows to activate/deactivate Trading participants' logins along with or without canceling their orders. The window can be opened via the main menu item **Management/ Users**.

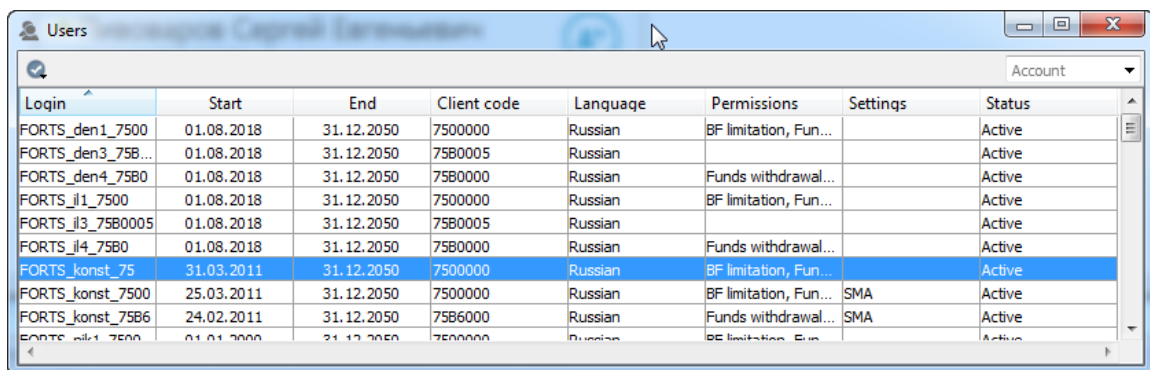

Login	Start	End	Client code	Language	Permissions	Settings	Status
FORTS_den1_7500	01.08.2018	31.12.2050	7500000	Russian	BF limitation, Fun...		Active
FORTS_den3_75B...	01.08.2018	31.12.2050	75B0005	Russian			Active
FORTS_den4_75B0	01.08.2018	31.12.2050	75B0000	Russian	Funds withdrawal...		Active
FORTS_jl1_7500	01.08.2018	31.12.2050	7500000	Russian	BF limitation, Fun...		Active
FORTS_jl3_75B0005	01.08.2018	31.12.2050	75B0005	Russian			Active
FORTS_jl4_75B0	01.08.2018	31.12.2050	75B0000	Russian	Funds withdrawal...		Active
FORTS_konst_75	31.03.2011	31.12.2050	7500000	Russian	BF limitation, Fun...		Active
FORTS_konst_7500	25.03.2011	31.12.2050	7500000	Russian	BF limitation, Fun...	SMA	Active
FORTS_konst_75B6	24.02.2011	31.12.2050	75B6000	Russian	Funds withdrawal...	SMA	Active
FORTS_kl1_7500	01.01.2000	31.12.2050	7500000	Russian	BF limitation, Fun...		Active

Fig. 8.31. Users

Tab. 8.27. Parameters in the Users window

Parameter	Details
Login	Trading participant's login
Start	Login start date
End	Login end date
Client code	Client code
Language	Message language code

Parameter	Details
Permissions	Action reppmission
Settings	Possible values: <ul style="list-style-type: none"> • SMA - Sponsored Member Access • CoD - Cancel on Disconnect • CoDCD - Cancel on DropCopy Disconnect
Status	Login status <p>Possible values:</p> <ul style="list-style-type: none"> • Active • Inactive • Inactive, cancel orders

To change a login status:

- click the appropriate button on the local instrument panel ;
- in context menu **Status**, select a desirable status in the drop-down menu.

To change a login status, a user has to obtain the appropriate rights. Before changing a login status, a confirmation window appears on the screen. To disable/enable the confirmation please use the setting **Confirmation on user activation/deactivation (Settings/ Terminal settings/ section Management)**.

You can arrange records in the table by any column in both directions. To switch between directions, click the left mouse button on a column header.

In the **Users** window, you can set filtering by account number. You can enter the account number (client code) into the field above the table (**Account**) manually or select it from the drop-down list. The number is case sensitive! Please note that when you enter an account number manually, it is necessary to enter symbols one by one, starting from the very first one. Entering symbols in any other order, e.g. starting from one in the middle of the number, will not result in any search action. Please also note, a symbol which does not belong to any account number will not be displayed in the entry field.

8.11. SMA-user order verification

Window **SMA-user order verification** allows to display and edit verification rules for SMA users orders. To open the window please use the main menu item **Management/ SMA-user order verification**.

The specified rule will be applied on reaching the threshold value (**Value**); after that, the SMA-user order will not be allowed for trading.

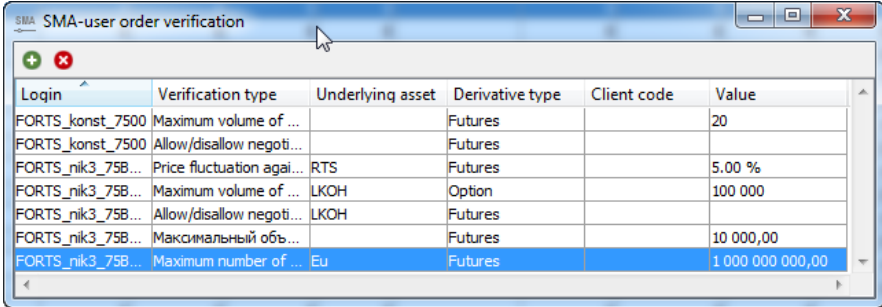

Login	Verification type	Underlying asset	Derivative type	Client code	Value
FORTS_konst_7500	Maximum volume of ...		Futures		20
FORTS_konst_7500	Allow/disallow negoti...		Futures		
FORTS_nik3_75B...	Price fluctuation agai...	RTS	Futures		5.00 %
FORTS_nik3_75B...	Maximum volume of ...	LKOH	Option		100 000
FORTS_nik3_75B...	Allow/disallow negoti...	LKOH	Futures		
FORTS_nik3_75B...	Максимальный объ...		Futures		10 000,00
FORTS_nik3_75B...	Maximum number of ...	Eu	Futures		1 000 000 000,00

Fig. 8.32. SMA-user order verification

Tab. 8.28. Parameters in SMA-user order verification window

Parameter	Details
Login	Trading participant's login (SMA-user)
Verification type	Verification type: <ul style="list-style-type: none"> • Price fluctuation in order against the current price, in percent • Maximum volume of order, in contracts • Allow/disallow negotiated mode • Maximum volume of order, in base currency • Maximum number of orders (gross) allowed per trading day • Maximum position (long) in contracts • Maximum position (short) in contracts
Underlying asset	Underlying asset under verification
Derivative type	Derivative type: <ul style="list-style-type: none"> • futures • option • calendar spread
Client code	Client code under verification
Value	Value under verification

To add a new verification rule, please use the dedicated window (see section 8.11.1). To open the window:

- click context menu item **Add verification**;
- click the local instrument panel button .

Note that you can add only 1 verification rule at once. For adding another verification rule, you should open the window anew.

To delete an existing verification rule, you can use either the context menu item **Delete verification**, or button  of the local instrument panel. Note that you should select a rule to delete with the mouse cursor first!

You can arrange records in the table by any column in both directions. To switch between directions, click the left mouse button on a column header.

8.11.1. Add SMA-user pre-trade verification

To set pre-trade verification rules, please use window **Add SMA-user pre-trade verification**. To open the window:

- use **Add verification** context menu item;
- click the button  of the local instrument panel.

All mandatory fields are highlighted in red. Note that you are unable to save the rule details before all the mandatory fields are completed.

Fig. 8.33. Add SMA-user pre-trade verification

Tab. 8.29. Parameters in Add SMA-user pre-trade verification window

Parameter	Detail
Login	Trading participant's login (SMA-user), can be selected in the drop-down list.
Verification type	<p>Verification type:</p> <ul style="list-style-type: none"> • Price fluctuation in order against the current price, in percent • Maximum volume of order, in contracts • Allow/disallow negotiated mode • Maximum volume of order, in base currency • Maximum number of orders (gross) allowed per trading day • Maximum position (long) in contracts • Maximum position (short) in contracts <p>Please note that you can select only one rule at once. To select a rule, click it with the left mouse button.</p>
Underlying asset code	<p>Underlying asset under verification, can be selected in the drop-down list.</p> <p>Please note that the field may be unavailable for some types of verification.</p>
Derivative type	<p>Derivative type:</p> <ul style="list-style-type: none"> • futures • option • calendar spread
Client code	Client code under verification, can be selected in the drop-down list.

Parameter	Detail
	Please note that the field may be unavailable for some types of verification.
Value	Verification value (threshold value). To enter the value, please use keyboard.

Upon adding a new rule, you will receive a confirmation message like the following: "Are you sure you want to set verification ... user ...?". To confirm press **Yes**, to cancel press **No**. The confirmation dialog settings can be specified via the **Confirmation on SMA-user order verification (Settings/ Terminal settings/ Management)** option.

8.12. Settlement account assets (clearing)

The settlement account assets (the volume available after clearing session) can be viewed in a dedicated window which can be opened via the main menu item **Management/ Settlement account assets (clearing)**.

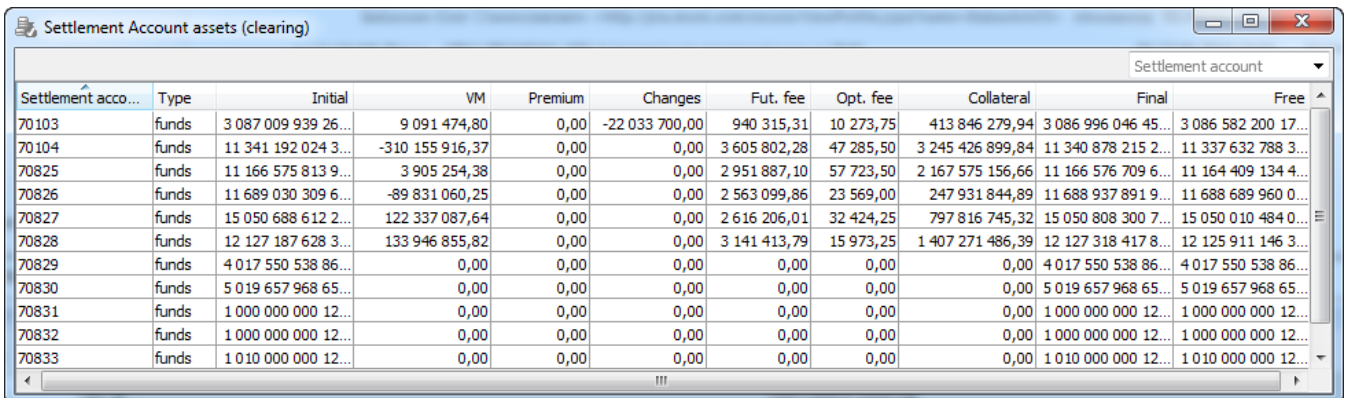

The screenshot shows a window titled "Settlement Account assets (clearing)" with a dropdown menu set to "Settlement account". The table below represents the data shown in the window:

Settlement acco...	Type	Initial	VM	Premium	Changes	Fut. fee	Opt. fee	Collateral	Final	Free
70103	funds	3 087 009 939 26...	9 091 474,80	0,00	-22 033 700,00	940 315,31	10 273,75	413 846 279,94	3 086 996 046 45...	3 086 582 200 17...
70104	funds	11 341 192 024 3...	-310 155 916,37	0,00	0,00	3 605 802,28	47 285,50	3 245 426 899,84	11 340 878 215 2...	11 337 632 788 3...
70825	funds	11 166 575 813 9...	3 905 254,38	0,00	0,00	2 951 887,10	57 723,50	2 167 575 156,66	11 166 576 709 6...	11 164 409 134 4...
70826	funds	11 689 030 309 6...	-89 831 060,25	0,00	0,00	2 563 099,86	23 569,00	247 931 844,89	11 688 937 891 9...	11 688 689 960 0...
70827	funds	15 050 688 612 2...	122 337 087,64	0,00	0,00	2 616 206,01	32 424,25	797 816 745,32	15 050 808 300 7...	15 050 010 484 0...
70828	funds	12 127 187 628 3...	133 946 855,82	0,00	0,00	3 141 413,79	15 973,25	1 407 271 486,39	12 127 318 417 8...	12 125 911 146 3...
70829	funds	4 017 550 538 86...	0,00	0,00	0,00	0,00	0,00	0,00	4 017 550 538 86...	4 017 550 538 86...
70830	funds	5 019 657 968 65...	0,00	0,00	0,00	0,00	0,00	0,00	5 019 657 968 65...	5 019 657 968 65...
70831	funds	1 000 000 000 12...	0,00	0,00	0,00	0,00	0,00	0,00	1 000 000 000 12...	1 000 000 000 12...
70832	funds	1 000 000 000 12...	0,00	0,00	0,00	0,00	0,00	0,00	1 000 000 000 12...	1 000 000 000 12...
70833	funds	1 010 000 000 12...	0,00	0,00	0,00	0,00	0,00	0,00	1 010 000 000 12...	1 010 000 000 12...

Fig. 8.34. Settlement account assets (clearing)

Tab. 8.30. Settlement account assets (clearing) window parameters

Parameter	Details
Settlement account	NCC Settlement account
Type	Account type: <ul style="list-style-type: none"> • funds • pledges
Initial	Funds on opening
VM	Variation margin, including variation margin for futures-style options
Premium	Option premium
Changes	Account activity
Fut. fee	Exchange fee on futures
Opt. fee	Exchange fee on options
Collateral	Total collateral on futures and options
Final	Funds amount on closing
Free	Free assets

You can arrange records in the table by any column in both directions. To switch between directions, click the left mouse button on a column header.

In the **Settlement account assets (clearing)** window, you can set filtering by account number. You can enter the account number into the field above the table (**Settlement account**) manually or select it from the drop-down list.

The number is case sensitive! Please note that when you enter an account number manually, it is necessary to enter symbols one by one, starting from the very first one. Entering symbols in any other order, e.g. starting from one in the middle of the number, will not result in any search action. Please also note, a symbol which does not belong to any account number will not be displayed in the entry field.

8.13. Client assets (clearing)

The client assets (the volume available after clearing session) can be viewed in a dedicated window which can be opened via the main menu item **Management/ Client assets (clearing)**.

Account	Type	Initial	VM	Premium	Changes	Fut. fee	Opt. fee	Collateral	Final	Free
FT00000	funds	1 086 180 888 68...	0,00	0,00	-22 033 70...	0,00	0,00	0,00	1 086 158 854 98...	1 086 158 854 98...
FT00000	pledges	0,00	0,00	0,00	0,00	0,00	0,00	0,00	0,00	0,00
FT00001	funds	1 000 674 017 22...	11 937 0...	0,00	0,00	473 713,05	3 293,25	267 682 419,92	1 000 685 477 31...	1 000 417 794 89...
FT00001	pledges	0,00	0,00	0,00	0,00	0,00	0,00	0,00	0,00	0,00
FT00002	funds	1 000 122 627 43...	-3 069 6...	0,00	0,00	388 857,71	6 504,00	264 385 991,70	1 000 119 162 45...	999 854 776 459,45
FT00002	pledges	0,00	0,00	0,00	0,00	0,00	0,00	0,00	0,00	0,00
FT00003	funds	32 405 922,49	223 999...	0,00	0,00	77 744,55	476,50	3 228 470,31	32 551 700,82	29 323 230,51
FT00003	pledges	0,00	0,00	0,00	0,00	0,00	0,00	0,00	0,00	0,00
FT01000	funds	1 001 211 386 69...	0,00	0,00	0,00	0,00	0,00	0,00	1 001 211 386 69...	1 001 211 386 69...
FT01000	pledges	0,00	0,00	0,00	0,00	0,00	0,00	0,00	0,00	0,00
FT01001	funds	1 013 339 506 15...	27 574 6...	0,00	0,00	353 770,75	1 551,75	465 599 638,27	1 013 366 725 52...	1 012 901 125 88...
FT01001	pledges	0,00	0,00	0,00	0,00	0,00	0,00	0,00	0,00	0,00
FT01002	funds	1 024 754 556 52...	-100 45...	0,00	0,00	403 866,75	5 505,75	1 773 309 214,74	1 024 653 689 12...	1 022 880 379 91...

Fig. 8.35. Client assets (clearing)

Tab. 8.31. Client assets (clearing) window parameters

Parameter	Details
Account	Client code
Type	Account type: <ul style="list-style-type: none"> • funds • pledges
Initial	Funds on opening
VM	Variation margin, including variation margin for futures-style options
Premium	Option premium
Changes	Account activity
Fut. fee	Exchange fee on futures
Opt. fee	Exchange fee on options
Collateral	Total collateral on futures and options
Final	Funds amount on closing
Free	Free assets

You can arrange records in the table by any column in both directions. To switch between directions, click the left mouse button on a column header.

In the **Client assets (clearing)** window, you can set filtering by account number. You can enter the account number into the field above the table (**Account**) manually or select it from the drop-down list. The number is case sensitive! Please note, that you should enter the whole number!

8.14. Collateral breakdown

There are two types of funds exist in the trading system — money and pledges. Pledges are securities or currency accepted by the clearing center as collateral. Share of pledges accepted cannot exceed that of money.

The **Collateral breakdown** contains information about pledges. You can open the window via the **Management/ Collateral breakdown** main menu item. The window is informational and can not perform any actions with pledges, all information in this window is available only for viewing.

Account	Collateral code	Initial	Changes	Current	Value	Initial value	Value change	Current value
4900002	222	-262	0	-262	1,00000	-261,50	0,00	-261,50
4900006	222	-28	0	-28	1,00000	-27,92	0,00	-27,92
4900002	GAZP	1	0	1	133,75000	133,75	0,00	133,75
4900002	URST	1	0	1	1,00000	1,00	0,00	1,00
4900006	SBER	1	0	1	95,27000	95,27	0,00	95,27
4900002	SBER	11	0	11	95,27000	1 047,97	0,00	1 047,97
4900000	GAZP	1 952	0	1 952	133,75000	261 080,00	0,00	261 080,00
4900000	222	186 050	0	186 050	1,00000	186 049,83	0,00	186 049,83

Fig. 8.36. Window Collateral breakdown

Tab. 8.32. Parameters in the Collateral breakdown window

Parameter	Description
Account	Client code.
Collateral code	Foreign currency/ security code.
Initial	Foreign currencies/ securities amount at session opening.
Changes	Amount of foreign currencies/ securities deposited or withdrawn, in units.
Current	Current amount of foreign currencies/ securities.
Value	Foreign currencies/ securities unit assessed value, in base currency.
Initial value	Foreign currencies/ securities value at session start, in base currency.
Value change	Amount of foreign currencies/ securities deposited or withdrawn, in units, in base currency.
Current value	Current amount of foreign currencies/ securities, in base currency.

You can arrange records in the table by any column in both directions. To switch between directions, click the left mouse button on a column header.

In the **Collateral details** window, you can set filtering by account number. You can enter the account number into the field above the table manually or select it from the drop-down list. The number is case sensitive! Please note, that you should enter the whole number!

8.15. Withdrawal funds from the trading system

You can withdraw funds from the trading system by sending a special electronic request.

To send the funds withdrawal electronic request, please use the **Management/ Requests to deposit/withdraw funds** main menu item. Please note that you cannot withdraw funds by Settlement Accounts of the Unified collateral Pool using the window **Requests to deposit/withdraw funds**.

Please note that you are unable to withdraw assets for Settlement Accounts of Unified Collateral Pool using the window **Requests to withdraw and deposit funds**.

Account	Amount	Time	Mark of Clearin...	Acceptance ti...	Recipient	Settl. Acc.	Bank
FT00001	-1 000,00	15:22:32.817	Removed	15:27:11.100	Тестовая фирма 1	30214810300000...	НКО Расч
FT00002	-100,00	15:22:32.817	Removed	15:27:11.100	Тестовая фирма 1	30214810300000...	НКО Расч
FT01002	-3,00	15:27:04.480	Removed	15:27:11.100	Тестовая фирма 1	30214810300000...	НКО Расч
FT01006	-8,00	15:27:04.480	Removed	15:27:11.100	Тестовая фирма 1	30214810300000...	НКО Расч
FT00000	-150,00	17:08:09.137			Тестовая фирма 1	30214810300000...	НКО Расч
FT00001	-10,00	17:08:09.137			Тестовая фирма 1	30214810300000...	НКО Расч
FT00002	-50,00	17:08:09.137			Тестовая фирма 1	30214810300000...	НКО Расч
FT00001	-10,00	17:08:58.680			Тестовая фирма 1	30214810300000...	НКО Расч

Fig. 8.37. Requests to deposit/withdraw funds

The **Requests to deposit/ withdraw funds** window displays the requests already sent into the system. The list includes both processed and unprocessed requests types.



The requests list displays not only withdrawn funds (negative value), but also deposited amounts (positive value). The funds deposit requests are automatically generated by the trading system; you can view them in the **Requests to deposit/ withdraw funds** window.

Tab. 8.33. Parameters in the Requests to deposit/ withdraw funds window

Parameter	Details
Account	Client account.
Amount	Amount of funds: <ul style="list-style-type: none"> • negative value — withdrawn funds; • positive value — deposited funds.
Time	Withdrawal request time.
Mark of Clearing Center	Request status: <ul style="list-style-type: none"> • none - the request has been sent by user but was not processed by the Clearing Center; • Received - the funds deposit order has been received; • Built - the request has been transferred to the Clearing House; • Accepted - the request has been accepted by the CH; • Not accepted - the request was rejected by the CH; • Executed - the request has been executed; • Recalled by CH - the request has been recalled by the CH; • Cancellation attempt - the trading system attempts to cancel the request according to the user's choice; • Removed - the request was removed. The CH will not process this request.
Acceptance time	The date and time of the last status (accepted/removed/etc.)
Recipient	Recipient of the withdrawing funds
Settl. Acc.	Settlement account to withdraw funds on.
Bank	The receiving bank name.
Corr. Acc.	Correspondent account.
BIC	The receiving bank BIC

Parameter	Details
Recipient's VATIN	The receiving bank VATIN.
Session	Session name.
Type	Operation type: <ul style="list-style-type: none"> • deposit - depositing funds; • withdrawal - withdrawing funds.

By using the **Requests to deposit/ withdraw funds** window, you can do the following operations via the context menu items or the instrument panel buttons:

- **Add withdrawal request** –  - see section 8.15.1;
- **Recall unprocessed requests** -  - see section 8.15.2;

8.15.1. Sending a new withdrawal request

The funds withdrawal request wizard window is available only when a trading session is active (not paused).

To send a new withdrawal request, you should use the **Add withdrawal request** context menu item opened from the **Orders to deposit/ withdraw funds** window or by pressing the  button on the local instrument panel.

The **Withdrawal order wizard** window is used for filling in the request details:

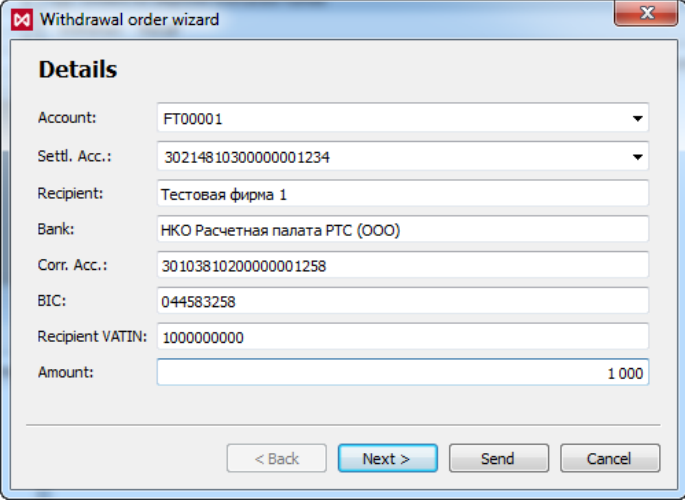

Fig. 8.38. Withdrawal request wizard - Details

On the **Details** page (fig. 8.38), the following fields should be filled in:

- **Account** - client account code to withdraw funds from;
- **Settl. Acc.** - settlement account number to deposit funds on. The **Recipient**, **Bank**, **Corr. Acc.**, **BIC** and **Recipient VATIN** fields will be filled in automatically according to the settlement account number. You cannot edit them manually.
- **Amount** - amount to withdraw.

To proceed with the request press the **Send** button - see fig. 8.38. The request will be sent to the trading system and then displayed in the **Orders to deposit/ withdraw funds** window.

To withdraw funds from more than one client account press the **Next** button - see fig. 8.38. Then, the **Orders** window will appear on the screen:

Account	Amount
FT00001	1 000
FT00002	100

Fig. 8.39. Withdrawal request wizard - Requests

The **Settl. Acc.** field on the **Orders** page displays the account number to deposit funds on. You cannot manually edit this field on this page.

Below is the list of client accounts to withdraw funds from. You can add accounts into the list by specifying the client account number (can be selected from the drop-down list) and amount to withdraw. To confirm adding the account number press the **Add** button (fig. 8.39) right from these fields.

You can remove requests from the list by pressing the **Remove** button (fig. 8.39) right from the list of requests.

By pressing the **Send** button (fig. 8.39), the withdrawal requests will be sent to the trading system. After that, the message appears on the screen: *"The total amount is...Are you sure you want to send this order?"*, containing the total amount to be withdrawn from all specified accounts. Press **Yes** to confirm and send the request; the **Orders to deposit/ withdraw funds** window will renew and display the newly added requests separate for each account. Press **No** to cancel sending the request - you will be taken back to the **Requests** page of the wizard.

By pressing the **Back** button (fig. 8.39) you will be taken back to the **Details** page (fig. 8.38). All the newly entered accounts details will be lost except the account details specified in the **Details** page of the wizard.

8.15.2. Recalling withdrawal request

You can cancel your withdrawal request before it is accepted and processed by the Clearing Center. The unprocessed request has the **Mark of Clearing** and **Acceptance time** fields empty - see fig. 8.37. After the request has been accepted (**Built** status) - you cannot recall it.

You can recall your withdrawal request via the **Orders to deposit/ withdraw funds** window (the **Management** main menu item) by the following ways:

- via the **Recall unprocessed requests** - context menu item;
- by pressing the  button of the local instrument panel.

Please note, that you cannot recall a separate request. If you have several unprocessed requests in the list, they all will be recalled.

When you try to recall a request, a message appears on the screen: *"Are you sure you want to recall all unprocessed orders?"*. Answer **Yes** to recall the requests, or **No** to cancel the recall.

The recalled requests are marked with the **Removed** status.

If you try to recall the orders which have been already processed by the Clearing Center, the message will appear on the screen: "No withdrawal requests to recall".

8.16. Position profiles transfer requests

In order to provide clients with possibility to transfer position profiles via the MOEX Spectra trading terminal into the Unified Customer Database, first, there must be a link registered between a Clearing participant login within the Trading-and-Clearing system, and MOEX Passport ID. The link will be registered according to the application submitted by the Clearing participant, and based on the Information and technical support agreement signed between the Clearing participant and Moscow Exchange. Once such link exists, CA API Gateway will be able to accept outgoing requests from the MOEX Spectra trading terminal, and transmit them into the Clearing terminal via WEB-API.

If such a link for the Clearing participant does not exist, then the functional window **Position profiles transfer requests** will display an error message: 'Error (code=403): Restricted. Client is not permitted to execute request'. Thus, the client will not be able to view any additional details, or make any action within the window.

All position profile transfer requests applied to NCC by a Clearing participant via the WEB-API Clearing terminal, after being verified, will be added into the *List of position profile transfer requests* maintained by the Central Counterparty System. This list can be also transmitted into the trading terminal and displayed in the window **Position profiles transfer requests** - see fig. 8.40.

The window **Position profiles transfer requests** is designated exclusively for Settlement accounts belonging to the Unified Collateral Pool.

To apply a position profile transfer request electronically, please use the main menu item **Management/ Position profiles transfer requests**.

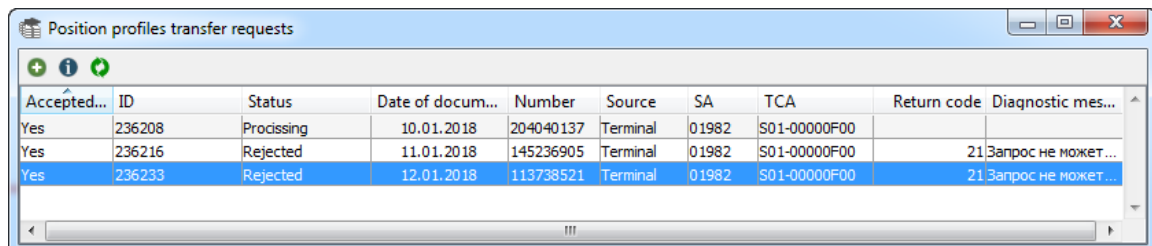

Accepted...	ID	Status	Date of docum...	Number	Source	SA	TCA	Return code	Diagnostic mes...
Yes	236208	Processing	10.01.2018	204040137	Terminal	01982	S01-00000F00		
Yes	236216	Rejected	11.01.2018	145236905	Terminal	01982	S01-00000F00	21	Запрос не может...
Yes	236233	Rejected	12.01.2018	113738521	Terminal	01982	S01-00000F00	21	Запрос не может...

Fig. 8.40. Position profiles transfer requests

The window **Position profiles transfer requests** contains the list of applied requests, both processed and not yet processed.

The list of requests cannot be updated automatically. To update the list manually, please use button  **Update list** of the local instrument panel. The information provided by Central Counterparty System via the Clearing terminal.

Tab. 8.34. Parameters in the Position profiles transfer requests window

Parameter	Details
Accepted by CS	Accepted by CS: <ul style="list-style-type: none"> • Yes • No
ID	Request ID
Status	Document status:



Parameter	Details
	<ul style="list-style-type: none"> • Registered • Processing • Executed • Rejected • Failed to execute
Date of document	Date of position profile transfer request application. Must be the same as clearing date.
Number	Document number. Assigned automatically. The position profile transfer request numbers must be unique within the same date period, and may repeat on different dates.
Source	Source of request: <ul style="list-style-type: none"> • Terminal - for requests applied via the MOEX Spectra trading terminal • Swift - for requests applied via Central Counterparty System
SA	Settlement Account
TCA	TCA of Unified Collateral Pool
Received	Receive time HH:MM:SS
Processed	Time of processing HH:MM:SS
Return code	Return code
Diagnostic message	Diagnostic message

All actions in the window can be executed either by using buttons of the local instrument panel (see section 8.16.1), or via the context menu items:

- **Transfer** - see section 8.16.2;;
- **Details of selected transfer** - see section 8.16.3;;
- **Update list.**

8.16.1. Toolbar of the Position profiles transfer requests window

Tab. 8.35. Toolbar of the Position profiles transfer requests window

Icon	Context menu item	Details
	Transfer	Evokes a window to apply a position profile transfer request - see section 8.16.2.
	Details of selected transfer request	Evokes a window containing all the details concerning the selected transfer request - see section 8.16.3.
	Update list	Updates the list of requests.

8.16.2. Position profiles transfer by asset

To apply a new position profile transfer request, please use the button  **Transfer** of the local instrument panel.

All the transfer details can be entered using the window **Position profiles transfer by asset**:

Market sector	Clearing Account	Asset code	Amount
EQ Фондовый		RUB Российские рубли	-200,00
CU Валютный		RUB Российские рубли	50,00
FU Срочный	7500018	RUB Российские рубли	50,00
FU Срочный	7500025	RUB Российские рубли	100,00

Fig. 8.41. Position profiles transfer by asset

Tab. 8.36. Parameters of the Position profiles transfer by asset

Parameter	Details
Clearing member's ID	<p>Clearing member's ID within the ASTS trading system (Securities Market), the Trading-and-clearing Account of Unified Collateral Pool is registered in.</p> <p>You should select a value using the drop-down list. The values are available via the Clearing terminal.</p>
TCA of Unified Collateral Pool	<p>Trading-and-clearing Account of Unified Collateral Pool in the ASTS trading system (Securities Market)</p> <p>You should select a value using the drop-down list. The values are available via the Clearing terminal. The list of values includes active trading-and-clearing accounts of the given Clearing participant, with the mark of TCA of Unified Collateral Pool.</p>
Settlement Account	<p>Settlement account.</p> <p>The field is filled in automatically.</p>
Market section	<p>Market section. By default, it contains a value for ASTS trading system (Securities market).</p> <p>You should select a value using the drop-down list, containing only the market sections related to the Unified Collateral Pool project:</p> <ul style="list-style-type: none"> • EQ - ASTS (Equity & Bond Market) • CU - ASTS (FX Market) • FU - SPECTRA (Derivatives Market)
Clearing account	<p>ID of clearing account. You can select a value from the drop-down list.</p> <p>Please note that IDs of clearing accounts specified in different records of the same request, may be equal.</p> <p>Derivatives Market - SPECTRA</p> <p>For this market sector, it is mandatory to specify a Clearing account ID as a 7-digit ID of the Clearing account's section. Please note that the IDs of the Clearing accounts</p>

Parameter	Details
	<p>belong to the same Brokerage firm; you are unable to select any ID belonging to another Brokerage firm.</p> <p>FX Market - ASTS</p> <p>For this market sector, it is not obligatory to specify Clearing account IDs. You are able to specify 2nd-level Settlement codes related to the Settlement code specified in the profile transfer request.</p> <p>Equity & Bond Market - ASTS</p> <p>For this market sector, no Clearing account IDs are specified.</p>
Asset code	<p>Asset code of the positions to transfer. The following codes are available:</p> <ul style="list-style-type: none"> • RUB • foreign currency • precious metal • security (ISIN)
Amount	<p>Amount of positions to transfer. This value can be either positive, or negative.</p> <p>For FX, it is prohibited to transfer fractional amounts.</p>

Each transfer transaction is required to contain at least 2 lines:

- amount to withdraw (a negative value);
- amount to deposit (a positive value).

To add a new line, you should fill in all the necessary fields, and then press the button  (see fig. 8.41).

To delete a line, please select it in the list, and then press the button . The button will stay disabled if no line has been selected.

It is possible to transfer assets between the market sectors, or between Clearing accounts. Please note that the Clearing account IDs cannot be the same for donor and recipient. Once such situation occurs, a warning message in red color will appear in the bottom of the form.

Each correct transfer transaction should contain 0 in its column **Amount**. In any other case, the button **Transfer** remains disabled.

To send a transfer request for the complete list into the Trading system, press the button **Transfer** (fig. 8.41). A warning message will appear on the screen: *'Are you sure you want to send the transfer request?'*. Answer **Yes** to confirm sending the request.

Once there is any failure in sending the request, a error message will appear on the screen, along with the same message in the bottom part of the form. In this case, you are advised to correct the data entered, and retry to send the request.

By pressing the button **Cancel**, you will close the current window without saving and/or sending any data.

8.16.3. Position profile transfer request information

To view detailed information on any of the requests, you should select a line in the window **Position profile transfer request** (fig. 8.40), and then press the button  of the local instrument panel.

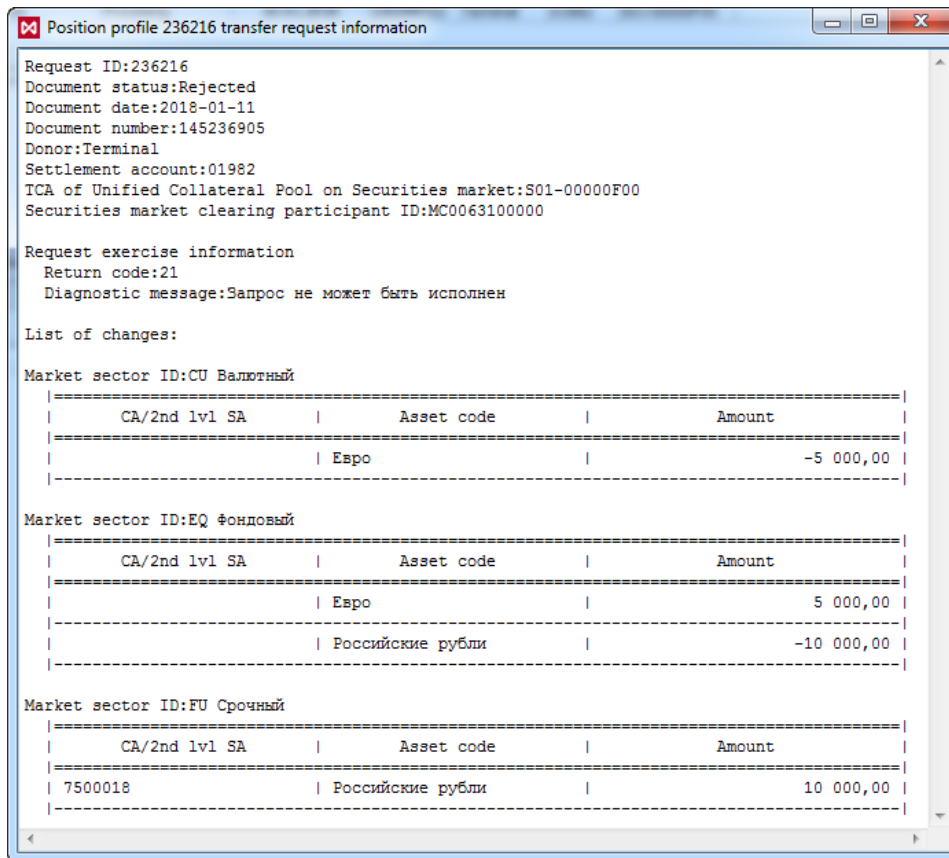

Fig. 8.42. Position profile transfer request information

To know more about parameters of the request, see tab. 8.34.

Along with the general information on the request, the window displays the list of position profile changes related to the given request.

You can open more than one information window at time. It is not necessary to close an already opened window before opening another one.

8.17. Collateral transfer requests

In order to provide clients with possibility to transfer position profiles via the MOEX Spectra trading terminal, first, there must be a link registered between a Clearing participant login within the Trading-and-Clearing system, and MOEX Passport ID. The link will be registered according to the application submitted by the Clearing participant, and based on the Information and technical support agreement signed between the Clearing participant and Moscow Exchange.

If there is no such a link exists for the Clearing participant, then the functional window **Collateral transfer requests** will display an error message: *'Error (code=403): Restricted. Client is not permitted to execute request'*. Thus, the client will not be able to view any additional details, or make any action within the window.

The functional window **Collateral transfer requests** is used to transfer collateral between Settlement accounts or between Markets with in the same Settlement account.

The collateral transfer request is designated exclusively to transfer assets, i.e. Russian rubles, foreign currency and precious metal, between Settlement accounts specified in the request.

To apply a collateral transfer request electronically, please use the main menu item **Management/ Collateral transfer requests**.

Accepted by CS	ID	Status	Date of document	Number	Source	Donor SA	Donor market...	Recipient SA	Recipient market
No	976	Failed to execute	02.10.2017	171123512					
No	1067	Failed to execute	02.10.2017	94401404					
No	1070	Failed to execute	02.10.2017	124942534					
Yes	235777	Processed	02.10.2017	115919350	Terminal	26888	FU Срочный	26888	FU Срочный
Yes	235778	Rejected	02.10.2017	120220999	Terminal	00178	EQ Фондовый	26888	FU Срочный
Yes	235779	Rejected	02.10.2017	124258743	Terminal	00178	EQ Фондовый	26888	FU Срочный
Yes	235784	Processed	09.10.2017	665919350	Terminal	26888	FU Срочный	26888	FU Срочный
Yes	235792	Rejected	02.10.2017	170057842	Terminal	00622	CU Валютный	26888	FU Срочный

Fig. 8.43. Collateral transfer requests

The window **Collateral transfer requests** contains the list of applied requests, both processed and not yet processed.

The list of requests cannot be updated automatically. To update the list manually, please use button  **Update list** of the local instrument panel.

Tab. 8.37. Parameters of the Collateral transfer requests window

Parameter	Details
Accepted by CS	Accepted by CS: <ul style="list-style-type: none"> • Yes • No
ID	Request ID
Status	Document status: <ul style="list-style-type: none"> • Registered • Processing • Executed • Rejected • Failed to execute
Date of document	Date of position collateral transfer request application. Must be the same as clearing date.
Number	Document number. Assigned automatically. The position profile transfer request numbers must be unique within the same date period, and may repeat on different dates.
Source	Source of request: <ul style="list-style-type: none"> • Terminal - for requests applied via the MOEX Spectra trading terminal • Swift - for requests applied via Central Counterparty System
Donor SA	Donor settlement account
Donor market section	Donor market section: <ul style="list-style-type: none"> • EQ - ASTS (Equity & Bond Market) • CU - ASTS (FX Market) • FU - SPECTRA (Derivatives Market)
Recipient SA	Recipient settlement account



Parameter	Details
Recipient market section	Recipient market section: <ul style="list-style-type: none"> • EQ - ASTS (Equity & Bond Market) • CU - ASTS (FX Market) • FU - SPECTRA (Derivatives Market)
Asset code	Asset code
Amount	Amount/quantity of collateral to transfer
Received	Receive time HH:MM:SS
Processed	Time of processing HH:MM:SS
Return code	Return code
Diagnostic message	Diagnostic message
Asset name	Asset full name

All actions in the window can be executed either by using buttons of the local instrument panel (see section 8.17.1), or via the context menu items:

- **Transfer** - see section 8.17.2;
- **Details of selected transfer** - see section 8.17.3;
- **Update list**.

8.17.1. Toolbar of the Collateral transfer requests window

Tab. 8.38. Toolbar of the Collateral transfer requests window

Icon	Content menu command	Details
	Transfer	Evokes a window to apply a collateral transfer request - see section 8.17.2.
	Details on selected transfer	Evokes a window containing all the details concerning the selected transfer request - see section 8.17.3.
	Update list	Updates the list of requests.

8.17.2. Collateral transfer

To apply a new collateral transfer request, please use the button **Transfer**  of the local instrument panel. To fill in the request application, please use the window **Collateral transfer**:

Fig. 8.44. Collateral transfer window

Please note that filling in transfer details is not mandatory, and depends on the selected market sector.

When the market sector selected is ASTS (Equity & Bond Market), NAVIGATOR Trading system, or UROZHAY trading system, the appropriate list of changes of Clearing accounts is not filled in.

Tab. 8.39. Parameters of the Collateral transfer window

Field	Details
Settlement Account (Donor)	Settlement account, to transfer collateral from. You should select a value from the drop-down list..
Market (Donor)	Market sector, to transfer collateral from. The default value relates to ASTS (Equity & Bond Market). You should select a value using the drop-down list: <ul style="list-style-type: none"> • EQ - ASTS (Equity & Bond Market) • CU - ASTS (FX Market) • FU - SPECTRA (Derivatives Market) The donor market sector may be equal to that of the recipient.
Settlement Account (Recipient)	Settlement account to transfer collateral to. You should select a value using the drop-down list.
Market (Recipient)	Market sector, to transfer collateral to. You should select a value using the drop-down list: <ul style="list-style-type: none"> • EQ - ASTS (Equity & Bond Market) • CU - ASTS (FX Market) • FU - SPECTRA (Derivatives Market) The donor market sector may be equal to that of the recipient.

Field	Details
Collateral	Collateral ID to transfer. You should select a value using the drop-down list: <ul style="list-style-type: none"> • RUB • foreign currency • precious metal ID
Clearing account (Donor)	ID of donor Clearing account. You can select a value from the drop-down list. <p>Derivatives Market - SPECTRA</p> For this market sector, it is mandatory to specify a Clearing account ID as a 7-digit ID of the Clearing account's section. Please note that the IDs of the Clearing accounts belong to the same Brokerage firm. <p>FX Market - ASTS</p> For this market sector, it is not obligatory to specify Clearing account IDs. You are able to specify 2nd-level Settlement codes related to the Settlement code specified in the profile transfer request. <p>Equity & Bond Market - ASTS</p> For this market sector, no Clearing account IDs are specified.
Amount (Donor)	Amount of collateral according to each Clearing account specified in the list. This value must be positive only.
Clearing account (Recipient)	ID of recipient Clearing account. You can select a value from the drop-down list. Please note that the rules for selecting Clearing account IDs are equal to that of the donor clearing account - see the detailed description above in this table.
Amount (Recipient)	Amount of collateral according to each Clearing account specified in the list. This value must be positive only.
Total amount (Donor)	Total amount of collateral to transfer related to Clearing accounts. Upon filling in the list of collateral to transfer, the Total amount line will be computed automatically. If the list of collateral to transfer is not filled in, for some reason, the Total amount value should be entered manually.
Total amount (Recipient)	Total amount of collateral to receive related to Clearing accounts . Upon filling in the list of collateral to transfer, the Total amount line will be computed automatically. If the list of collateral to transfer is not filled in, for some reason, the Total amount value should be entered manually.

The total amount to transfer may not be equal to the total amount to receive. In this case, the both **Total amount** lines will be highlighted in red color see fig. 8.44.

Please note that button **Transfer** remains disabled until all the fields in the position transfer request transfer form are filled in with all the necessary data.

You can specify more than one change to a Clearing account in the same request. To add a new change, you should fill in all the necessary fields, and then press the button  (see fig. 8.44). Each change will be displayed as a separate line in the bottom part of the form.

To delete a line, please select it in the list, and then press the button . The button will stay disabled if no line has been selected.

When there is no necessity for filling in the list of changes, you should specify amount to transfer manually in the field **Total amount**.

To send a transfer request for the complete list into the Trading system, press the button **Transfer** (fig. 8.44). A warning message will appear on the screen: *'Are you sure you want to send the transfer request?'*. Answer **Yes** to confirm sending the request.

Once there is any failure in sending the request, an error message will appear on the screen, along with the same message in the bottom part of the form see. In this case, you are advised to correct the data entered, and retry to send the request.

By pressing the button **Cancel** (fig. 8.44), you will close the current window without saving and/or sending any data.

If a selected donor **Clearing account** is a Settlement account of Unified Collateral Pool, and if a donor market sector selected is not FX Market, nor Equity & Bond Market, then, along with transferring assets between Settlement accounts, asset profiles will be also transferred between ASTS (Equity & Bond Market) and SPECTRA (Derivatives market) trading-and-clearing systems. The same rule is applied for the Recipient **Clearing account**, as well.

8.17.3. Collateral profile transfer requests information

To view detailed information on any of the requests, you should select a line in the window **Collateral transfer request** (fig. 8.43), and then press the button  of the local instrument panel.

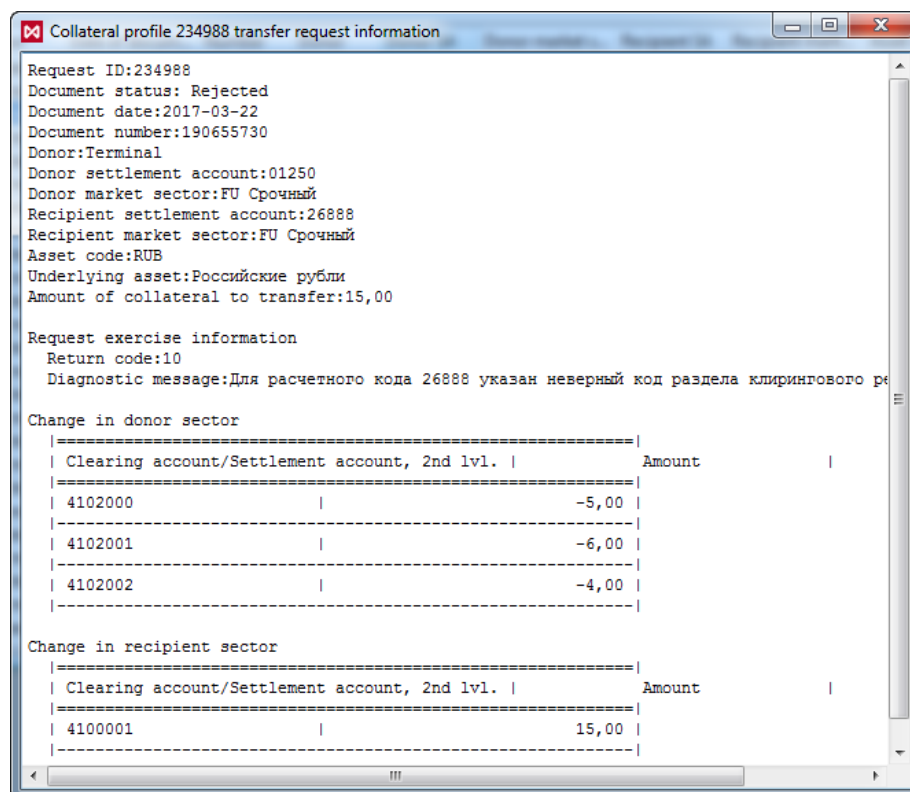

Fig. 8.45. Collateral profile transfer requests information

To know more about parameters of the request, see tab. 8.37.

Along with the general information on the request, the window displays the list of position profile changes related to the given request, if there were any.

You can open more than one information window at time. It is not necessary to close an already opened window before opening another one.

Chapter 9. Technical analysis. Charts.

Technical analysis is a statistical method for analysing market data and using them to forecast the price values. The trade prices are used as raw data: the highest and the lowest price values, opening and closing prices values and the operation volume.

The trading terminal application provides possibilities to receive immediate technical analysis results as graphical charts, which display price trend at every moment of time.

The **Charts and Technical analysis** subsystem is a software plugin, which can be connected via the **Settings/ Terminal settings** menu item of the **Plugins** section by activating the **Tech. analysis** plugin.

All charts are displayed in the separate **Tech. analysis** window – see. section 9.2.

The window may contain more than one graphical chart at once: the main chart and some additional charts (indicators, volume histograms, etc.). A single window may contain charts for different instrument series.

This chapter covers the following information:

- chart types ;
- **Tech. analysis** window;
- charts of series;
- indicators;
- action with charts;
- additional graphic elements;
- object manager;
- indicator editor;
- settings;
- manage TA data .

9.1. Chart types

The time graphical charts has the following characteristics:

- two time parameters – **Range**, to which the displayed data belongs and **TimeFrame** – a time frame value, according to which the graphical data is divided;
- data source – graphical charts display trade prices; the meanings of their values are explained below;
- chart appearance – linear (**Line**), bar (**Bar**) or Japanese Candlestick (**Candle**).

On the time graphical chart, the time axis is divided into some equal time intervals (for example, **TimeFrame**=1 day). Therefore, all market events displayed in the time graphical chart are processed within the **TimeFrame** value. As there are more than one event may happen during the time frame, the graphical chart can contain the following values:

- closing price (**Close**),
- opening price (**Open**),
- highest price (**High**),
- lowest price (**Low**).

The graphical chart can have one of the following appearances:

- linear (**Line**) – for every time frame, there is a closing price point (**Close**) is displayed. The points are connected with line – seefig. 9.1;
- bar (**Bar**), consists of the elements shown at fig. 9.2.
- Japanese Candlestick (**Candle**) consists of the elements shown at fig. 9.3).

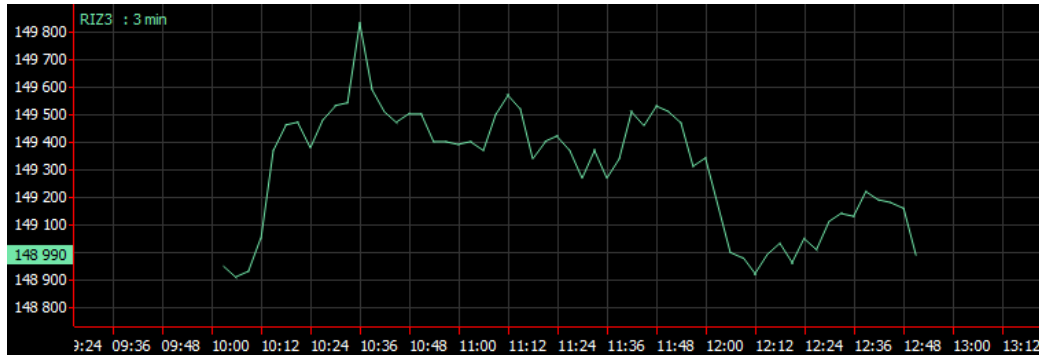

Fig. 9.1. Chart type - Linear

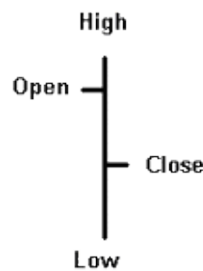

Fig. 9.2. Bar

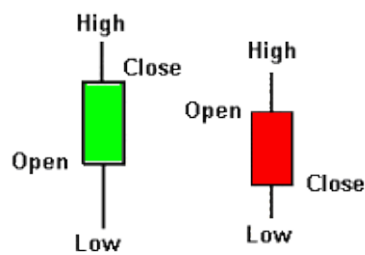

Fig. 9.3. Candles



Fig. 9.4. Chart type - Japanese Candlestick

Depending on correlation between the **Open** and **Close** values, the chart elements (candles) are coloured in different colours: green colour indicates bullish candles, if **Open < Close**; red colour indicates the bearish candles, if **Open > Close**. The neighbouring elements in the bar and candlestick charts are not connected with any line.



Fig. 9.5. Chart type - Bars

9.2. Tech. analysis window

The graphical charts are displayed in the separate **Tech. analysis** window.

You can open the **Tech. analysis** window by the following methods:

- from the **Tech. analysis/ Open chart** main menu;
- by pressing the **Alt+C** key combination;
- from the **All trades/ requests, Your trades/ requests, Your orders/ requests, Financial instruments, Options board, Order-book** windows via the **Open chart** context menu item;
- from the **All trades/ requests** window by double-clicking the left mouse button on the selected instrument;
- from the **Favorite instruments** section of the side panel, via the **Open chart** context menu item.

By default, the **Tech. analysis** window contains the **Volume** indicator, which displays the number of lots/units in each candle .

The window may contain more than one graphical chart at once, i.e. the main chart (series chart) along with some additional charts (indicators) which are superpose the main chart . A single window may contain charts for different instruments which; the charts can be either superposed or opened in the same window, each in its separate area. A single window can contain as many charts and indicators as need be. The time axis in the **Tech. analysis** window is always the same for every chart and indicator.

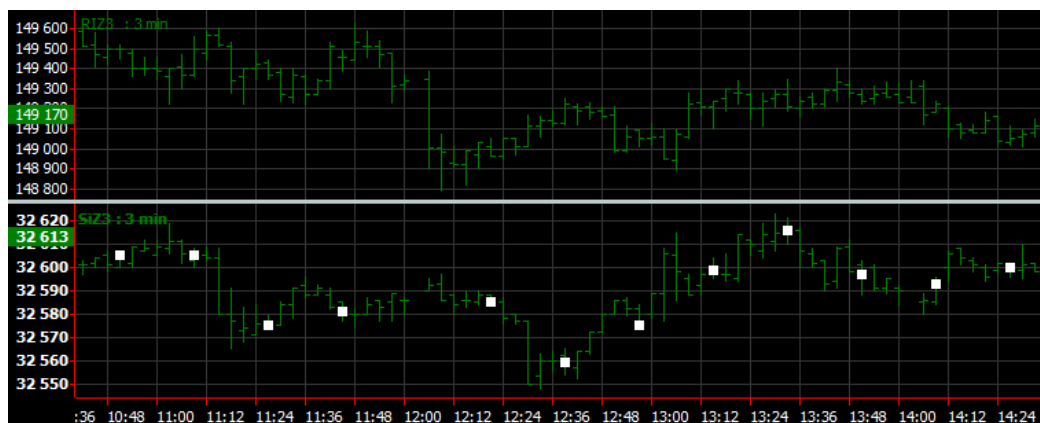

Fig. 9.6. Selected chart in the Tech. analysis window

The X axis always represents time. The time axis is always scaled for every chart displayed in the window.

You can open the context menu by clicking the right mouse button on the time axis. The **Show date** context menu item allows to show the current date below the chart; also; clicking this context menu item again disables the option.

If a chart is too large to fit the open window, you can use the scroll bar in the time axis, which allows to scroll the chart in both directions, right or left.

the vertical axis represents price. Each chart can have its own vertical axis in its own scale. The vertical axes do not correlate to each other. The closing price for a single time frame is dynamically highlighted with a particular colour (the same as the one for the closing price in the chart). You can assign the same vertical axis for more than one chart in the area.

A single area can contain no more than 3 axis by side (3 at the left and 3 at the right). Adding more axis will cause an existing to be removed.

For the **Tech. analysis** window, you can enable the instrument panel by using the appropriate context menu items (see section 9.2.1).

You can select a chart in the window. To do this, click a chart in the window (the mouse cursor will change its shape to hand) or an instrument name in the upper left corner of the window. The selected chart will be marked with squares (see fig. 9.6). You can change some parameters of the selected graph, delete it or drag into another chart section.

Each graphical chart has its own ticker, consisted of two parts: editable and non-editable.

- editable part – either the instrument code or the indicator name, which can be edited – see section 9.5.8. This value is displayed in the chart parameters as **Displayed name**.

When an instrument belongs to the board **Nearby futures contracts**, the nearest futures contract ID is displayed within brackets, next to the instrument ID. For example: **RTS (RIM7)**. Some may find it convenient to control over the most used instruments. For such instruments, the charts ticker will contain a name of the futures contract with the nearby expiration date; once the futures contract expires and be removed from the list, the next futures contract for the same underlying asset will be added, replacing the expired one, and so on.

- non-editable part – time-frame. This part never changes.
- automatically editable part (for indicators) - series code or series chart name (general view). Once you have changed the series chart name in its editable part, this part will change automatically.

To open the **Properties** window for the selected chart, double-click it with the left mouse button.











9.2.1. Toolbar in the Tech. analysis window













In the **Tech. analysis** window, the most frequently used menu items and settings can be put in the instrument panel in the window header area. The instrument panel consists of several parts, where each part can be a separate instrument panel. You can display or hide some panels using the following menu items:









- **'Object management'** toolbar;
- **'View'** toolbar;
- **'H-scale'** toolbar;
- **'V-scale'** toolbar;
- **'Window parameters'** toolbar;
- **'Drowing'** toolbar .

All actions with buttons in the instrument panel affect the selected graphical chart. If there is no chart has been selected, the action will affect a random chart of the series. For example, the highlighted chart type button indicates the selected chart type or a random chart of the same series found in the **Tech. analysis** window (if no chart has been selected).

Tab. 9.1. Toolbar for Tech. analysis

Icon	Hot keys	Details
Object management		
	Ctrl+A	<p>Adds a new series chart.</p> <p>In the drop-down list, you can:</p> <ul style="list-style-type: none"> • select a favorite instrument; • Select Instrument - opens a window (see section 5.11.1) to select an instrument. <p>The graphical chart will be added in the separate area of the Tech. analysis window according to the instrument selected.</p> <p>The time frame value and display time value, the maximum possible values for the current window will be taken.</p>
	Ctrl+Shift+A	Adds anew indicator. Opens the Indicator selection window - see section 9.4.2.
	Ctrl+JCmd+J	Opens the Object manager window – see section 9.7
		Deletes all graphical charts in the current Tech. analysis window.
		Removes all drawings in all areas of the Tech. analysis window.
		Deletes a selected object in the Tech. analysis window: graphical chart, indicator, drawing.
	Ctrl+R	<p>Allows to renew all graphical charts in the Tech. analysis window.</p> <p>This command can be useful, for example, when the time parameters of the session has changed.</p> <p>Please note, that pressing this button will not renew the indicator code in case it has changed. If you notice an indicator name in the chart marked with star, it will mean that the indicator code has been changed. So you should close the indicator and add it anew.</p>
View		
		Switches the chart type to candles.
		Switches the chart type to bars.
		Switches the chart type to line.
		<p>The button allows to switch between the time frame values from the drop-down list. The current value is marked with tick. The recommended (default) value is marked with bold. To set the default value, press the button.</p> <p>The time axis is always adjusted for all charts in the window displayed simultaneously. Therefore, changing time frame value for a single chart will lead to change of all other charts in the window; a chart can be stretched or shrunk horizontally.</p>

Icon	Hot keys	Details
H-scale		
	Ctrl+=	Allows to zoom in the time scale. Charts will be stretched horizontally.
	Ctrl+-	Allows to zoom out the time scale. Charts will be shrunk horizontally.
	Ctrl+0 (zero)	Allows to set the default time scale value.
	Ctrl+Backspace	Pressing the button once will undo the last action you made to the time axis scale. To undo some earlier actions press the button again and again.
		<p>Allows to select a part of a graphical chart and zoom it in in the Tech. analysis window.</p> <p>You can do it in the following way:</p> <ul style="list-style-type: none"> • press the button in the instrument panel; • select a part of the chart (the cursor shape will change automatically). Drag it from the upper left corner to the lower right corner using the left mouse button; • release the left mouse button – the selected chart part will be zoomed in to fit the entire Tech. analysis window.
V-scale		
	Ctrl+F Ctrl+D	<p>Auto-scaling:</p> <ul style="list-style-type: none"> • for screen (Ctrl+F) - the scale is automatically calculated to fit the visible chart values in the visible screen area (vertically); • for the entire series (Ctrl+D) - the scale is automatically calculated to fit all chart values in the visible screen area (vertically).
		Allows to zoom in the Y axis the selected chart. The auto-scaling function will be automatically disabled.
		Allows to zoom in the Y axis the selected chart. The auto-scaling function will be automatically disabled.
		Allows to shift the selected chart and its vertical axis up. The auto-scaling function will be automatically disabled.
		Allows to shift the selected chart and its vertical axis down. The auto-scaling function will be automatically disabled.
Window parameters		
	Ctrl+G	Allows to show/hide grid.
		<p>Allows to show/hide crosshair and values in the axes.</p> <p>The following view modes are available:</p> <ul style="list-style-type: none"> • Crosshair and values (by default) – crosshair and values in both axis are displayed; • Crosshair – only crosshair is displayed; • Values – only values in both axes are displayed;

Icon	Hot keys	Details
		<ul style="list-style-type: none"> • Horizontal line and value – only horizontal line and values in vertical line are displayed; • Vertical line and value – only vertical line and values in horizontal line are displayed. <p>You can select a view mode in the drop-down list by pressing the right side of the button (with arrow). Also, in the drop-down list you can disable a view mode or select another view mode by clicking it with the left mouse button.</p> <p>To turn crosshair on/off simply press the  button. After that, the default view mode will be enabled.</p>
	Ctrl+U	<p>Turns on and off pop-up information message (hint) of the bar closest to the cursor - see fig. 9.7. :</p> <ul style="list-style-type: none"> • date (for example: Date=29.06.2012); • time (for example: Time=10:31:05); • chart/indicator name (for example: RIU2: for series and Close (RIU2): for indicator); • chart indicator info (for example: Close=150); • chart information (the closest bar): <ul style="list-style-type: none"> • O - opening price (Open), • H - highest price (High), • L - lowest price (Low); • C - closing price (Close), • Vol – volume in lots/units; • Val - volume in money. <p>The records in the message are not arranged and displayed randomly. If there are no data, only date and time will be displayed.</p>
Drawing		
		Trend line drawing mode – see section 9.6.1.
		Resistance/support lines drawing mode – see section 9.6.2.
		Fibonacci lines drawing mode – see section 9.6.3.
		Fibonacci arcs drawing mode – see section 9.6.4.
		Fibonacci fan drawing mode – see section 9.6.6.
		Line colour of drawing objects.

Icon	Hot keys	Details
		Please note, that you cannot change colour of the existing objects via the instrument panel. Instead, you should use the Properties option of the object.
	Line width of drawing objects. Please note, that you cannot change line width of the existing objects via the instrument panel. Instead, you should use the Properties option of the object.	

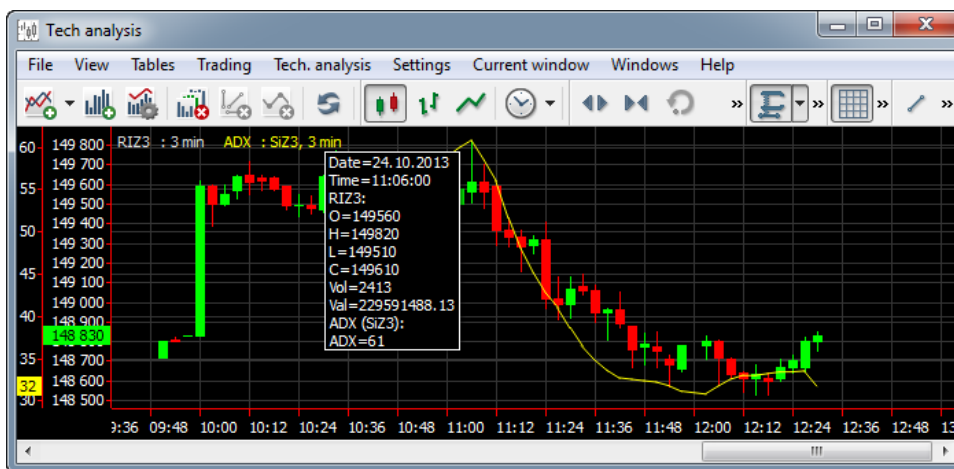

Fig. 9.7. Hint with chart parameters

9.2.2. Context menu in the Tech. analysis window

The context menu of the **Tech. analysis** window contains different menu items depending on different window objects. The standard context menu items are described in Chapter 11. The list below contains the special commands of the **Tech. analysis** window.

The context menu opened from the **Tech. analysis** window contains the following items:

- **Object manager** – opens the **Object manager** window (see section 9.7);
- 'toolbar name' **toolbar** – shows/hides a particular toolbar.

The context menu opened from the chart area of the **Tech. analysis** window contains the following items:

- **Delete** – deletes the current window area including all graphical charts in it. Before deleting, you will receive a confirmation dialog

The context menu opened from the horizontal axis of the **Tech. analysis** window contains the following items:

- **Show date** – shows/hides the current date info below the time axis.

The context menu opened from the vertical axis of the **Tech. analysis** window contains the following items:

- **Show grid** – show/hides horizontal grid for the selected vertical axis. The grid will refer to the scale of the selected axis. Each vertical axis can have its own grid. Please note, that if the  button on the instrument panel is not enabled, no vertical grid will be shown;

- **Grid settings** – allows to set colour for the vertical axis grid. You can specify different colour for each grid;
- **Left** – docks the vertical axis grid to the left side of the window. The vertical axis grid can be displayed at both sides of the window or hidden from the screen;
- **Right** – docks the vertical axis grid to the right side of the window. The vertical axis grid can be displayed at both sides of the window or hidden from the screen;
- **Chart ticker** – for example, **LKZ1. 5 min.** The tick indicates the axis, from which the context menu was opened. The context menu contains names of all axes displayed in the **Tech. analysis** window. To select an axis in the list, click it with the left mouse button; it will substitute the previously active axis. Two equal axes will be displayed as one. To switch the view mode back to display a separate axis, you should set the axis as 'visible' in the chart properties.

The context menu opened from the chart ticker (chart name) contains the following items:

- **Remove** – removes the selected chart. This command also removes all indicators of the selected chart;
- **Properties** – opens the **Instrument chart properties** window (see section 9.3.2). Also, you can open this window simply by double-clicking a chart or a chart ticker with the left mouse button;
- **Hide** – hides a chart in the **Tech. analysis** window, disables the **Visibility** option (see tab. 9.4 and tab. 9.5);
- **Bring to front** – brings the selected chart to the front, overlapping all other charts;
- **Add indicator** – opens the **Indicator selection** window to add an indicator chart;
- **Change instrument** - changes the current instrument and renews all indicator charts added for the previous instrument (see section 9.5.1). If there are several instruments with different exercising dates for one underlying asset (for futures and calendar spreads), then they will be additionally displayed in the context menu;
- **Show errors** - opens a window containing error description. This menu item is available only for erroneous charts (these charts are indicated with the crossed chart ticker name).

The following parameters will be saved by default after saving the **Tech. analysis** window configuration (the **Current window/ Save by default** main menu item) :

- window size;
- grid view settings;
- current date stamp settings.

9.3. Charts of series

The chart of series is a chart added for an instrument. Please note, that you cannot add charts for the negotiated instruments (see section 9.4).



This chapter covers the following topics:

- chart creating guide;
- chart properties.

9.3.1. Creating a chart

You can create graphical chart for a particular instrument in the following ways:

- via the **Tech. analysis/ Open chart** main menu item – see procedure 9.1;
- by pressing the  button on the main window instrument panel – see procedure 9.4;

- from the **All trades/ requests, Your trades/ requests, Your orders/ requests, Financial instruments, Options board, Order-book** windows, from the **Favorite instruments** section of the side panel via the **Open chart** context menu item (see procedure 9.2);
- from the **All trades/ requests, Your trades/ requests, Your orders/ requests, Financial instruments, Options board** windows, from the **Favorite instruments** section of the side panel by dragging (see procedure 9.3);
- by pressing the  button on the **Tech. analysis** window instrument panel – see procedure 9.5;
- by pressing the **Add** button in the **Series** tab in the **Object manager** window (the  button of the **Tech. analysis** window instrument panel - see **section 9.7**.

If the **Tech. analysis** already contains at least one graphical chart, the newly added one will have the time frame and display period of the previously added chart.

Procedure 9.1. Creating a chart in a new window via the main menu

1. Open the **Tech. analysis/ Open chart** main menu item.
2. Select the instrument you need by one of the following methods:
 - from the favorite instruments list;
 - from the **Favorite instruments** window (see section 5.11.2);
 - from the **Select instrument** window (see section 5.11.1).
3. Press **OK** or double-click the instrument name with the left mouse button.
4. The new **Tech. analysis** window will appear on the screen, containing chart for the selected instrument.

Procedure 9.2. Creating a chart from the All trades/ requests, Financial instruments, Order-book windows via the context menu

1. In the **All trades/ requests, Financial instruments, Order-book** windows, select the instrument you need by placing the mouse cursor on it.
2. Click the right mouse button to open the context menu.
3. Open the **Open chart** menu element.
4. The new **Tech. analysis** window will appear on the screen, containing chart for the selected instrument.

Procedure 9.3. Dragging a chart into the already opened window

1. In the **All trades/ requests, Financial instruments, Order-book** windows or in the **Favorite instruments** section of the side panel, select the instrument you need by placing the mouse cursor on it.
2. Press the left mouse button (the  icon will appear near the mouse cursor) and drag the instrument into the **Tech. analysis** window .
3. Release the mouse button:
 - in an area of the **Tech. analysis** window – the chart will be added into the selected area;
 - on the horizontal axis - the chart will be added into a new area of the **Tech. analysis** window.

Procedure 9.4. Creating a chart in the new Tech. analysis window

1. Press the  button on the main window instrument panel.

2. Select the instrument you need by one of the following methods:
 - from the favorite instruments list;
 - from the **Favorite instruments** window (see section 5.11.2);
 - from the **Select instrument** window (see section 5.11.1).
3. The new **Tech. analysis** window will appear on the screen, containing chart for the selected instrument.

Procedure 9.5. Creating chart in a new area of the opened Tech. analysis window

1. Press the  button on the **Tech. analysis** window instrument panel.
2. Select the instrument you need by one of the following methods:
 - from the favorite instruments list - by pressing the small button with black arrow;
 - from the **Select instrument** window (see section 5.11.1) - by pressing the button itself.
3. The new **Tech. analysis** window will appear on the screen, containing chart for the selected instrument.

9.3.2. Charts properties

You can open the chart properties window by one of the following methods:

- via the **Properties** context menu item, opened from a selected chart or a chart ticker;
- in the **Object manager** mode (**Ctrl+J**, or the  button of the **Tech. analysis** window panel instrument), by pressing the **Properties** button, with the mouse cursor placed on the chart you need in the **Series** tab.

The chart properties are displayed in a separate window - fig. 9.8.

Some of the properties are fully equal to that specified in the **Settings/ Terminal settings** main menu item of the **Chart and TA** section– see section 9.9.4.

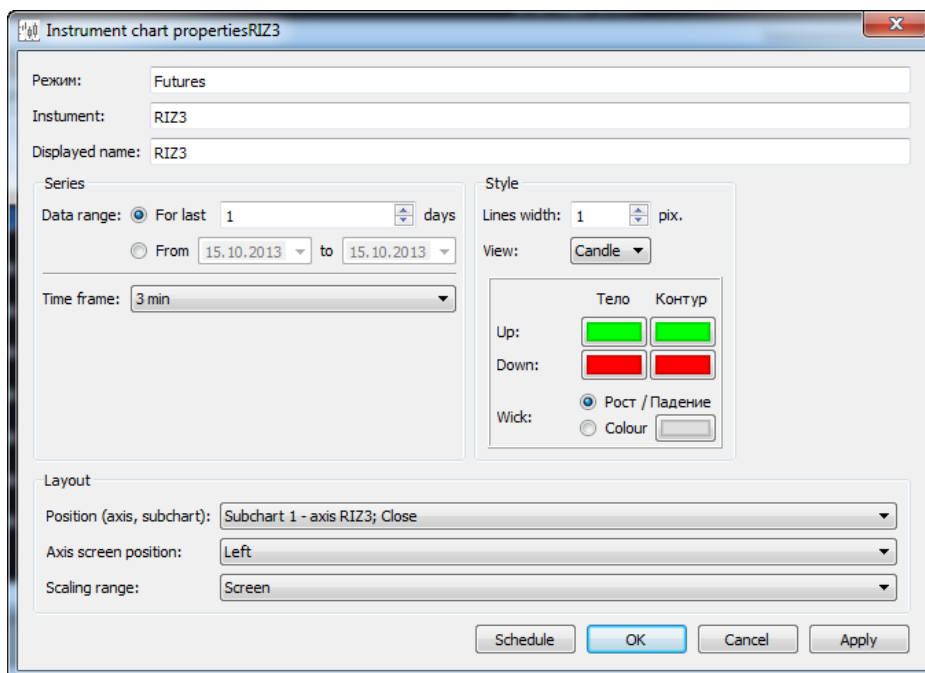

Fig. 9.8. Chart properties

The main chart properties are shown in tab. 9.10

The **Board** field displays the trading board for the chart.

The **Instrument** field displays the instrument code for the chart.

The **Displayed name** displays the chart name equal to that in the **Tech. analysis** window.

By default, the chart has the ticker equal to that of the instrument code. The ticker can be later changed by user, that is why the value in the **Displayed name** field may differ from the instrument code value.

You can specify chart display time by two methods:

- by setting number of days starting from the current day - the chart will be created according to data of the last two days. I. e., if the value is '2', the chart will be created according to the data of the current day and the day before;
- by setting a period of time – with two dates. The chart will be created according to the data of dates within the specified period, including the two specified dates.

You can switch between two methods by clicking the small white circle with the left mouse button.

The **Schedule** button displays the session schedule table – see fig. 9.8 (for detailed information see section 9.9.1). In this window, you cannot edit the schedule table.

You can specify the chart position in the **Tech. analysis** window by using the **Position (axis, subchart)** field. You can move the chart from one area to another or add it into a new separate area. The **Position (axis, subchart)** field value can be selected in the appropriate drop-down list. Thus, you can select from:

- all active areas with charts. For each area, there are several options available to pin the chart to: a separate axis or the axis of an already added chart;
- a new area, if the selected chart is not a single one in this area. The chart then will be moved to the separate new area.

The **Scaling range** field in the **Chart properties** window displays the maximum and the minimum values of the chart along the vertical axis in the current moment of time.

9.4. Indicators

The indicator charts are the additional charts which can be added to the series charts. The number of indicator charts displayed simultaneously is not limited.

There are two types of indicators: the standard indicators which are included into the application, and indicators created by users. Unlike the user indicators, the standard indicators are updated automatically at installing a new version of the terminal application. You cannot change or remove the standard indicators.

The following indicators are available in the terminal application:

- **ADX** – average directional movement index;
- **ADXR** – average directional movement index rating;
- **Ask** – lowest priced sell order from **Financial instruments**;
- **Ask_Bid** – best buy and sell price from **Financial instruments**;
- **AverageTrueRange** - average true range;
- **AvgPrice** - average price;
- **Bid** – highest priced buy order from **Financial instruments**;
- **BollingerBands** – Bollinger Bands;
- **Close** – closing price;

- **ClosePrice** – last trade price in session (close);
- **Const** –horizontal line;
- **MarketPrice** - current quotation;
- **Custom1Line** - custom line;
- **EMA** – exponential moving average;
- **High** – highest price;
- **Ichimoku** – Ichimoku;
- **SettlementPrice** - last clearing quotation;
- **LastPrice** - last trade price from tab **Financial instruments**;
- **Low** – lowest price;
- **MACD** – moving average convergence-divergence;
- **OI** – open interest;
- **SettlementPriceOpen** - previous quotation;
- **Open** – open price;
- **OpenPrice** – first trade price in session (open price);
- **PriceLimits** – price limits from tab **Financial instruments**;
- **PriceMinMax** – lowest and highest price from tab **Financial instruments**;
- **RSI** – relative strength index;
- **SMA** – simple moving average;
- **TheorPrice** - option theoretical price;
- **TrueRange** - true range (difference between the values of two variables for the current bar);
- **Value** - candlestick volume (money). For this indicator, the default accuracy is 0 digits after decimal point;
- **Volume** - candlestick volume (lots/ units). For this indicator, the default accuracy is 0 digits after decimal point;
- **WMA** – weighted moving average;

Indicator charts can be added either into separate areas or into a single area containing the main series chart.



Fig. 9.9. Example of indicator chart created in the same area with the main series chart



Fig. 9.10. Example of indicator chart created in the separate area

To view the part of the chart located to the right of the current moment along the axis, you can specify the tight offset in the **Tech. analysis** window by using the **Window settings/ Offsets** context menu item.

Crossed indicator chart ticker indicates errors in indicator code (for the user indicators only!). You can view the error details via the **Show errors** context menu item, opened from the indicator chart or its ticker, or by double-clicking the indicator ticker in the **Tech. analysis** window area.

9.4.1. Creating indicator charts



To create an indicator chart, you should first create the series chart. Indicator charts always derive from the main one, that is why you cannot create indicator charts separately.

By default, the indicator chart can be created either in a new separate area of the **Tech. analysis** window or in the same area with the series chart. These parameters can be specified in the **Scaling** section, along with the indicator appearance settings (the **View** tab of **Indicator editor**) – see section 9.8.1.

You may move the indicator chart to any area in the window (see section 9.5.5) and pin it to any axis (see section 9.5.4).

All the operations applicable to the instrument charts are also applicable to the indicator charts. Changing a main chart parameters (for example, time frame value) will affect the indicator chart appearance as well.

You can create an indicator chart by the following methods:

- from the **Tech. analysis** window, by pressing the  button on the instrument panel;
- by pressing the **Add** button in the **Indicators** tab of the **Object manager** window (the  button on the instrument panel of the **Tech. analysis** window - see section 9.7);
- via the **Add indicator** context menu item, opened by pressing the right mouse button on the selected series chart.

All the operations applicable to the instrument charts are also applicable to the indicator charts, i. e. you can select them, move, delete or pin to another axis. Please note that you cannot change the time frame and chart creation time interval values; they are inherited from the series chart.

Procedure 9.6. Creating of indicator chart using toolbar in the **Tech. analysis** window

1. Press the  button on the instrument panel of the **Tech. analysis** window.
2. In the **Indicator selection** window (see section 9.4.2), select the instrument you need in the **Series** field.
3. In the indicator list, select the indicator you need by placing cursor on it.

4. Press **OK**.
5. The indicator chart will be added into the **Scaling** section (see section 9.4.3) in accordance with the specified parameters.

Indicator editor (see section 9.8) is used for creating indicator charts different from the ones in the standard list. Using the editor, you can edit the existing indicator codes or add new ones.

All edited indicators along with newly created ones are listed in the general indicators list, so that you can work with them as you do with any other standard indicator – see section 9.4.1. If you make a change to indicator code for an indicator chart, that has been already created and added into the **Tech. analysis** window, its ticker will be marked with '*' symbol (for example, **MACD:RIZ,1 min***), which means that the current indicator code differs from the one the chart has been created with. To create an indicator chart with the new code, close the previously added chart and create it anew.

9.4.2. Indicator selecting window

The **Indicator selection** window is used for selecting indicator selection mode (see section 9.4.1).

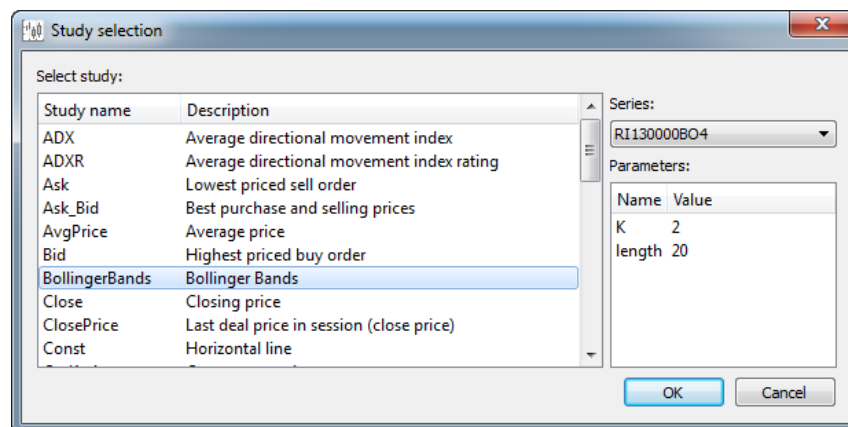

Fig. 9.11. Indicator selecting window

In the drop-down list of the **Series** field select a series to create chart. The drop-down list contains only the series for charts already added into the **Tech. analysis** window, including hidden charts. Every record in the list corresponds to the particular chart ticker. In case there are more than one chart for the same instrument in the window, the list will contain all of them, so that you will be able to select any such record for creating the indicator.

The **Parameters** section contains parameters of the selected indicator (the one under the mouse cursor). To edit a parameter value, double-click a record with the left mouse button. The record then will be switched into the edit mode and coloured in blue.

To create an indicator, click its name in the list and press **OK** (see fig. 9.11).

The **Tech. analysis/ Indicator editor** main menu item is used for editing the indicator location (in case you need to edit the default value). In order to do this, open an indicator in the edit mode (the **Open** button – see fig. 9.11) and enter a new value in the **Scaling** section of the **View** tab:

- **Separate axis** - the indicator chart will be added into a separate area of the current **Tech. analysis** window;
- **Series axis** – the indicator chart will be added into the area containing the series chart and pinned to the series axis.

After adding new indicators into the appropriate folder (simply by copying), you should reopen the **Indicator selection** window to make the new indicators visible in the list (see fig. 9.11).

9.4.3. Indicator chart properties

You can open the indicator chart properties window by the following methods:

- via the **Properties** context menu item, opened from the previously selected ticker or ticker chart;

- in the **Object manager** mode (**Ctrl+J** or the  button of the **Tech. analysis** window instrument panel), by pressing the **Properties** button. Note, that a chart should be previously selected in the **Indicators** tab.

The chart properties are displayed in a separate window - see fig. 9.12.

Some of the properties are totally equal to that of the indicator chart properties (**Settings/ Terminal settings/ Charts and TA** tab **Indicators** – see section 9.9.5).

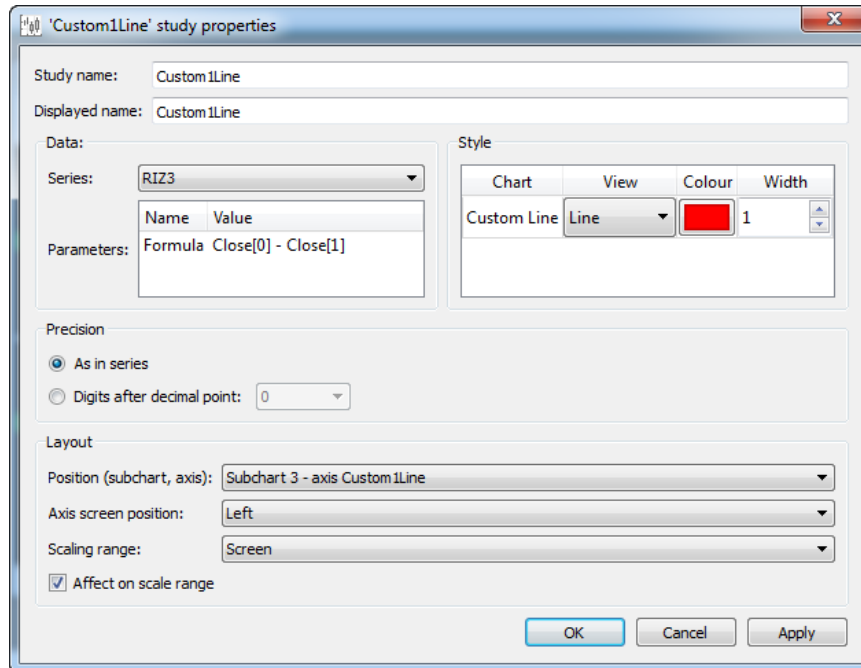

Fig. 9.12. Indicator chart properties

The main chart parameters are described in tab. 9.11.

The **Indicator name** field contains indicator name as it displayed in the **Indicator selection** window (fig. 9.11).

The **Displayed name** field contains chart name as it displayed in the **Tech. analysis** window. The indicator chart name is editable, that is why it may not correspond to the indicator name.

You can specify the number of digits after decimal point for the vertical axis value in the **Precision** section by selecting one of the following options:

- **As in series** – the number of digits after decimal point as that of the series chart;
- **Digits after decimal point** – the number of digits after decimal point can be set manually or selected from the drop-down list.

The indicator properties window allows to specify the chart location in the **Tech. analysis** window via the **Position (subchart, axis)** field. Using this option, you can move chart from one area into another or add the chart into a new separate area. The **Position** field value can be selected in the drop-down list among the following objects:

- all active areas with charts. For each area, there are two options available: a separate axis or axis of a chart in this area. Therefore, you can pin the chart in the area to a separate axis or to an axis of chart already added into the area;
- a new area, if the selected chart if the selected chart is not alone in the area. The chart then will be moved into a separate area;
- series axis. The selected chart will be pinned to the axis of the chart of its series and moved into the appropriate area. The menu item is unavailable for indicators which are created based on more than one series.

The **Scaling range** field in the **Chart properties** window displays the maximum and the minimum values of the chart along the vertical axis in the current moment of time.

The **Affect scale range** option allows to define whether the indicator chart values will affect the automatic scaling or not. The option is useful only for the indicator charts pinned to a single axis with an other chart. When the option is disabled, the current indicator values will not affect the automatic scaling, therefore, the scaling will be performed based on the other charts values of the same axis (this may lead to situation when a part of the indicator chart will be hidden from the window). By default, the option status is specified within the indicator code - see section 9.8.1.

For the indicator charts, the **Properties** window also contains the series charts tickers in the **Series** section, for which the indicators have been calculated.

The **Style** table (right) of the **Indicator properties** window (fig. 9.12) contains the chart tickers for the indicator; there can be more than one of them for a single indicator. You can specify view and colour of every indicator. To specify view, double-click a cell in the **View** column with the left mouse button, press the button with small arrow and select the option you need in the drop-down list: line, histogram or dots. To change the chart colour, press an appropriate colour cell.

List of parameters of indicators can be found in the **Data** section of the **Parameters** table (fig. 9.12); to check a parameter value, double-click a field with parameter value with the left mouse button. This method allows to change some parameters of an already created indicator editing its code. After some changes have been made, the indicator chart will be redrawn according to the new values.

9.5. Actions with charts

This section contains information about main actions with charts and answers the following questions:

- how to change a chart instrument;
- how to add more than one chart into the same window area;
- how to move chart into a new area of the current window;
- how to pin several charts to the same vertical axis;
- how to move a chart;
- how to hide a chart;
- how to change a chart name;
- how to remove a chart;
- how to change scale of a chart.

9.5.1. How to change a chart instrument

Sometimes it may be necessary to change the instrument code of a chart, without removing indicators. To do this, use the **Select another instrument** context menu item, opened from the series chart. The instrument list will appear on the screen, where you can select an instrument you need by double-clicking it with the left mouse button or pressing the **OK** button.

The chart in the current **Tech. analysis** window will be redrawn according to the newly selected instrument. All the indicator charts will be also redrawn, accordingly.

9.5.2. How to add more than one chart into the same window area

A single window area can contain as many charts as it is needed. Below are the methods for adding more than one chart into the same area:

- To move chart from one area into another, select a chart and drag it into another area of the **Tech. analysis** window with the left mouse button (the mouse cursor will change to ). To drop the chart release the left mouse button.

Please note, that using this method you can move charts between areas within the same window. You cannot move charts between windows.

- Also, you can move chart from one area into another by changing its properties in the **Properties** window via the **Object manager** context menu item (see section 9.7) by changing value in the **Position** field.
- You can add a new chart into the existing **Tech. analysis** window. To do this, select an instrument either in the **All trades/ requests, Financial instruments, Order-book** window or in the **Favorite instruments** section of the side panel. Select the instrument you need by clicking it with the left mouse button and drag into an area of the **Tech.**

analysis window (the mouse cursor will change to ). To drop the chart release the left mouse button.

9.5.3. How to move chart into a new area of the current window

You can move a chart into a new area of the current **Tech. analysis** window by the following methods:

- via the **Properties** window, opened from the context menu or via **Object manager** (see section 9.7), by changing the **Position** field value. A new value can be selected in the **New subchart** drop-down list;
- by selecting a chart and drag it to the time axis using the left mouse button.

9.5.4. How to pin several charts to the same vertical axis

A single area can contain no more than 3 vertical axis at once. Adding more vertical axis will remove some of the existing ones.

By default, every new chart is added or moved along with its own vertical axis. But it may be reasonable to put some charts with equal scales to the same vertical axis.

Also, sometimes it may be convenient to put a series chart and its indicators to the same vertical axis.



Fig. 9.13. Charts with different vertical axis



Fig. 9.14. Charts with the same vertical axis

Procedure 9.7. How to pin several charts to the same vertical axis

1. In the **Tech. analysis** window, open the **Properties** window by with one of the following methods:
 - via the **Properties** context menu item, opened on the selected chart;
 - via **Object manager** (the  button of the instrument panel), by pressing the **Properties** button.
2. Change the **Position** window value (the axis) by selecting it in the appropriate drop-down list.
3. Press **Apply** or **OK**.
4. The chart will be pinned to the selected vertical axis.

Procedure 9.8. How to unpin a chart from a vertical axis

1. In the **Tech. analysis** window, open the **Properties** window by with one of the following methods:
 - via the **Properties** context menu item, opened on the selected chart;
 - via **Object manager** (the  button of the instrument panel), by pressing the **Properties** button.
2. Change the **Position** window value (the axis) by selecting it in the appropriate drop-down list. Please note, that you should select a separate axis in the area you want to move your chart to;
3. Press **Apply** or **OK**.
4. The chart will be unpinned from the shared vertical axis and pinned to the selected axis in the selected area

By moving a chart pinned to a vertical axis with other charts, the chart will be unpinned from the shared axis and pinned to its own separate one in the selected area.

9.5.5. Moving charts between areas of the current window

It is unable to move charts from one **Tech. analysis** window to another. All you can do is to move charts from one area into another within the same **Tech. analysis** window.

You can move charts from one area into another by the following methods:

- select a chart and drag it using the left mouse button;
- in the **Properties** window of the chart (see section 9.3.2), changing value in the **Position** field by selecting the area name in the appropriate drop-down list. To select a new separate area select the **New subchart** value. Please mind the axis name in each area in order not to pin your chart to any other axis.

9.5.6. How to find a 'lost' chart

Sometimes you may 'loose' a chart which had has been moved out of the window borders. To 'find' the chart, you should

select the chart ticker and use the  button on the instrument panel of the **Tech. analysis** window to select any of the automatic scaling options; the automatic scaling options are also available in the context menu opened on the selected chart. After the automatic scaling option is applied, the chart will be displayed in the **Tech. analysis** window.

9.5.7. How to hide a chart

You can hide a chart using **Object manager** (the  button on the instrument panel of the **Tech. analysis** window), by changing value in the **Visibility** with the left mouse button.

Hidden charts are not displayed in the **Tech. analysis** window but still remain active. This means that you are still able to view all series chart indicators without viewing the chart itself.

Also, you can hide a chart using the **Hide** context menu item (the context menu must be opened from this chart or from the chart ticker).

To make the chart visible again, you should change the change value in the **Visibility** field.

When there are no visible objects left in the **Tech. analysis** window, the **Object manager** manager button (see fig. 9.15) appears in the main window area. Press this button to make objects visible via **Object manager**.

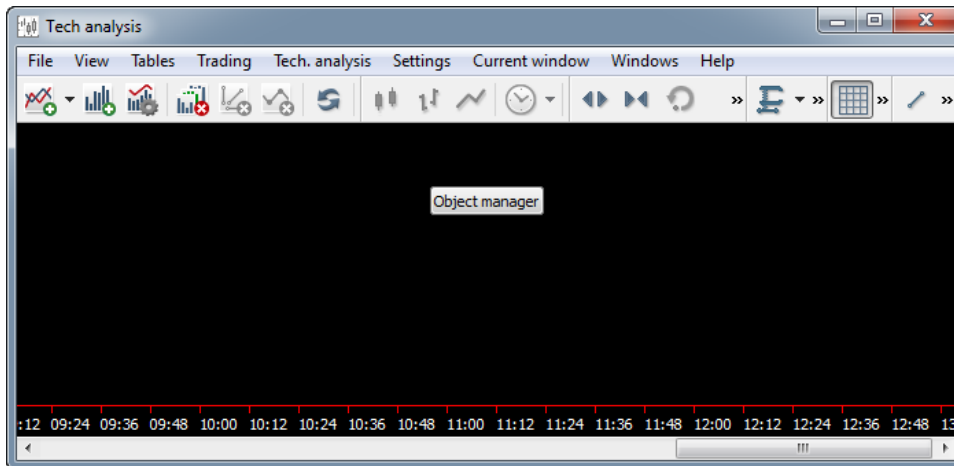

Fig. 9.15. The Tech. analysis window (all objects are hidden)

9.5.8. How to change a chart name



Every chart has its own name aka ticker, which consist of two parts. You can edit the first part of the ticker, which consists of the instrument code or indicator name. The second part contains some additional information about chart, and is not editable.

You can change a chart name by one of the following methods:

- by double-clicking a chart ticker in the upper-left corner of the **Tech. analysis** window. When the cursor starts to blink, enter the chart new name into the appropriate field. Press **Enter** to finish;
- by opening the **Properties** window of a chart or an indicator and edit text in the **Displayed name** window. To save the changes you have made, press **OK** or **Apply**.

9.5.9. How to remove a chart

You can remove a chart in the **Tech. analysis** window by one of the following methods:

- via the **Remove** context menu item, opened from the selected chart;
- by pressing the **Delete** key on the keyboard (you should select a chart before);
- via **Object manager** (the  button of the instrument panel), by pressing the **Remove** button;
- by pressing the  button of the instrument panel (you should select a chart before);

- by deleting all indicator charts via the  button of the instrument panel.







Deletion an instrument chart causes deletion of all its indicator charts. Before deletion is complete, the confirmation dialog will appear on the screen.

You cannot remove the last series chart left in the **Tech. analysis** window; when there is the last chart left in the window, the **Remove** button becomes inactive.

Deletion of an area in the **Tech. analysis** window (the **Delete** context menu item opened from the area) causes deletion of all the charts it contains.

9.5.10. How to change scale of a chart

You can change scale of a chart by the following methods:

- by changing the horizontal axis scale using the  and  buttons of the instrument panel. The horizontal (time) axis is the same for all charts in the **Tech. analysis** window, so that changing its scale will affect all the charts in the window;
- by changing the vertical axis scale using the  and  buttons of the instrument panel. The changes will be applied to the axis of the selected chart. If no charts has been selected, the changes will be applied to any series chart in the **Tech. analysis** window;
- by zooming in the selected part of the chart: press the  button on the instrument panel and select a chart area using mouse (click the left mouse button and stretch the square to the area you want to select);
- by changing scale smoothly with mouse: click the left mouse button on the axis and move cursor from left to the right, and vice versa, zooming the chart in and out along the selected axis;
- by undoing the changes you made. Pressing the  button will return you back to the default scale settings;
- by selecting the standard scaling settings: for the screen (**Ctrl+F**) or for the whole series (**Ctrl+D**). The  button allows to select scaling type.

9.5.11. How to move a chart along the time axis

You can move a chart along the time axis by the following methods:

- using horizontal slide-bar;
- using the 'Right' and 'Left' arrow buttons on the keyboard;
- using the mouse wheel (if there is one);
- pressing the **End** button - to jump to the chart end.

9.6. Additional elements - graphical objects





The support and resistance lines are widely used in technical analysis.

Resistance levels connect critical market peaks. They appear when price ceases rising and starts to fall. When the resistance level is broken through, it becomes support level.

Support levels connect critical market bottoms. They appear when price ceases falling and starts to rise. When support level is broken through, it becomes resistance level.

Support and resistance levels can be displayed as trend lines, horizontal lines and Fibonacci lines.

The **Tech. analysis** window allows to add support and resistance levels lines via the following buttons:

-  - trend line with arbitrary angle – support/resistance level;
-  - horizontal line – support/resistance level;
-  - Fibonacci lines;
-  - Fibonacci arcs;
-  - Fibonacci fan.

The additional elements are pinned to vertical axis of any chart within the current area. Therefore, your actions with a chart such as deleting, removing, etc.) will not affect the support/resistance lines (for details see section 9.6.8 and section 9.6.9). In case of moving a chart, the trend line (resistance line) will also move up and down along the axis following the chart.

In order to know the axis a trend line is pinned to, you should view the **Axis** field value of the line parameters – see section 9.6.6. To change the axis for the trend line, enter a new value in the **Axis** field.

The additional graphical objects are displayed in the **Tech. analysis** window within the specified time interval. I. e., if the time period is set as '2 days', you will be able to see trend lines added yesterday. Unlike the previous case, if the time period is set as '1 day', the **Tech. analysis** window will not display the trend line added yesterday.

9.6.1. Trend line

Trend line is a tool, which indicates the current market trend (price direction). Trend line tends to catch a moment when price break through trend line moving down with up trend and moving up with up trend.

Trend line – is a straight line which connects two maximum or minimum price points of a chart.



To add a trend line, press the  button on the instrument panel of the **Tech. analysis** window – see procedure 9.9;



Fig. 9.16. Trend line

Procedure 9.9. How to add a trend line

1. In the **Tech. analysis** window, press the  button on the instrument panel;
2. Click the initial point of the trend line with the left mouse button. After that, release the mouse button;
3. Place the mouse cursor to the end point of the trend line and click the left mouse button;
4. The trend line will be added into the window, connecting the two points. You can edit the trend line inclination and location in the current area by dragging its initial and end points using your mouse.

9.6.2. Resistance and support levels

Resistance and support levels are located parallel to the time axis.



To add a resistance/support level in the window, press the  button on the instrument panel of the **Tech. analysis** window – see procedure 9.10.



Fig. 9.17. Resistance and support levels

The value on the line indicates the level position on the vertical axis.

Procedure 9.10. How to add a resistance /support level

1. In the **Tech. analysis** window, press the  button on the instrument panel;
2. Click a point on the vertical axis with the left mouse button. After that, release the mouse button;
3. The trend line will be added into the window as an infinite straight horizontal line starting from the selected point. You can move the trend line up and down along the vertical line by clicking and dropping its blue points using your mouse.

9.6.3. Fibonacci lines

Fibonacci lines are used for analyzing and forecasting marketing trends for different financial instruments. Using Fibonacci lines, traders are able to define correction course along with strong resistance and support levels.

When drawing Fibonacci levels, a trend line connecting two extreme points is added first. After that, the 38,2%, 50% and 61,8% Fibonacci levels starting points are added onto the trend line. Then, horizontal lines (Fibonacci levels themselves) are added starting from these three points.



To add Fibonacci levels, use the  button of the instrument panel in the **Tech. analysis** window – see procedure 9.11.



Fig. 9.18. Fibonacci lines

Procedure 9.11. How to add Fibonacci lines

1. In the **Tech. analysis** window, press the  button of the instrument panel.
2. Click the initial point with the left mouse button (dash line - see fig. 9.18). Release the mouse button.
3. Click the end point with the left mouse button. Release the mouse button.
4. The trend line will be added into the window as dash line with marked initial and end points. You can change angle of the trend line by dragging and dropping its initial and end points using your mouse. Fibonacci levels will be added automatically in accordance with the specified values.

Every Fibonacci line displays absolute value along the vertical axis and percentage according to the initial point.

9.6.4. Fibonacci arcs

Fibonacci arcs are used to forecast possible price resistance and support levels locations. To improve the forecast results, **Fibonacci fan** (see .9.5.5) is also added into the window. In this case, support level is defined as the cross-point of these two objects.

When drawing Fibonacci levels, a trend line connecting two extreme points is added first. After that, the 38,2%, 50% and 61,8% Fibonacci levels starting points are added onto the trend line. Then, arcs are added into the window, with center in the second point.

To add Fibonacci arcs, use the  button of the instrument panel in the **Tech. analysis** window – see procedure 9.12.

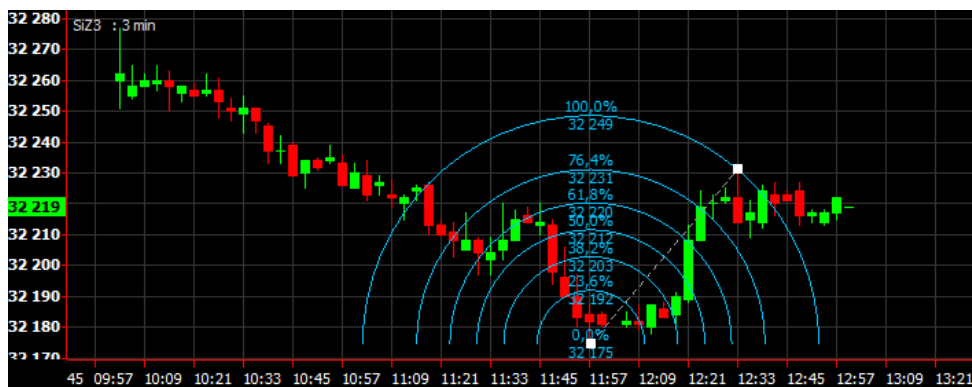



Fig. 9.19. Fibonacci arcs

Procedure 9.12. How to add Fibonacci arcs

1. In the **Tech. analysis** window, press the  button of the instrument panel.
2. Click a point in the window, where you want center of the arcs to be added, then, holding the left mouse button pressed, drag the mouse cursor to another extreme point, where the arc with the biggest radius will be added (dash line - fig. 9.19).
3. Click the left mouse button on the end point.
4. The trend line will be added into the window as dash line with marked initial and end points. You can change angle of the trend line by dragging and dropping its initial and end points using your mouse. Fibonacci arcs will be added automatically in accordance with the specified values.

Every Fibonacci line displays absolute value along the vertical axis and percentage according to the initial point.

9.6.5. Fibonacci fan

Fibonacci fan is a sort resistance/support levels. To get more precise forecast results, it is recommended to use other Fibonacci tools as levels and arcs along with Fibonacci fan.

When drawing Fibonacci fan, a trend line connecting two extreme points is added first. Then, an 'invisible' vertical line crossing the second point is added. After that, three trend lines are added, crossing the 'invisible' vertical line at the 38,2%, 50% and 61,8% Fibonacci levels.



To add Fibonacci fan, press the  button of the instrument panel in the **Tech. analysis** window – see procedure 9.13.



Fig. 9.20. Fibonacci fan

Procedure 9.13. How to add Fibonacci fan

1. In the **Tech. analysis** window, press the  button of the instrument panel.
2. Click a point you want to start the line connecting extreme points (dash line - see fig. 9.20) with the left mouse button. Release the mouse button.
3. Place mouse cursor to where you want to draw the trend line and click the left mouse button.
4. The trend line will be added into the window as dash line with marked initial and end points. You can change angle of the trend line by dragging and dropping its initial and end points using your mouse. Fibonacci levels will be added automatically in accordance with the specified values.

Every Fibonacci line displays absolute value along the vertical axis and percentage according to the initial point.

9.6.6. Trend line properties

Trend line properties are displayed in a separate window. To open the window, use the **Properties** context menu item opened on a trend line.

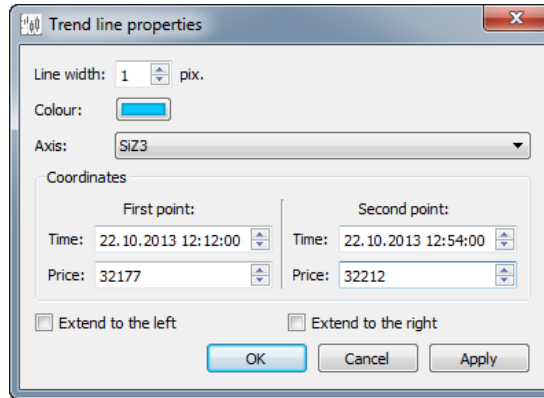

Fig. 9.21. Trend line and Fibonacci lines properties

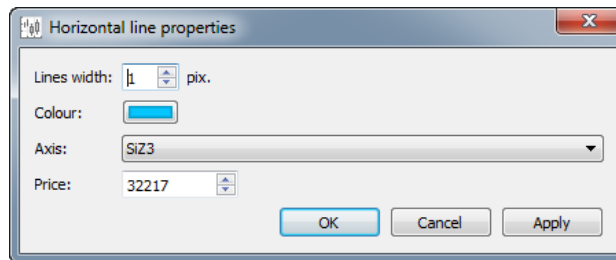

Fig. 9.22. Horizontal line properties

Tab. 9.2. Trend line properties

Parameter	Details
Line width	Line width in pixels. To change it, type a new value using your keyboard or use the small arrows.
Colour	Line colour. To change it, press a colour field (button). To select a new colour, use the standard Select colors window.
Axis	Axis name, to which line is pinned. To change the axis, select a new one in the drop-down list, containing the complete list of all axis you can pin the line to.
Coordinates (the left and the right points, separately)	
Time	Time axis coordinates.
Price	Vertical axis coordinates.
Options and buttons	
Extend to the left	The option allows to extend line infinitely to the left. To enable/disable the option click the left mouse button.
Extend to the right	The option allows to extend line infinitely to the right. To enable/disable the option click the left mouse button.
OK	Confirms the changes you made and closes the properties window.
Cancel	Cancels the changes you made and closes the properties window.
Apply	Applies the changes you made and closes the properties window.

9.6.7. Moving trend lines

To edit trend line direction and location in the current area of the **Tech. analysis** window, you should do the following:

1. Select a trend line as object by clicking it with the left mouse button.
2. Move direction points (blue dots) by dragging them using your mouse.
3. Move the entire line, clicking its body and dragging it to another location.



9.6.8. Moving charts including its trend lines

When moving a chart, for which trend lines have been added, the following moving options are available:

1. You can move the chart including its trend lines if the trend lines are pinned to the chart axis, and there are no more charts in the current window area pinned to the same axis.
2. You can move a chart into a new area, leaving its trend lines in the current area if
 - trend lines are pinned to another charts axes;
 - there are some charts in the current area pinned to the same axis.

9.6.9. Removing graphical objects

You can remove graphical object by the following methods:

- via the **Remove** context menu item, opened from a graphical object;
- by selecting an object and pressing the **Delete** key on your keyboard;
- by clicking the **Remove** button in the **Object manager** mode (the  button of the instrument panel) in the **Drawings** tab;
- by selecting an object and clicking the  button of the instrument panel;
- by removing all graphical objects from all areas of the current **Tech. analysis** window via the  button of the instrument panel.

Before removing an object, you will receive the confirmation dialog: *'Are you sure you want to remove the trend line?'*. Press **Yes** to confirm or **No** to cancel.

If a trend line is pinned to an axis of the chart to be removed last, this trend line will be also removed. Generally: trend lines are removed along with the last chart on the axis.

The graphical objects are pinned to the vertical line, so that they may remain in the window – see section 9.6.8).

9.6.10. Graphical objects visibility

All graphical objects in the **Tech. analysis** window may be either visible or hidden. To manage this option, you should

use the **Object manager** mode (the  button of the instrument panel in the **Tech. analysis** window), by changing the **Visibility** field value in the **Drawings** tab. To change the value, use the left mouse button.

A hidden object in the **Tech. analysis** window still remains active.

Also, you can hide an object via the **Hide** context menu object, opened on the object or on its ticker.

You can make a hidden object visible only via **Object manager**, by changing the value in the **Visibility** field.

9.7. Object manager

The **Object manager** window allows to view and setup all objects of the **Tech. analysis** window. You can open the **Object manager** window from the **Tech. analysis** window by the following methods:

- by clicking the  button of the instrument panel;
- by pressing the **Ctrl+J** key combination;
- via the **Object manager** context menu item, opened in any point of the charts window.

The window allows to work with the graphical objects (series charts, indicators, trend lines) preferences without selecting the objects.

The **Object manager** allows to hide objects in the **Tech. analysis** window, leaving them active. It may be useful when you do not need a chart in the window, but cannot delete it as you have some other charts based on it. To show/hide an object in the window, click the **Visibility** (see fig. 9.23) column with the left mouse button. You can hide any of graphical object using the appropriate tab of the **Object manager**.

You can hide some previously hidden objects enabling the **Visibility** option for the hidden objects.

There are three tabs in the **Object manager** window:

- **Series** (see fig. 9.23) – all series charts in the current **Tech. analysis** window;
- **Indicators** (see fig. 9.24) – all indicator charts in the current **Tech. analysis** window;
- **Drawings** (see fig. 9.25) – all graphical objects in the current **Tech. analysis** window.

Tab. 9.3. Function buttons in the Object manager window

Button	Details
Properties	Opens the Instrument chart properties , Indicator properties or Trend line properties window, depending on the tab. For chart properties details, see section 9.3.
Remove	Deletes the selected object. Before deleting, you will receive a confirmation dialog: 'Are you sure you want to delete chart? All indicators based on this series will be also deleted'. Select Yes to delete the series chart including all its indicator charts. You cannot delete the last series chart in the window. The button will be disabled. Before deleting an indicator chart, you will receive a confirmation dialog: 'Are you sure you want to delete indicator?' Select Yes to delete the indicator chart. Before deleting a graphical object, you will receive a confirmation dialog: 'Are you sure you want to delete the trend line?'. Select Yes to delete the graphical object.
Add	Opens the Select instrument window(see section 5.11.1) in the Series tab. After selecting an instrument, a new area will be added into the window, containing the chart for the selected instrument. Also, a new record with the new object will be added into the Object manager window into the Series tab. Opens the Indicator selection window (see section 9.4.2) in the Indicators tab. After selecting an instrument, a new indicator chart will be added into the window. Also, a new record with the new object will be added into the Object manager window into the Indicators tab.
Close	Closes the Object manager window.

The **Object manager** allows to do the following actions:

- hide a graphical object using the **Visibility** option;
- view and change an object properties clicking the **Properties** button: for example, the object location and the axis it is pinned to. Also, you can open the **Properties** window by double-clicking a record in the **Object manager** window with the left mouse button;
- delete an object from the **Tech. analysis** window using the **Remove** button;
- add a new object into the **Tech. analysis** window using the **Add** button.

9.7.1. The Series tab

The **Series** tab of the **Object manager** window contains all instrument charts names for the charts added into the current **Tech. analysis** window.

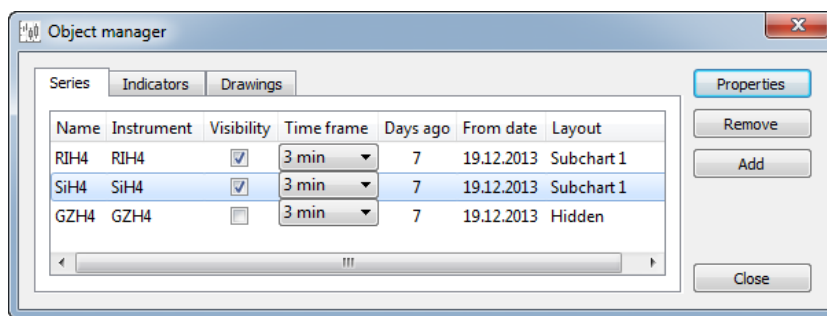

Fig. 9.23. Object manager. Series.

Tab. 9.4. Parameters in the Series tab (Object manager)

Parameter	Details
Name	Chart name in the charts window - chart ticker in the Tech. analysis window. By default, consists of the code of the series, to which the chart belongs. You can change the chart name - see section 9.5.8.
Instrument	Code of the series, to which the chart belongs.
Visibility	Chart visibility option in the Tech. analysis window. When option is enabled, the chart is visible, and vice versa.
Time frame	Data aggregation time period. This parameter can be changed by double-clicking the Time frame field with the left mouse button.
Days ago	How many days ago the chart has been added. 1 – today's data, 2 – yesterday's and today's, etc.
From date	The date to count back from.
Location	The Tech. analysis window area, where the chart is located. The areas are arranged by sequence top to bottom. If a chart is hidden, its area is not listed.

9.7.2. Indicators tab

The **Indicators** tab of the **Object manager** window contains all indicators for all charts added into the **Tech. analysis** window.

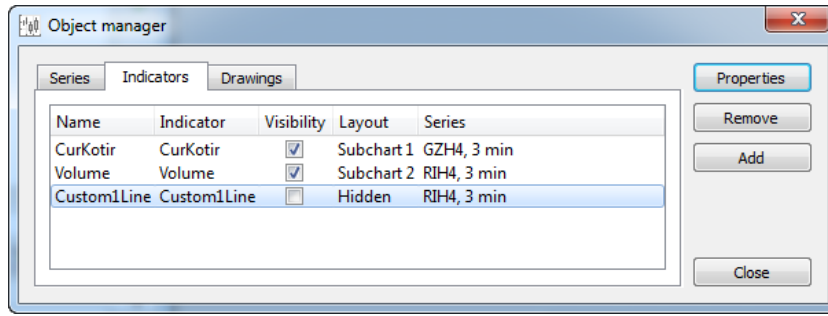

Fig. 9.24. Object manager. Indicators.

Tab. 9.5. Parameters in the Indicators tab (Object manager)

Parameter	Details
Name	Chart name in the charts window - chart ticker in the Tech. analysis window.
Indicator	Indicator name, to which the chart belongs.
Visibility	Chart visibility option in the Tech. analysis window. When option is enabled, the chart is visible, and vice versa.
Location	The Tech. analysis window area, where the chart is located. The areas are arranged by sequence top to bottom. If a chart is hidden, its area is not listed.
Series	Series chart ticker, which the indicator belongs to – the Name column value in the Series tab.

9.7.3. Drawings tab

The **Drawings** tab of the **Object manager** window contains all additional graphical objects for all charts added into the current **Tech. analysis** window.

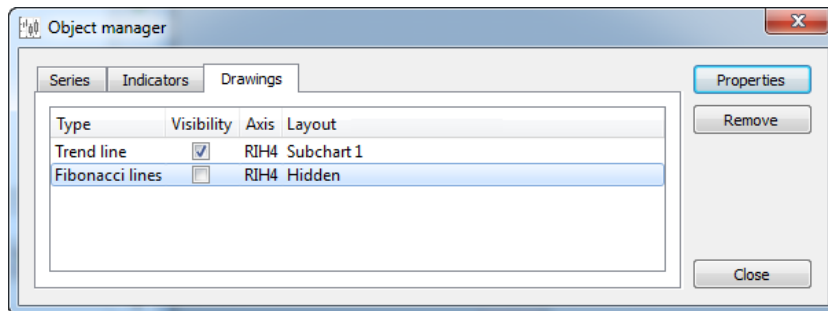

Fig. 9.25. Object manager. Drawings.

Tab. 9.6. Parameters in the Drawings tab (Object manager)

Parameter	Details
Type	Types of graphical objects: <ul style="list-style-type: none"> • trend line; • horizontal line; • Fibonacci lines, arcs, fans.
Visibility	Object visibility option in the Tech. analysis window. When option is enabled, the object is visible, and vice versa.

Parameter	Details
Axis	Ticker of the vertical axis, to which the object is pinned.
Location	The Tech. analysis window area, where the object is located. The areas are arranged by sequence top to bottom. If an object is hidden, its area is not listed.

9.8. Indicator editor

You can edit indicator code or create a new code via the **Tech. analysis/ Indicator editor** main menu item or by pressing the **Shift+E** key combination.

The Indicator editor window consists of two tabs:

- Indicators;
- Functions.

To work with indicators or with functions, click the appropriate tab.

The indicators and functions code is written using an advanced version of **QScript**.

9.8.1. Indicator code editor

You can edit indicator code or create a new code via the **Tech. analysis/ Indicator editor** main menu item in the **Indicators** tab.

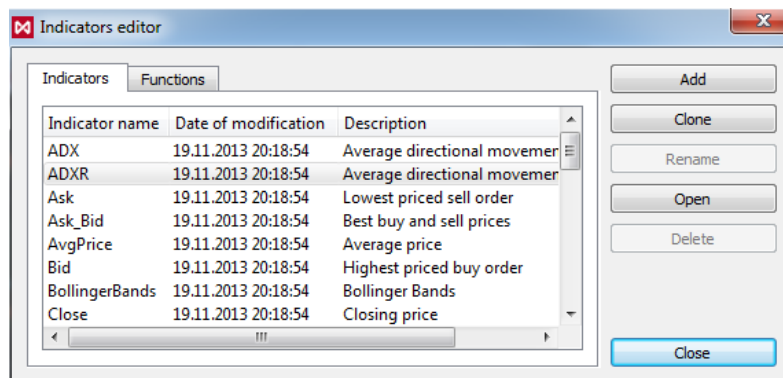

Fig. 9.26. Indicator code editor

Initially, you have a set of standard indicators installed together with the application, but you are able to add some more user created indicators. Every indicator has its own name, date of last modification and a brief description.

You cannot edit or delete standard indicators, that is why the **Rename** and **Delete** buttons are disabled for them. If you do need to edit a standard indicator, you can clone it (the **Clone** button) and then edit the cloned indicator as any other user created one.

The **Open** button allows to view code of standard indicator. For user created indicators, you can view and also edit their code.

After you added some more indicator files into the appropriate file folder on your computer, please reopen the **Indicator editor** window (fig. 9.26) to make the new indicators displayed.

To work with the indicators list, please use the buttons in the right side of the window - fig. 9.26.

To add a new indicator in the list use the **Add** button. A window will appear on the screen, where you should enter a new indicator name and press **OK**:

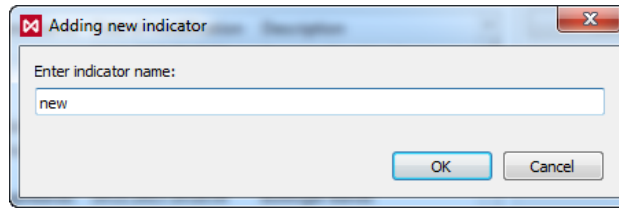

Fig. 9.27. Adding a new indicator

In the next window, you should add the indicator function code and a brief description:

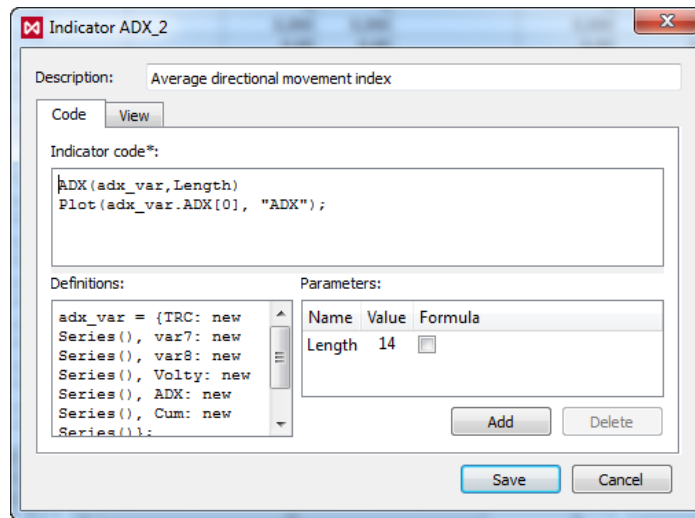

Fig. 9.28. Entering indicator code

The **Description** field is not mandatory and may remain empty.

The **Indicator code** field in the **Code** tab is used for entering the indicator code in **QScript** language (the ECMA standard) extended with the elements necessary for programming indicators. You can know more about the ECMA standard language constructions and syntax at <http://www.ecma-international.org/publications/standards/Ecma-262.htm>. To know more about **QScript** see section 9.8.3.

The **Indicator code** is mandatory, that is why it is marked with asterix. The **Save** button remains disabled until you entered something onto the **Indicator code** field. After you clicked the Save button, the new indicator will be saved and displayed in the list in the top position - fig. 9.28.

The script code entered into the **Indicator code** field executes for every bar of the chart.

The **Definitions** field contains commands, which execute only once, at start (for example, a variable declaration command).

The **Parameters** field allows you to set or edit some parameters values. The parameters values set there are used as the default values for this indicator. To add or delete a parameter value, please use the **Add** and **Delete** buttons, respectively.

You can also use formulas as parameters: for example, **Formula** (in the **Name** field) - **Close[0]-Close[1]** (in the **Value** field), the **Formula** check-box must be checked in. After that, the formula will be executed for every bar of the chart (repeatedly). Please note, that if the **Formula** check-box is not checked, the formula will execute only once. This may lead to erroneous indicator value calculation.

To edit code in any area of the window, please use the standard keys such as **Enter** or **Backspace**. To enable the edit mode in the **Parameters** area, double-click a field (**Name** or **Value**) with the left mouse button.

The **View** tab for indicator charts is used to specify the indicators style and location parameters - see fig. 9.29:

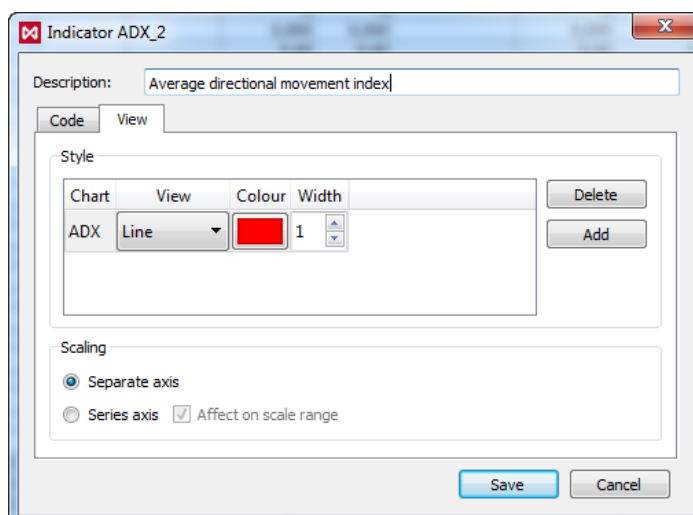

Fig. 9.29. Chart style indicator

You can specify the following parameters for every indicator:

- **Chart** – the indicator chart name. To edit the value, double-click it with the left mouse button. One indicator may have several charts;
- **View** – chart style (line, histogram or dots). To select a value, double-click the table cell with the left mouse button and select a value in the drop-down list;
- **Colour** – chart colour scheme. To select a new colour, click it in the palette, and make the appropriate actions using the standard **Select Color** window;
- **Width** – width of indicator chart lines;
- **Scaling** – location, to where the chart of the indicator will be added by default:
 - **Separate axis** - the indicator chart will be added into a new separate area in the current **Tech. analysis** window;
 - **Series axis** – the indicator chart will be added into the area containing the series chart and pinned to the series axis.
 - **Affect scale range** - this option is available only if the indicator chart is pinned to the same axis with the series chart. When the option is enabled, the automatic scaling will affect both series and indicator charts. When the option is disabled, the automatic scaling option will affect the series chart only. This may lead the indicator chart to be 'lost' beyond the window borders.

To save the changes click **Save**, to exit without saving click **Cancel**.

The **Clone** button (fig. 9.26) is used to duplicate an existing indicator. To duplicate an indicator, place the mouse cursor on the indicator name and click **Clone**. A window, containing the indicator name (same as fig. 9.27) will appear on the screen. By default, the new indicator is named after the source indicator, for example **Clone_2**. The name can be changed. The new indicator with the new name will be displayed in the indicator list. Please note, that code of the new indicator will be fully equal to that of the source indicator.

The **Rename** button (fig. 9.26) allows to rename an indicator in the list. To do this, place the mouse cursor on the appropriate indicator name, click the **Rename** button and enter a new indicator name, then click **OK** - fig. 9.27.

The **Open** button allows to change indicator code, its description or visual style. To do this, place the mouse cursor on the appropriate indicator name and click the **Open** button. A window will appear on the screen, where you will be able to edit the indicator code, description and style. After editing is complete, click **Save** - fig. 9.28. Also, you can switch to the edit mode by double-clicking the indicator name in the list with the left mouse button.

The **Delete** button (fig. 9.26) allows to delete an indicator from the list. Before deleting, you will receive the confirmation dialog: 'Are you sure you want to delete indicator?'. To confirm deletion, click **Yes**, to cancel click **No**.

The **Close** button (fig. 9.26) closes the **Indicator editor** window.

9.8.2. Functions editor

For your convenience, you can use functions for programming indicators. To edit code of an existing function or program a new function, use the **Tech. analysis/ Indicator editor** main menu item in the **Functions** tab.

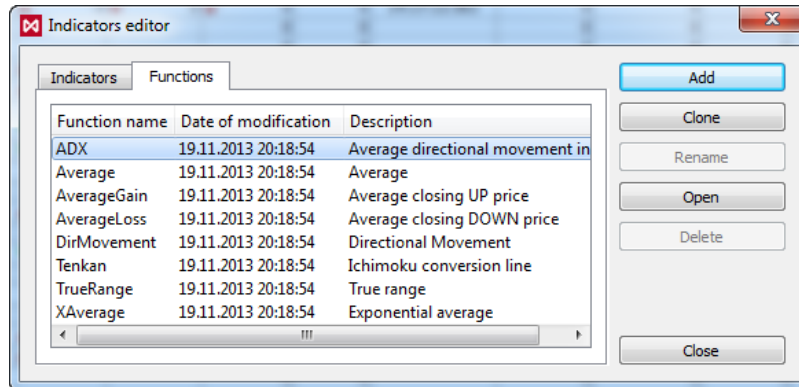

Fig. 9.30. Functions editor

Initially, you have a set of standard functions installed together with the application, but you are able to add some more user created functions. Every function has its own name, date of last modification and a brief description.

To work with the functions list, please use the buttons in the right side of the window - fig. 9.30.

To add a new function in the list use the **Add** button. A window will appear on the screen, where you should enter a new function name and press **OK**:

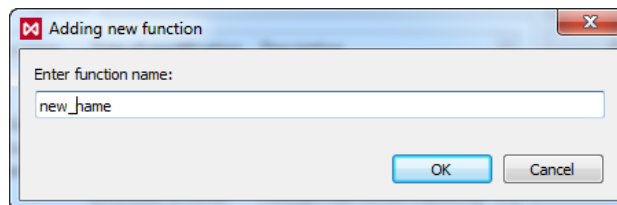

Fig. 9.31. Adding a new function

Then, the window for will appear on the screen, where you should enter the function code and its description:

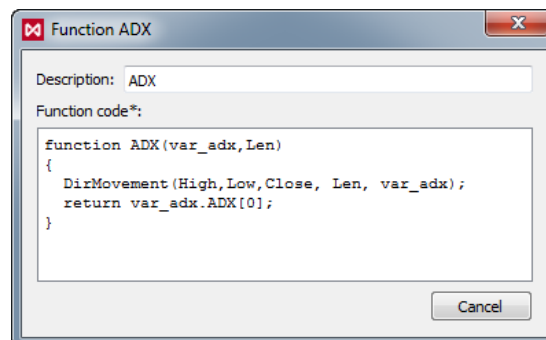

Fig. 9.32. Entering function code

The **Description** field contains the function description, and is not mandatory.

The field below contains the function code, and is mandatory. You can enter and edit code right in the field using the standard keyboard keys.

After clicking the **Save** button, the function will be saved and appear in the top of the functions list - fig. 9.30.

The **Clone** button (fig. 9.30) is used to duplicate an existing function. To duplicate a function, place the mouse cursor on the function name and click **Clone**. A window, containing the function name (same as fig. 9.31) will appear on the screen. By default, the new function is named after the source function, for example **DirMovement_2**. The name can be changed. The new function with the new name will be displayed in the indicator list. Please note, that code of the new function will be fully equal to that of the source function.

The **Rename** button (fig. 9.30) allows to rename an function in the list. To do this, place the mouse cursor on the appropriate function name, click the **Rename** button and enter a new function name, then click **OK** - fig. 9.31.

The **Edit** button allows to edit the function name or its description. To do this, place the mouse cursor on the function name and click **Edit**. When editing is complete, click the **Save** button – fig. 9.32

The **Delete** button (fig. 9.30) allows to delete a function from the list. Before deleting, you will receive the confirmation dialog: 'Are you sure you want to delete the function?'. To confirm deletion, click **Yes**, to cancel click **No**.

The **Close** button (fig. 9.30) closes the **Indicator editor** window.

9.8.3. QScript language extension

QScript language has been used for programming indicators and functions. It is fully complied with the **ECMA** standard specifications.

You can know more about the ECMA standard language constructions and syntax at <http://www.ecma-international.org/publications/standards/Ecma-262.htm>.

QScript language has been extended and used as a basis for programing indicators. The available **QScript** constructions are listed in tab. 9.7.

Indicator - one or several arrays, which are filled upon execution of script.

Script code executes for each bar.

Important notice! The bar number, the script is executing for, is said to be the current.

Tab. 9.7. QScript language extension

Element	Details
Arrays	
Array[n]	<p>Array cell access by index '<i>current bar - n</i>'.</p> <p>If n is</p> <ul style="list-style-type: none"> • a positive value, then the offset is n bars to the past starting from from the current bar; • a negative value, then the offset is n bars to the future starting from from the current bar; • is '0', then the current bar is processed. <p>Example:</p> <p><i>Close[0]</i> - closing price for the current bar;</p> <p><i>Close[1]</i> - closing price for the previous bar;</p> <p><i>Close[5]</i> - closing price for the bar which is 5 bars earlier than the current one;</p> <p><i>Close[-1]</i> - closing price for the next bar.</p>
Series	<p>Creates a new array to be used later in the Definitions area (see fig. 9.28).</p> <p>Example:</p>

Element	Details
	<i>var x0 = new Series()</i> - new array declaration.
Close	Array, where elements are the closing price values of the appropriate bar. <i>Close[n]</i>
Open	Array, where elements are the open price values of the appropriate bar. <i>Open[n]</i>
High	Array, where elements are the maximum price values of the appropriate bar. <i>High[n]</i>
Low	Array, where elements are the minimum price values of the appropriate bar. <i>Low[n]</i>
Value	Array, where elements are the volume in money values of the appropriate bar. <i>Value[n]</i>
Volume	Array, where elements are the quantity in lots/units of the appropriate bar. <i>Volume[n]</i>
OI	Array, where elements are the quantity of the open positions/open interest of the appropriate bar.. <i>OI[n]</i>
Functions	
Plot	Saves values in the array cell. <i>Plot(a, "name")</i> a - value to be saved in the array cell; "name" - array name. This name is used for indicator chart in the View tab (fig. 9.29) - to define appearance of the array. Example: <i>Plot(Close[0], "Close")</i> - the closing price value of the current bar is saved into the Close array.
Cloud	Specifies area for hatching if the indicator chart consists of several lines. This function can be declared only once, i.e. saved into the Definitions area (fig. 9.28). <i>Cloud("name1", "name2")</i> <i>name1</i> and <i>name2</i> - to hatch the area between these indicator lines. The color is taken from the upper line color settings. Example: <i>Cloud("Senkou Span A", "Senkou Span B")</i> - are used in the Ichimoku indicator. Area between the lines <i>Senkou Span A</i> and <i>Senkou Span B</i> will be hatched.
Level	Adds a straight line to to the level defined by this variable. Adds a new line every time the level value is recalculated. <i>Level(a, "name")</i>

Element	Details
	<p><i>a</i> - variable value;</p> <p><i>name</i> - variable name.</p> <p>Example:</p> <p><i>Level(bid, "Bid")</i> - the best buy price value is used. The indicator line name is Bid.</p>
SetOutRunning	<p>Specifies indicator outrun value to draw and indicator chart 'in future'. Used for forecasting.</p> <p><i>SetOutRunning(n)</i></p> <p><i>n</i> - number of bars to the future starting from the current one to execute the indicator code for. Can be specified either by number or by variable (declared in other section).</p> <p>Example:</p> <p><i>SetOutRunning(10)</i> - the indicator code will be executed 10 bars to the future starting from the current bar;</p> <p><i>SetOutRunning(KijunPeriod)</i> - the indicator code will be executed for the number of bars specified in the <i>KijunPeriod</i> parameter to the future starting from the current bar.</p>
SetDelay	<p>Specifies the indicator chart delay value. The indicator line in this case may end earlier than the series chart. This indicator is calculated based on the future charts data.</p> <p><i>SetDelay(n)</i></p> <p><i>n</i> - number of bars to the past starting from the current one to execute the indicator code for. Can be specified either by number or by variable (declared in other section).</p> <p>Example:</p> <p><i>SetDelay(10)</i> - the indicator line will end 10 bars earlier than the series chart;</p> <p><i>SetDelay(KijunPeriod)</i> - the indicator line will end earlier for the number of bars specified in the <i>KijunPeriod</i> parameter than the series chart.</p>
CurrentBar	<p>Specifies the valid current bar. Equal to the bar number, for which the script is executing. Only valid bars starting from the beginning of the series are counted!.</p> <p><i>CurrentBar(n)</i></p> <p><i>n</i> - number of the current bar</p> <p>Example:</p> <p><i>if (CurrentBar(n) >= Length)</i> - the number of the current bar is compared to the <i>Length</i> variable. The resulting values can be used for some future needs.</p>
Financial instrument parameters - instrument's characteristics. Not an array.	
ask	Best sell order price.
bid	Best buy order price.
price_lmt_high	Price upper limit.

Element	Details
<code>price_lmt_low</code>	Price lower limit.
<code>max_price</code>	Maximum price.
<code>min_price</code>	Minimum price.
<code>price</code>	Closing trade price .
<code>avg_price</code>	Closing trade price .
<code>cur_kotir</code>	Closing trade price .
<code>old_kotir</code>	Previous session settlement price.
<code>open_price</code>	Opening price.
<code>close_price</code>	Opening price.
<code>theor_price</code>	Option theoretical price.
<code>last_cl_quote</code>	Option theoretical price.
Variables	
Math	<p>An object, containing a mathematical function.</p> <p><i>Math.Funk(x)</i></p> <p><i>Funk(x)</i> - mathematical function name and parameters.</p> <p>Example:</p> <p><i>Math.sqrt(m)</i> - Square root calculation.</p>

For better understanding, it is recommended to study this user manual along with the terminal application.

9.9. Chart settings

All new charts use the general settings made via the **Settings/ Terminal settings/ Charts and TA.** main menu item. Also, you can open the general settings window using the **Ctrl+**, key combination. These settings will be used as the default settings for all **Tech. analysis** windows.

You can change settings for already added charts by the following ways:

- via the **Properties** context menu item (see section 9.3). You should select a chart before opening the context menu. The settings made via the context menu will be applicable for the selected chart only;
- via **Object manager** (see section 9.7). You should select a chart first, after that, press the **Properties** button. These settings will be applicable for the selected chart only.

The **Apply** button allows to save the changes you made, without closing the window. The **Cancel** button closes the window without saving the changes, while **OK** saves the changes and closes the **Settings** window.

Sometimes it may be necessary to reopen the **Tech. analysis** window. In this case, you will receive an information message.

For the current window containing charts, you can change the main colour settings using the **Window settings** window (also, you can open it by pressing the **Ctrl+E** key combination). Please note, that these settings will be lost after closing the window. If you want to save the current settings of the **Tech. analysis** window for all windows of this type, you can use the **Current window/ Save by default** main menu item. After that, the main window settings (location, size, data stamp, grid and colour scheme) will be the same for every new opened window containing charts.

9.9.1. Confirmation settings for charts

You can set up confirmation dialog settings for some actions with charts via the **Confirmations** tab (the **Settings/ Terminal settings/ Charts and TA** main menu item).

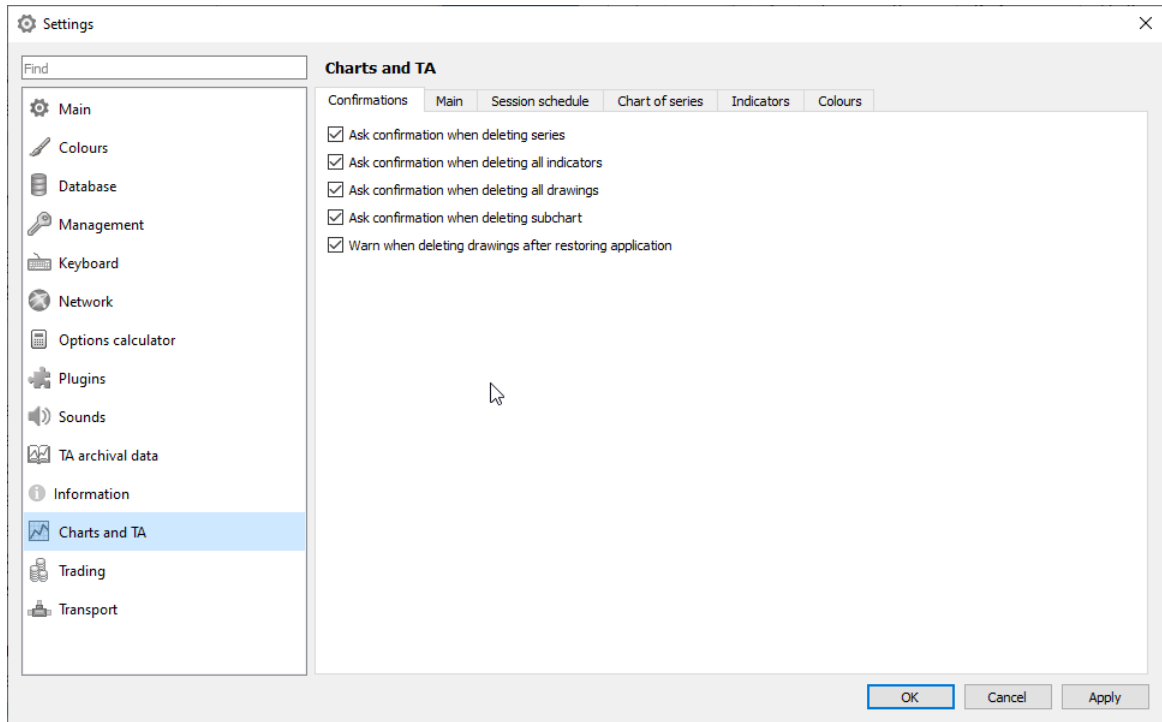



Fig. 9.33. Charts and TA. The Confirmations tab.

Tab. 9.8. Parameters in the Confirmations tab

Parameter	Details
<p>Series deletion confirmation</p>	<p>When the option is enabled, you will receive the confirmation dialog message before deletion a series:</p> <ul style="list-style-type: none"> • 'Are you sure you want to delete chart? All indicators based on this series will be also deleted' – for charts; • «'Are you sure you want to delete indicator?' – for indicators. <p>Answer:</p> <ul style="list-style-type: none"> • Yes – to confirm deletion; • No – to cancel deletion. <p>The Do not show next time option allows to disable the confirmation dialog. In this case, the charts will be deleted immediately after pressing OK.</p>
<p>All indicators deletion confirmation</p>	<p>When the option is enabled, you will receive the confirmation dialog message before deletion a series (the  button of the instrument panel): 'Are you sure you want to delete all indicators from the window?'</p> <p>Answer:</p> <ul style="list-style-type: none"> • Yes – to confirm deletion; • No – to cancel deletion. <p>The Do not show next time option allows to disable the confirmation dialog. In this case, the indicators will be deleted immediately after pressing OK</p>

Parameter	Details
<p>All graphical objects deletion confirmation</p>	<p>When the option is enabled, you will receive the confirmation dialog message before deletion a series (the  button of the instrument panel): <i>'Are you sure you want to delete all drawings from the window?'</i></p> <p>Answer:</p> <ul style="list-style-type: none"> • Yes – to confirm deletion; • No – to cancel deletion. <p>The Do not show next time option allows to disable the confirmation dialog. In this case, the graphical objects will be deleted immediately after pressing OK</p>
<p>Area deletion confirmation</p>	<p>When the option is enabled, you will receive the confirmation dialog message before deletion an area containing some objects: <i>'Are you sure you want to delete the area? All objects in the area will be also deleted'</i>.</p> <p>Answer:</p> <ul style="list-style-type: none"> • Yes – to confirm deletion; • No – to cancel deletion. <p>The Do not show next time option allows to disable the confirmation dialog. In this case, the area with its objects will be deleted immediately after pressing OK.</p>
<p>Warn when deleting drawings after restoring application</p>	<p>When the option is enabled, you will receive the confirmation dialog message: <i>'Tech. analysis: Some graphical objects were placed out of displayed range and have been deleted'</i>.</p> <p>This situation may occur when the chart contains some graphical objects out of the displayed range.</p> <p>The Do not show next time option allows to disable the confirmation dialog. In this case, the graphical objects will be deleted immediately after pressing OK.</p>

By default, all the options are enabled.

9.9.2. Loading data from ISS. Setting bar location

You can set some main parameters via the **Main** tab (**Settings/ Terminal settings/ Charts and TA** main menu item).

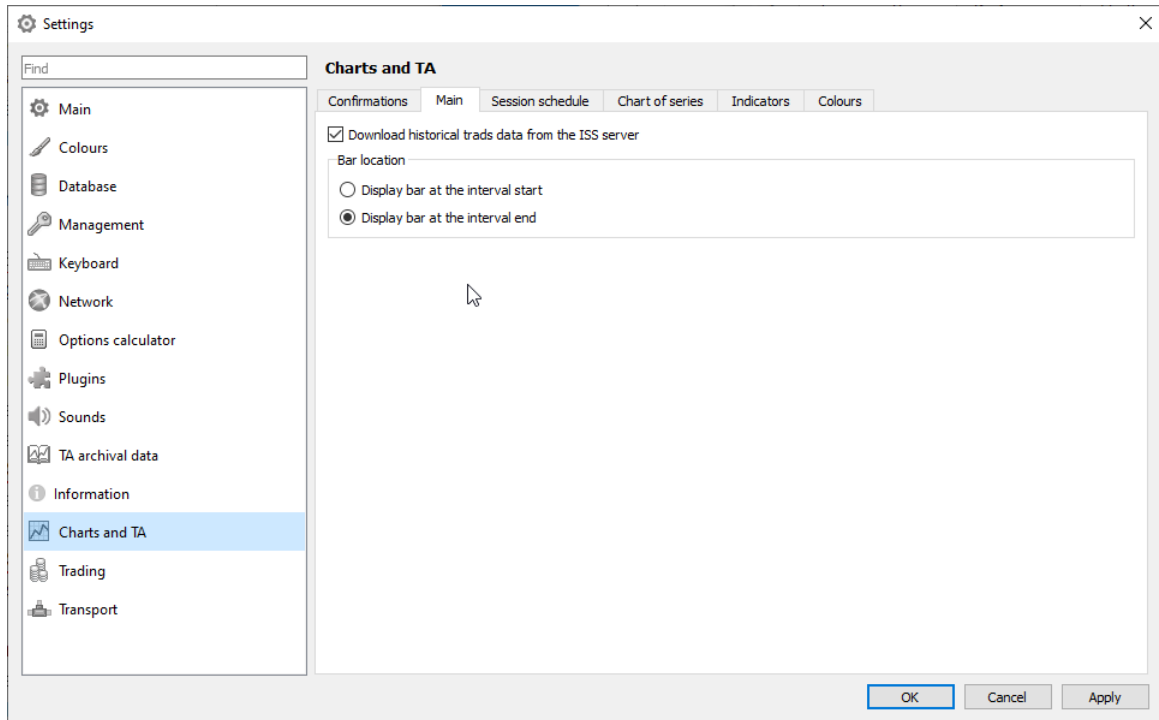

Fig. 9.34. Charts and TA. The Main tab.

Download historical trades data from the ISS server - by default, this option is enabled

The Technical analysis data is obtained from trades aggregated into time-frames (1 second and 60 seconds intervals).

To create charts using archival data, you can load data from the information-statistics server (ISS), via the HTTP protocol.

Parameters of connection to ISS server are set in **ISS service** tab (**Settings/ Terminal settings** main menu item of the **Transport** section) - see section 10.17.2.

Currently the data are available for:

- futures and options market;
- securities market except:
- currency market, ETC instruments;
- indices, with the following restrictions:
 - data availability is limited up to the yesterday's date data,
 - the indicative currency indices are not available for downloading from the ISS (for example, USDFIX).

Data for the expired instruments are not loaded. The data is aggregated into time frames of around 1 minute.

Independently on the current data load status, the trading terminal makes attempt to load some already received data stored on disk. In case of their absence, the trading terminal makes attempt to load from disk aggregated trades data. This algorithm is used every trading day, within the user specified time interval.

Setting bar location - you can set bar location either at the start of its interval or at the end by selecting the appropriate option. This setting is global, i.e. it is applicable to all the newly opened **Tech. analysis** windows. To apply the settings to already opened window, you should reopen them.

9.9.3. Session schedule

You can setup trading sessions schedule by days including session halts via the **Settings/ Terminal settings** main menu item via the **Charts and TA** section of the **Session schedule** tab. Also, you can open this window by pressing the **Ctrl+**, key combination.

The trading sessions schedule is used in charts, in order to exclude inactive time periods (session gaps, night time, weekends and holidays) from the chart lines. The time period will be skipped, and chart parts for active time periods will be stitched together. The stitch line is marked with dash line.

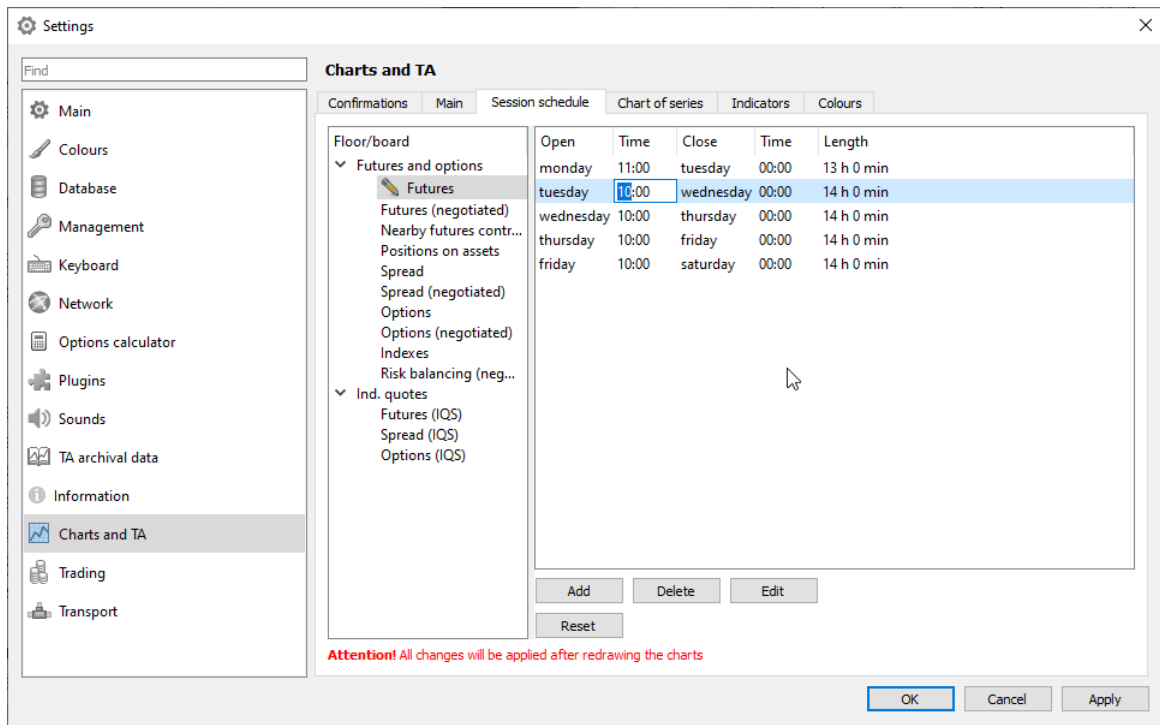

Fig. 9.35. Charts and TA. The Session schedule tab.

Tab. 9.9. Parameters in the Session schedule tab

Parameter	Details
Floor/ board	Floor/board name.
Open	Opening day.
Time	Opening time.
Close	Closing day.
Time	Closing time.
Length	Trading interval in hours and minutes.

By default, the schedule is set for all boards and all floors.

You can setup separate trading session schedules for each floors and boards. To do this, select a board in the appropriate list at the left side, click **Edit**, make all necessary changes and click (**OK** or **Apply**). The board name in the list, for which the schedule has been edited, is marked with . The **Reset** button allows to reset the separate schedule and get back to the global schedule settings, which is the same for the whole floor.

The **Apply to boards** button allows to apply the current schedule for all trading boards.

The **Edit**, **Add** and **Delete** buttons allow to edit, add and delete records in the schedule.

There is a special window for editing existing records and adding new ones.

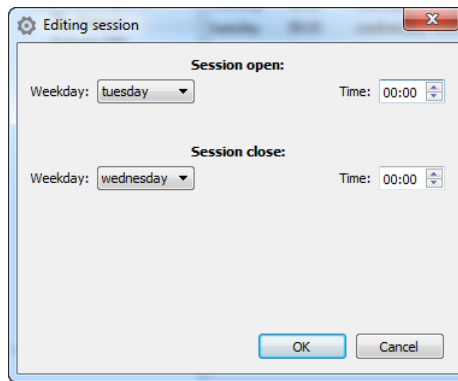

Fig. 9.36. Editing session parameters for charts

Also, you can open this window by double-clicking a records with the left mouse button.

You can edit the trading session open and close time right on the **Session schedule** page (see fig. 9.35). To do this, double-click an appropriate field in the **Time** column, edit the value there and press **Enter**.

Time intervals of trading sessions cannot overlap each other. Once this situation occurs, you will receive the appropriate warning message. Each trading session cannot last more than 24 hours. Also, the session closing time cannot be earlier than the session opening time.

To apply the changes you have made to schedule parameters, you should reopen the **Tech. analysis** window.

9.9.4. Series charts settings

You can setup the general preferences of series charts using the **Settings/ Terminal settings/ Charts and TA** main menu item, in the **Chart of series** tab (or by pressing the **Ctrl+**, key combination). The settings you will make there will be used for all **Tech. analysis** windows as the default settings.

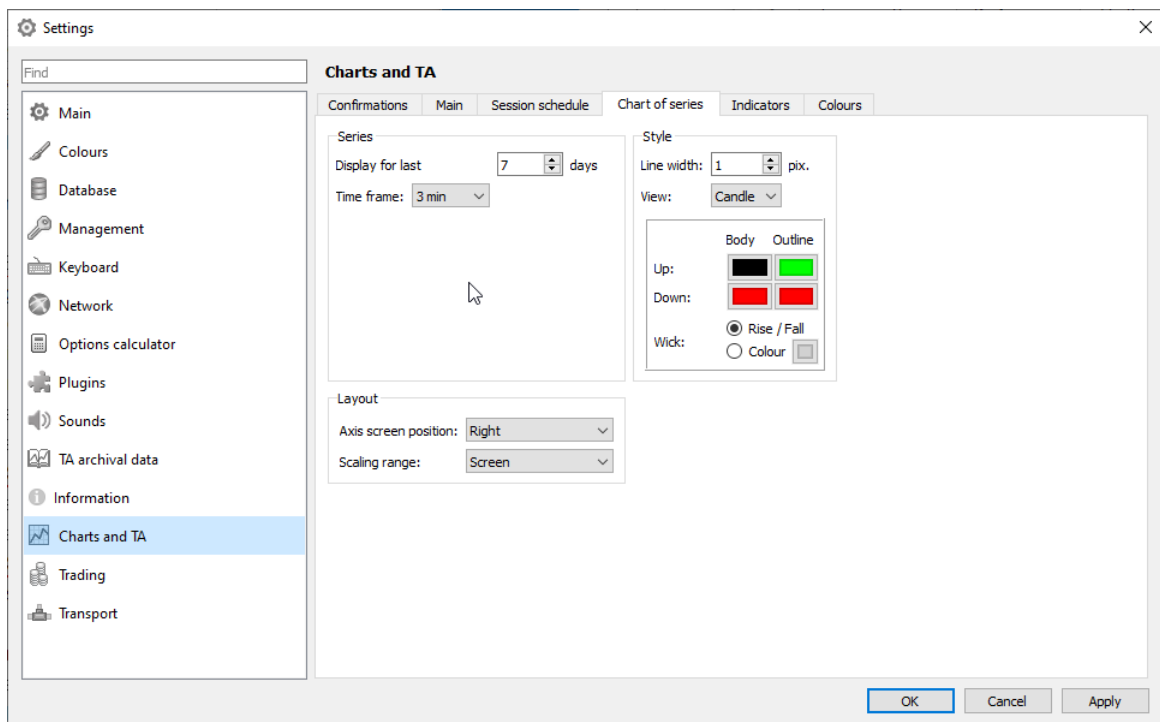

Fig. 9.37. Charts and TA. The Series chart tab.

Tab. 9.10. Parameters in the Chart of series tab

Parameter	Details
Series	
Display for last	Chart display period in days before the current date. 1 means the current day, 2 means yesterday and today, etc.
Time frame	Data aggregation period. The value can be selected from the drop-down list. For the selected period of time all trades are aggregated. Then, the outcoming price is analyzed. The time frame also defines the horizontal axis pitch.
Layout	
Axis screen position	The vertical axis location: <ul style="list-style-type: none"> • right • left • both side • invisible axis
Scaling range	Chart scaling: <ul style="list-style-type: none"> • entire series – chart is be scaled according to the current window size in order to display all extremal points; the vertical axis does not change along the entire chart. • screen – only visible part of the chart is be scaled. The start and end values are zoomed in and out depending on displayed part of the chart.
Style	
Line width	Series chart lines width, used for all series chart by default.
View	Chart type: <ul style="list-style-type: none"> • candle • bar • line
Candles settings	
Up	Candle colour when value is increasing if the incoming price value is lower than the outcoming one. The default colour is green. You can change the candle body colour (Body) and its outline colour (Outline). To change colour please click the colour you need to open the Select Color window.
Down	Candle colour when value is decreasing if the incoming price value is higher than the outcoming one. The default colour is red. You can change the candle body colour (Body) and its outline colour (Outline). To change colour please click the colour you need to open the Select Color window.
Wick	Wick colour (straight line from the minimum value to the maximum one). <ul style="list-style-type: none"> • Rise/Fall - when the option is enabled, the wick colour will be equal to that of the rise/fall contour.

Parameter	Details
	<ul style="list-style-type: none"> • Colour - making this option enabled allows you to select the wick colour at your choice. To change the colour, click the colour box with the left mouse button - the standard window Select Colour will appear on the screen. Please note, that wick colours of the rise will be the same.
Bar settings	
High/Low	Straight line colour – from min till max. To change colour please click the colour you need to open the Select Color window.
Open	Colour of the opening price dash. To change colour please click the colour you need to open the Select Color window.
Close	Colour of the closing price dash. To change colour please click the colour you need to open the Select Color window.
Line settings	
Close	Chart line colour. To change colour please click the colour you need to open the Select Color window.

9.9.5. Indicators settings

You can specify the general indicators settings via the **Settings/ Terminal settings/ Charts and TA** main menu item in the **Indicators** tab, or by pressing the **Ctrl+**, key combination. These settings will be used as the default settings for all indicator charts.

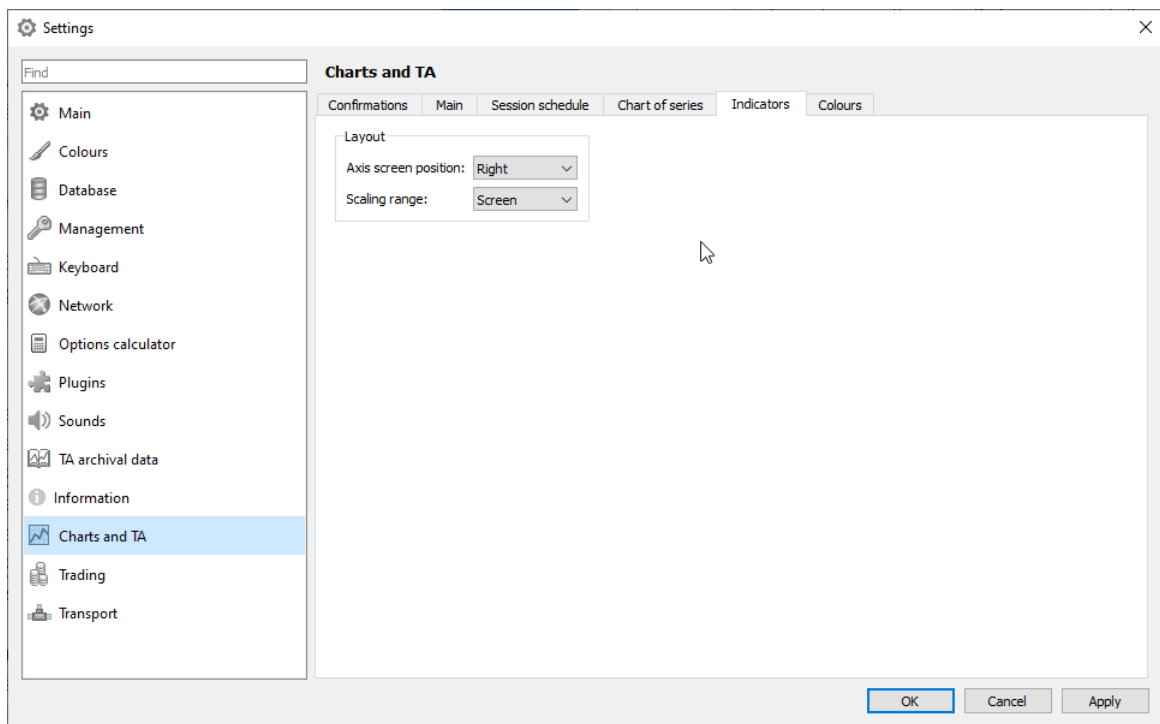

Fig. 9.38. Charts and TA. The Indicators tab.

Tab. 9.11. Parameters in the Indicators tab

Parameter	Details
	Location

Parameter	Details
Axis screen position	Vertical axis location on the screen: <ul style="list-style-type: none"> • right; • left; • both side; • invisible axis.
Scaling range	Chart scaling: <ul style="list-style-type: none"> • entire series – chart is be scaled according to the current window size in order to display all extremal points; the vertical axis does not change along the entire chart. • screen – only visible part of the chart is be scaled. The start and end values are zoomed in and out depending on displayed part of the chart.

9.9.6. Chart colour settings

You can specify the colour settings not only for chart, but also for some window elements like background, grid, axes and tags.

The general colour settings for the **Tech. analysis** window can be specified via the **Settings/ Terminal settings/ Charts and TA** main menu item in the **Colours** tab or by pressing the **Ctrl+**, key combination. These settings will be used as the default settings for all **Tech. analysis** windows.

For the current **Tech. analysis** window, you can specify colour settings via the **Window settings/ Colours** context menu item or by pressing the **Ctrl+E**. key combination. These settings will be applied to the current window only. The colour settings window is fully equal to fig. 9.39 , except the **Reset settings** button which allows to cancel the colour settings you made and get back to the default colour settings.

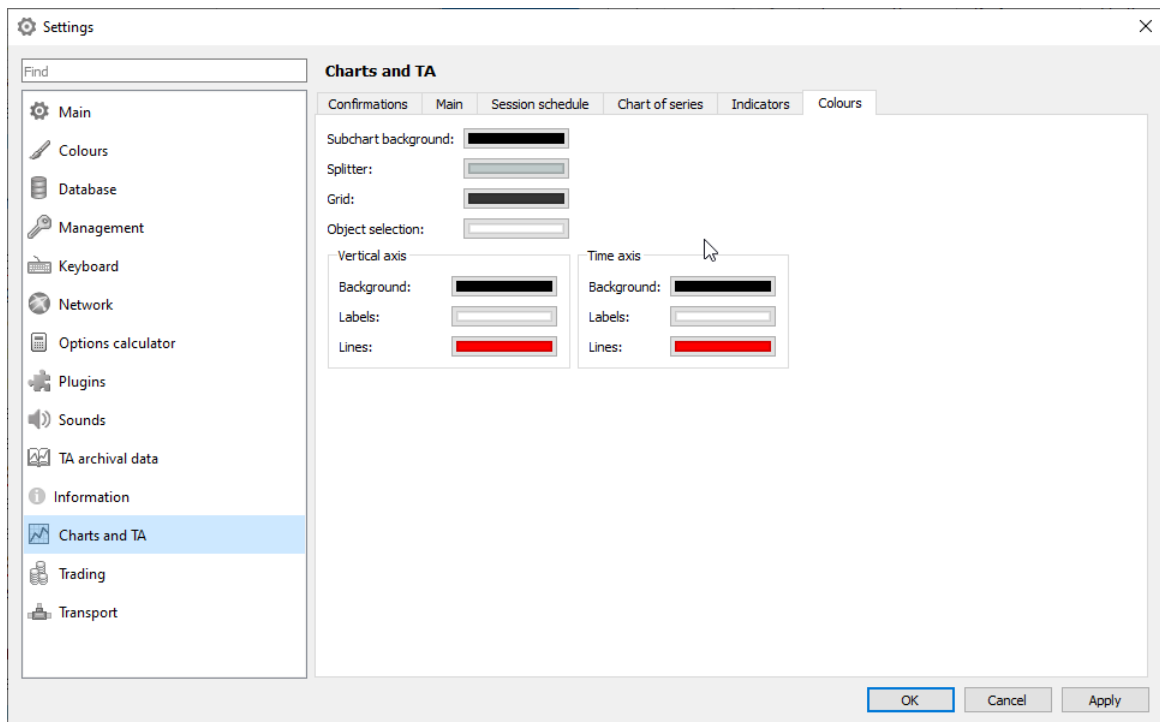

Fig. 9.39. Charts and TA. The Colours tab.

Tab. 9.12. Parameters in the Colours tab

Parameter	Details
Subchart background	Background colour – the main window field.
Splitter	Splitter lines colour.
Grid	Grid colour (if enabled).
Object selection	Chart dots colour (when a chart is selected).
Vertical axis	
Background	Vertical axes background colour.
Labels	Vertical axes tags colour.
Lines	Vertical axes scale colour.
Time axis	
Background	Time axis background colour.
Labels	Time axis tags colour.
Lines	Time axis scale colour.

9.9.7. Offset settings

Charts in the **Tech. analysis** window can be offset from the right window border. It can be useful when adding some forecasting indicator charts.

You can specify the offset parameters in the **Settings** window, which can be opened via the **Window settings** context menu item (**Ctrl+E** key combination) in the **Offsets** section. The offset value is set in bars, and calculated by the minimum time frame in the window.

9.10. Managing Technical analysis data

By the archival data for the **Tech. analysis** plugin we mean user data saved and stored separately from the main data. The user data are aggregated into time frames by minutes and seconds. The today's data are always retrieved from the **Your trades/ requests** table.

Storage parameters of the data aggregated into time frames by seconds can be set via the **Settings/ Terminal settings** main menu item of the **TA archival data** tab - see section 10.13. The **Remove obsolete archival files (1 second time frame) upon expiration ...days** option is enabled by default (7 days). This means that the 1 second time frame files will be deleted after 7 days of storing. You can specify the number of days for storing files, or disable the option. When the option is disabled, the archival 1 second time frame files will never be deleted from archive. This option is aimed to help controlling your disk space usage.

You can manage Technical analysis data in the following ways :

- import TA data;
- export TA data;
- edit TA data.

9.10.1. TA data import

Sometimes it may be necessary to import some data from an external source (like **Finam**, etc.).

You should fill in all mandatory fields in the data import application form. Please mind the following limitations:

- the only time frames allowed are 1 minute and 1 second;

- you must request **candle expiration time**.

The TA plugin allows to work with the TXT and CSV file formats.

The exported data are represented in the following way:

```

<TICKER>,<PER>,<DATE>,<TIME>,<OPEN>,<HIGH>,<LOW>,<CLOSE>
LK22,60,12/11/12,11:00:00,18967.00000,19038.00000,18913.00000,18944.00000
LK22,60,12/11/12,12:00:00,18945.00000,18992.00000,18880.00000,18932.00000
LK22,60,12/11/12,13:00:00,18927.00000,18995.00000,18850.00000,18905.00000
LK22,60,12/11/12,14:00:00,18909.00000,18970.00000,18902.00000,18947.00000
LK22,60,12/11/12,15:00:00,18956.00000,18966.00000,18923.00000,18935.00000
LK22,60,12/11/12,16:00:00,18939.00000,18958.00000,18930.00000,18936.00000
LK22,60,12/11/12,17:00:00,18940.00000,19018.00000,18940.00000,18990.00000
LK22,60,12/11/12,18:00:00,18996.00000,18997.00000,18951.00000,18991.00000
LK22,60,12/11/12,19:00:00,18991.00000,19050.00000,18938.00000,18938.00000
LK22,60,12/11/12,20:00:00,18967.00000,18972.00000,18850.00000,18866.00000
LK22,60,12/11/12,21:00:00,18865.00000,18902.00000,18860.00000,18890.00000
LK22,60,12/11/12,22:00:00,18897.00000,18982.00000,18865.00000,18982.00000
    
```

Fig. 9.40. Data structure

You can import external data into the trading terminal by the following methods:

- via the **Tech. analysis/ Manage TA data/ Import** main menu item;
- pressing the **Shift+I** key combination.

The **Manage TA data** plugin does not have any connection to the **Tech. analysis** one. Even if the **Tech. analysis plugin** is not activated, the **Manage TA data** menu items are available for using.

When importing data, the standard **Select a file** window appears on the screen, where you should select a data file. After that, the TA data import wizard window will appear.

The first page of the **TA data import wizard** (fig. 9.41) contains the series parameters, the data will be imported for. Every single file contains data only for a particular series (floor, trading board, instrument code, time frame).

The **Next** button will be inactive until all mandatory fields are filled in. The empty fields will be highlighted in red.

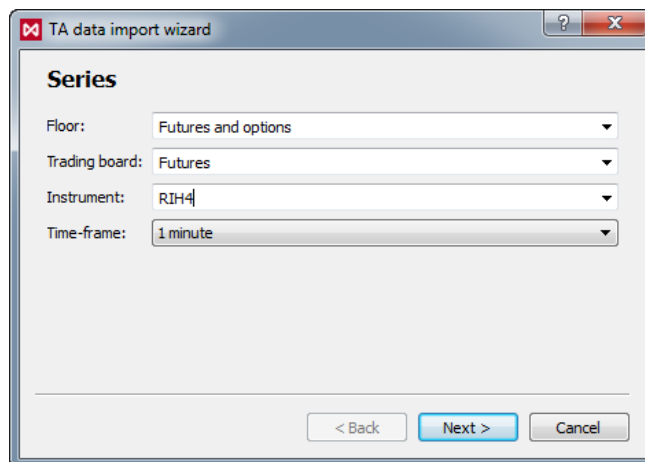

Fig. 9.41. TA data import wizard. Series.

After you filled in all the fields, press the **Next** button.

The next page of the **TA data import wizard** allows to specify the data format - see fig. 9.42.

On the bottom of the window there is the data structure of the imported file displayed. The **Format** page fields are filled in in accordance with the file data structure.

By default, the header flag is enabled. You should disable the flag if the imported file does not contain header.

Separators are used to break the data structure text in the bottom into columns according to separators.

The date and time format are set in accordance with the imported data format.

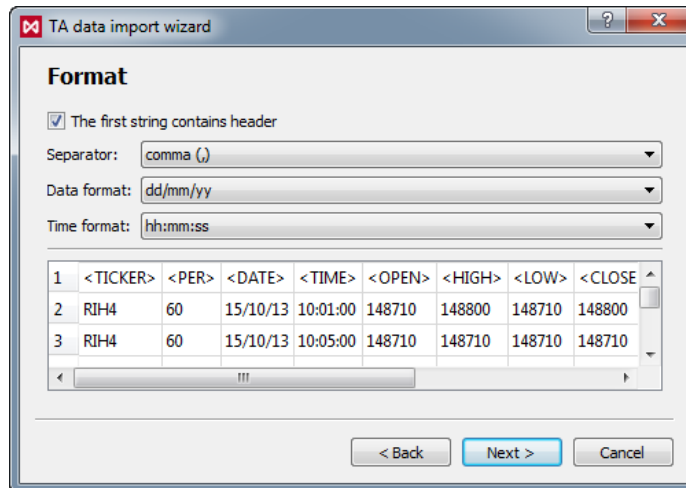

Fig. 9.42. TA data import wizard. Format.

After you filled in all the necessary fields, press **Next**.

On the next page of **TA data import wizard**, you should select columns to import data from - see fig. 9.43.

Every column header contains a drop-down list, where you should select a value. Otherwise, select **Do not imp.**, if you do not need to import these data. Every value can be selected only once.

The fields below are mandatory:

- **End date** - end date;
- **End time** - end time;
- **Op. price** - opening price for candle;
- **Max price** - maximum price for candle;
- **Min price** - minimum price for candle;
- **Cl. price** - close price for candle.

The **Volume** and **Open Int.** parameters are not mandatory.

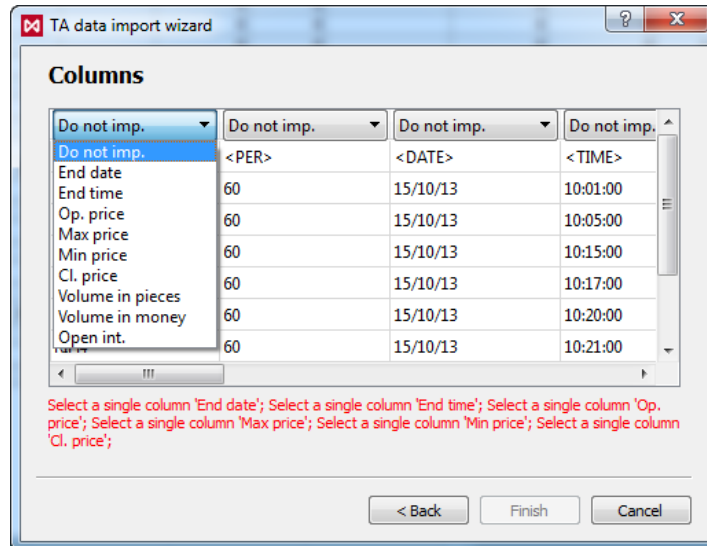

Fig. 9.43. TA data import wizard. Columns.

The mandatory fields are highlighted with red. After all the mandatory fields are filled in, the list below the table will disappear. To finish, press **Finish**.

In case of any error (incorrect file, import parameters error, etc.), the import will be canceled. You will receive the error message like below:

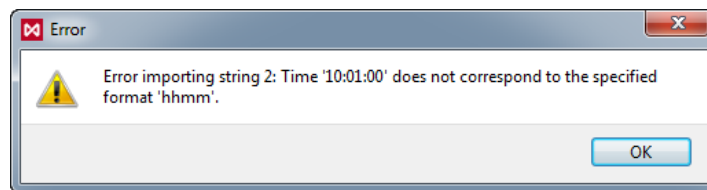

Fig. 9.44. Import error message

In this case, you should return to the initial step and try to refill all the fields correctly.

When import ended successfully, you will receive the following message: "TA data import completed successfully".

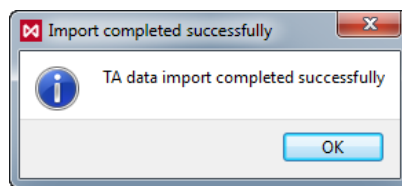

Fig. 9.45. Import completed successfully message

After that, you can open the **Tech. analysis** window and add charts using the imported data.

9.10.2. TA data export

In order to use some **Tech. analysis** data in third-party applications, you can export TA data into TXT files. Data from the **All trades/ requests** table will be aggregated and saved into the export file automatically. The export data contain the user's stored archival data and the current data from the **All trades/ requests** table.

You can export data using the following methods:

- via the **Tech. analysis/ Manage TA data/ Export** main menu item;
- pressing the **Shift+X** key combination.

On the first page of **TA data export wizard** you should specify the data export parameters (see fig. 9.46):

- **Floor** - trading floor name;
- **Trading board** - if you have not selected any trading floor yet, the drop-down list will contain all possible boards;
- **Instrument** - instrument code to export data for, according to the selected trading board;
- **Interval** - time interval to select data for. The end date must not be earlier than the start date. Also, the end date must not be later than the todays date;
- **Time-frame** - time-frame value;
- **Output file** - name of the output file. The name generates automatically according to the instrument code and time interval dates, but you can change it manually to any other name.

To select the output file format (TXT or CSV), you should click the arrow in the right side of the field;

- **Path** - path to save the output file. By default, the output files are stored into the folder containing the terminal application executable file.

The **Next** button stays inactive until you fill in all the mandatory fields. The empty fields will be highlighted in red.

Fig. 9.46. TA data export wizard. Series.

After you filled in all the fields, press **Next**.

The next page allows to specify the output file format - fig. 9.47.

Fig. 9.47. TA data export wizard. Format.

To finish, press **Finish**.

The data you selected will be exported to the specified file. If the export was completed successfully, you will receive the message: "TA data export completed successfully".

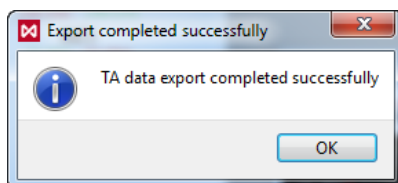

Fig. 9.48. Message window

In case of any error, you will receive an appropriate message. In this case, you should return to the initial step and try to refill all the fields correctly.

For the output file structure see fig. 9.40.

9.10.3. Editing TA data

You can edit saved TA data via the **Tech. analysis/ Manage TA data/ Edit** main menu item or by pressing the **Shift +D** key combination.

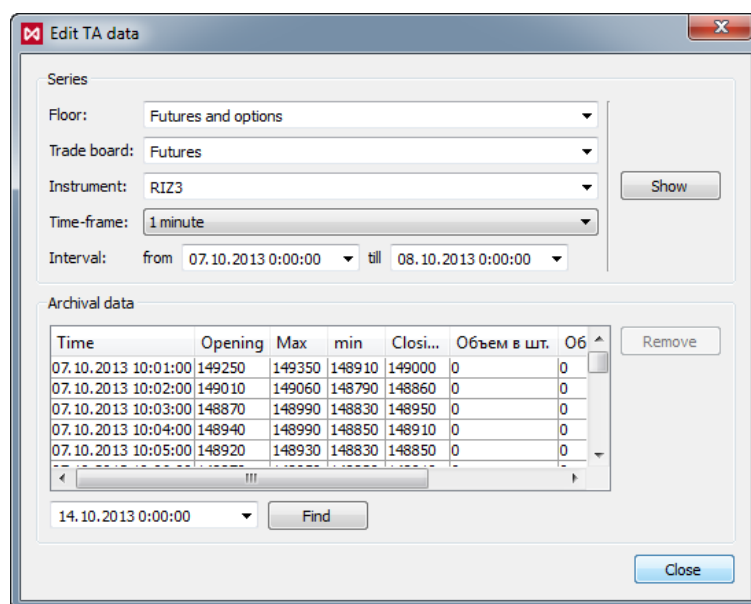

Fig. 9.49. The Edit TA data window

In the **Edit TA data** window you should specify the following parameters:

- **Floor** - trading floor name;
- **Trading board** - if you have not selected any trading floor yet, the drop-down list will contain all possible boards;
- **Instrument** - instrument code to export data for, according to the selected trading board;
- **Time-frame** - time-frame value;
- **Interval** - time interval to select data for. The end date must not be earlier than the start date. Also, the end date must not be later than the today's date;

The mandatory fields are highlighted in red. The drop-down lists contain only the trading floors, boards and instruments, for which some data has been saved for.

After you specified all the mandatory parameters, press **Show**. The stored data will be displayed in the **Archival data** section.

To find data by particular date and time, you can either enter the date and time you need in the field right under the main field or press the small black arrow and select the date and time in calendar. After that, press the **Find** button. The cursor will be placed to a record in accordance with the search parameters. If there is no record to match the search parameters exactly, the system will select another record with the time close to the specified.

The **Remove** button allows to delete the selected record. You can delete more than one record at once by selecting records using the **Ctrl** key. The **Shift** button allows to delete a group of consecutive records.

You cannot make any other action to the records, except deleting.

The **Close** button allows to close the **Edit TA data** window.

Chapter 10. Main settings

The **Settings/ Terminal settings** main menu item allows to specify your individual window settings in the most appropriate configuration:

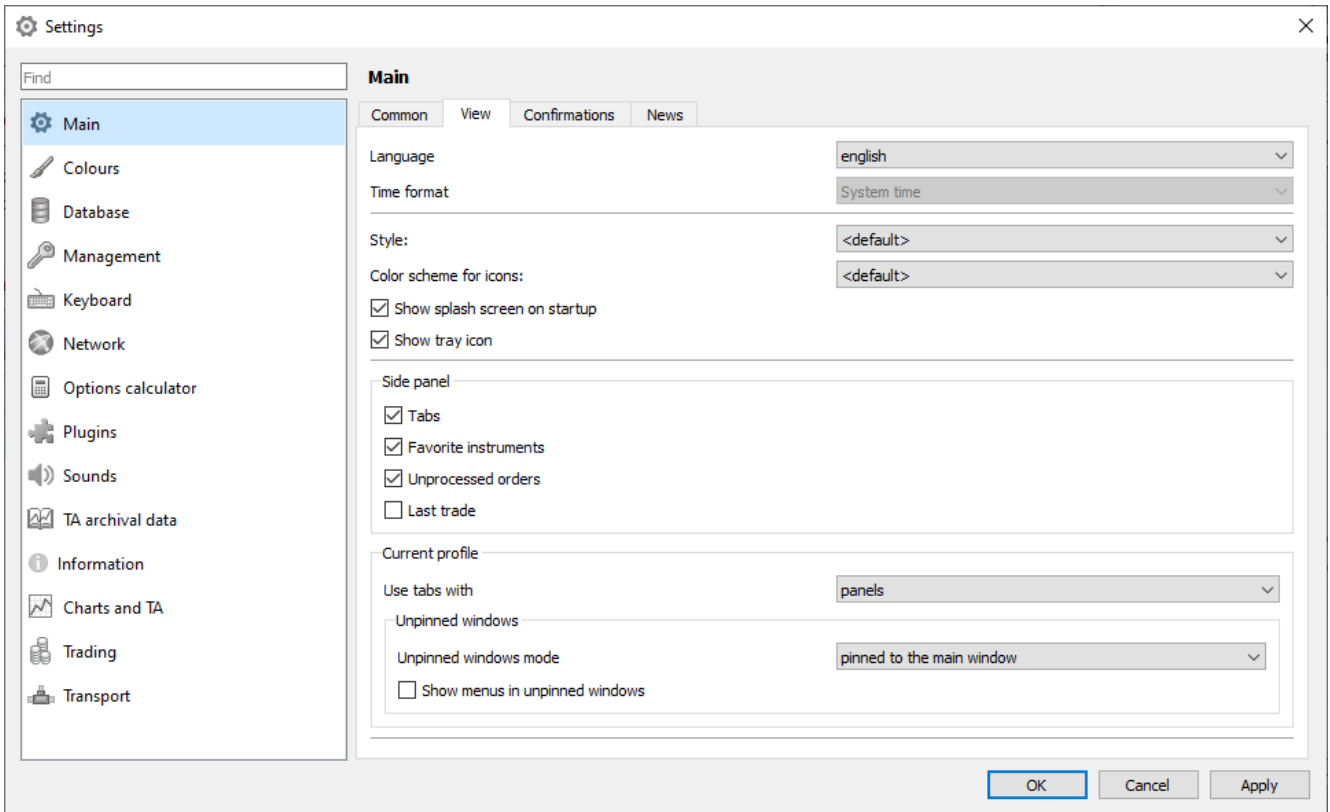

Fig. 10.1. Settings/ Terminal settings menu

You can specify the parameter settings by the following way:

- select a group of parameters in the left part of the window (see fig. 10.4) and click it with the left mouse button;
- the list of parameters belonging to selected group will be displayed in the right side of the window;
- specify the parameters settings or enable/disable them by checking/unchecking the appropriate checkboxes;
- press **Apply** to save the changes without closing the window, press OK to save the changes and close the window, or press Cancel to close the window without saving the changes.

All available values for each parameter can be selected in the appropriate drop-down list. Also, there are some parameter values (for example, amount/quantity) which can be entered manually via keyboard.

Please note, that in order to save the changes as the default, you should use the **Current window/ Save by default** option. Otherwise, all the changes will be lost after closing the trading terminal application.

10.1. Notification settings

For your convenience, you can enable the notification option, when a notification window will evoke in the system tray every time the trading system sends a new message to the participants. This notification window will disappear after 3 seconds.

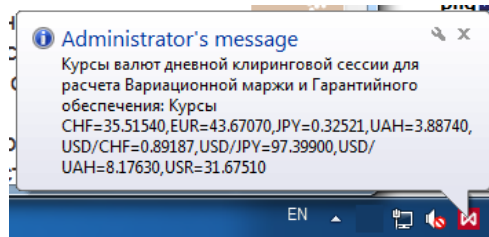

Fig. 10.2. Administrator's message notification

To set up the notification option, you should use the **Settings/ Terminal settings/ Main** main menu item in the **Common** tab:

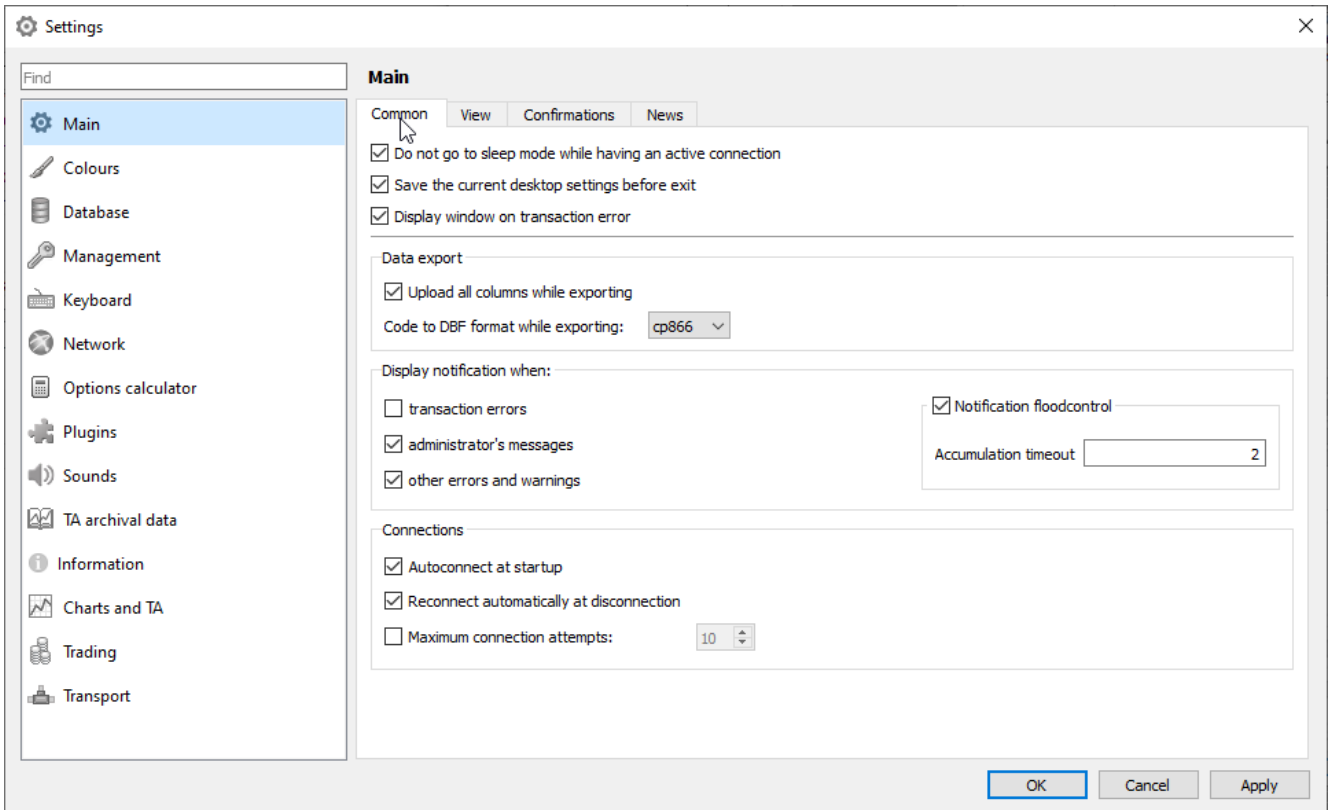

Fig. 10.3. Settings. The Main/ Common tab

Tab. 10.1. Parameters in the Common tab

Parameter	Details
Do not go to sleep mode while having an active connection	If the option is enabled (by default), your computer will not switch to the sleep mode active having the trading terminal application running.
Save the current desktop settings before exit	If the option is enabled (by default), the current desktop configuration will be saved before exit the application and loaded at the next application start. If the option is disabled, the last configuration saved as default will be loaded at the next application start.
Display window on transaction error	If the option is enabled (by default), then every time a transaction error occurs, the window containing the error details will appear on the screen.
Data export	
Upload all columns while exporting	Enabling this option allows you to download all the table's fields in default order. This means that all your actions with the table (hiding or moving columns) will be ignored, so that all columns will be exported, including the hidden ones.

Parameter	Details
	<p>If the option is disabled, only the visible columns will be exported. The order of exporting will be equal to that of the displaying on the screen.</p> <p>The option is enabled by default.</p>
Code to DBF format while exporting	<p>Allows to specify the exporting data charset of the DBF format.</p> <p>The following charsets are available to be selected in the drop-down list:</p> <ul style="list-style-type: none"> • cp866 - set by default; • cp1251 - Attention! This charset will be incorrectly recognized by Microsoft Excel app!
Show notifications	
Display notification when	<p>Allows to enable notifications for the following message types:</p> <ul style="list-style-type: none"> • transaction errors (set by default)- transaction error messages - see section 6.7.3; • administrator's messages (set by default)- see section 6.7.1; • other errors and warnings - other error messages (see section 6.7.2) and some warnings. <p>To enable the notification option, check the appropriate checkbox.</p>
Notification floodcontrol	<p>If the option is enabled (by default), then the number of notifications displayed in the tray will be limited. In this case, the aggregated message will be displayed in the tray no more often than specified in Accumulation timeout field.</p> <p>If the option is disabled, all incoming notifications will be displayed in the tray without any limitations.</p>
Accumulation timeout	<p>The periodicity with which the aggregated message is sent to the tray (in seconds). This message contains information about notifications received during this period.</p>
Connections	
Autoconnect after startup	<p>If the option is enabled (by default), the application will automatically connect to the trading system after startup, with the login and password used in the last connection session. No connection window will appear on the screen.</p>
Reconnect automatically after disconnection	<p>If the option is enabled (by default), the application will automatically reconnect to the trading system in case of any connection failure, with the login and password used in the last connection session. No connection window will appear on the screen.</p>
Maximum connection attempts	<p>The option is available only if the Reconnect automatically after disconnection option has been enabled.</p> <p>If the option is enabled, the application will make the limited number of reconnection attempts, according to the specified value.</p> <p>If the option is disabled (by default), the application will continue making reconnection attempts until connection will be established.</p>

10.2. Setting the terminal appearance

The **View** tab of the **Main (Settings/ Terminal settings)** section contains the options for the terminal appearance and its feedbacks to the user actions.

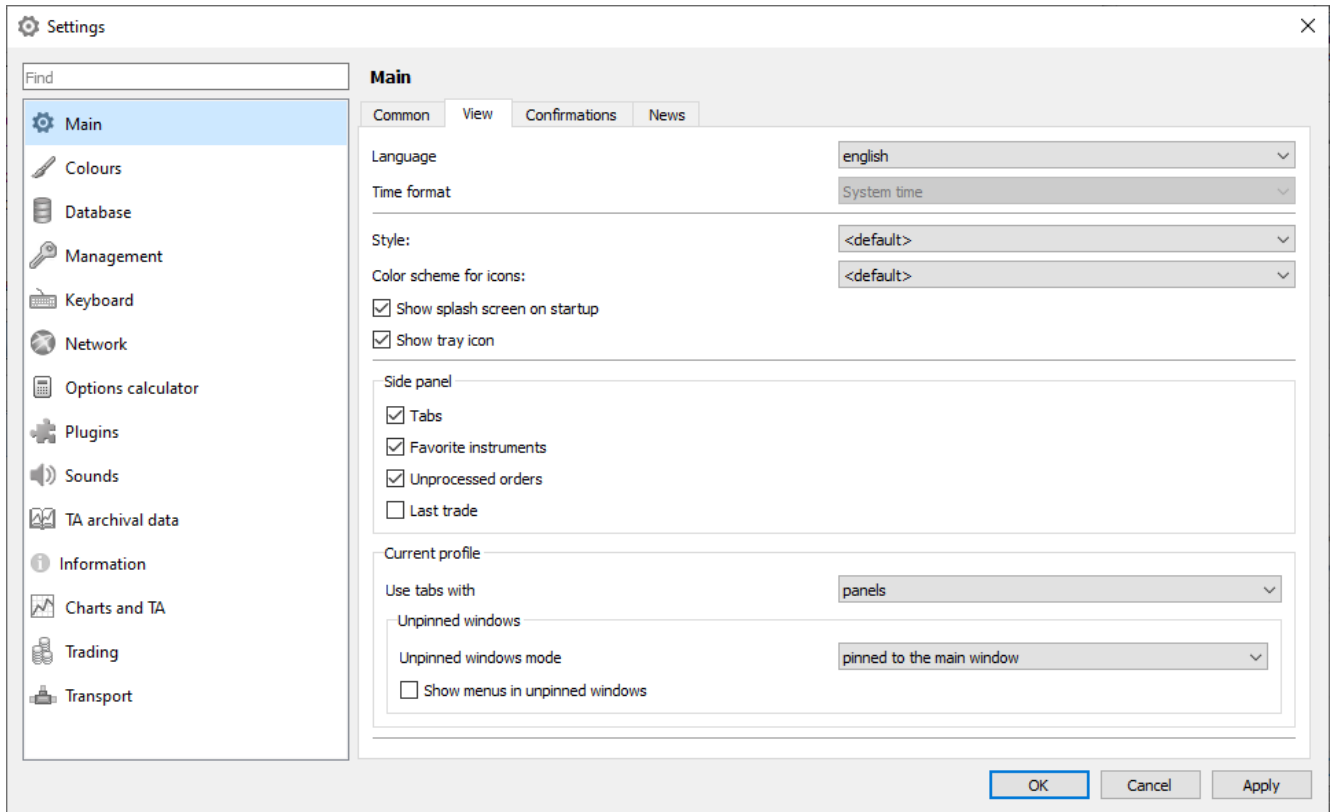

Fig. 10.4. Settings. The Main/ View tab.

Tab. 10.2. Parameters of the View tab

Parameter	Details
Language	<p>Allows to set language of the application user interface:</p> <ul style="list-style-type: none"> • Russian; • English; • system - OS language (by default). <p>The changes will be applied after restart of the application.</p>
Time format	<p>OS system time (by default). Displayed as a parameter in all the application windows.</p> <p>This field is non-editable.</p>
Style	<p>The application appearance style, can be selected in the drop-down list. By default, the current OS style is used.</p>
Color scheme for icons	<p>Color scheme for the application icons in the drop-down list:</p> <ul style="list-style-type: none"> • grey-blue (default); • green; • red.
Show splash screen on startup	<p>If the option is enabled (by default), the application splash screen will be displayed at the application start.</p>
Show tray icon	<p>If the option is enabled (by default), the terminal icon will be displayed in the system tray.</p>

Parameter	Details
Side panel	These options allows to specify the sections on the side panel. To select a section to be displayed in the side panel, you should check the appropriate checkbox next to each section name.
Tabs	If the option is enabled (by default), the side panel will contain the Tabs section. This setting affects all the application windows.
Favorite instruments	If the option is enabled (by default), the side panel will contain the Favorite instruments section. This setting affects all the application windows.
Unprocessed orders	If the option is enabled (by default), the side panel will contain the Unprocessed orders section. This setting affects all the application windows.
Last trade	If the option is enabled (by default), the side panel will contain the Last trade section. This setting affects all the application windows.
Current profile	
Use tabs with	<p>Tabs settings for the application windows. There are two tabs types are available:</p> <ul style="list-style-type: none"> • windows; • panels (by default). <p>Every new tab will be created as panel by default. After switching the tab type, all open tabs will automatically change their types.</p> <p>This setting affects the current workspace configuration only.</p>
Unpinned windows mode	<p>Unpinned windows can be displayed in the following ways:</p> <ul style="list-style-type: none"> • pinned to the main window (by default) - the unpinned window always overlays the main window. When you maximize/minimize the main window, the unpinned window will also maximize or minimize. • independent windows - this window has its own icon in the task panel. It can be overlaid by other windows.
Show menus in unpinned windows	<p>If this option set, then, unpinned windows will contain the application main menu (as the application main window does).</p> <p>If the option is not set (by default), unpinned windows will not contain the main menu line.</p>

10.3. Confirmations settings

You can enable and disable confirmations on some actions using the **Confirmations** tab (**Settings/ Terminal settings/ Main**).

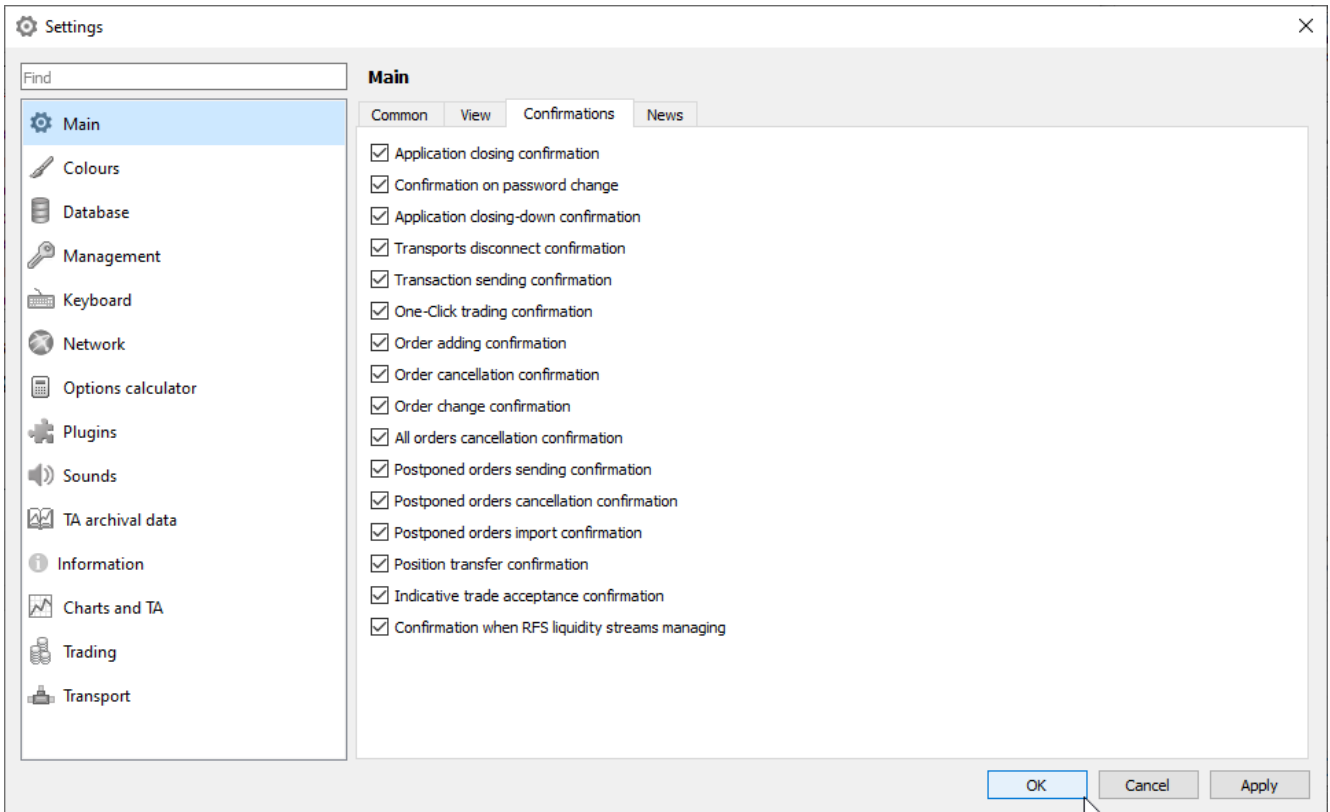

Fig. 10.5. Confirmations settings

Tab. 10.3. Confirmations

Parameter	Details
Application exit confirmation	<p>If the option is enabled, you will receive the confirmation dialog: 'Are you sure you want to exit?' every time you exit the application. Answer:</p> <ul style="list-style-type: none"> • Yes– to exit the application; • No – to return back to the application main window. <p>You can disable the confirmation dialog by checking the Do not show this dialog next time checkbox. After that, no confirmation dialog will be shown at exit.</p>
Confirmation on password change	<p>If the option is enabled, you will receive the confirmation dialog: 'Are you sure you want to change password?' every time you opt to change your password. Answer:</p> <ul style="list-style-type: none"> • Yes– confirm password change; • No– cancel password change. <p>You can disable the confirmation dialog by checking the Do not show this dialog next time checkbox. After that, no confirmation dialog will be shown at exit.</p>
Application close down confirmation	<p>If the option is enabled, you will receive the confirmation dialog: 'Are you sure you want to exit?' every time you close down the application window. Answer:</p> <ul style="list-style-type: none"> • Yes– to close down the main window;

Parameter	Details
	<ul style="list-style-type: none"> • No – to return back to the application main window. <p>You can disable the confirmation dialog by checking the Do not show next time checkbox. After that, no confirmation dialog will be shown at closing the main window.</p>
Transport disconnect confirmation	<p>If the option is enabled, you will receive the confirmation dialog: «'Are you sure you want to stop the transport SPECTRA?' every time you disconnect from the trading system. Answer:</p> <ul style="list-style-type: none"> • Yes– to disconnect; • No– to remain connected. <p>You can disable the confirmation dialog by checking the Do not show next time checkbox. After that, no confirmation dialog will be shown at disconnecting from the trading system.</p>
Transaction sending confirmation	<p>If the option is enabled, you will receive the confirmation dialog: 'Are you sure you want to send the transaction?'. Answer:</p> <ul style="list-style-type: none"> • Yes– to confirm sending transaction; • No– to abort sending transaction. <p>If the option is disabled, no confirmation dialog will be shown at sending transactions into the trading system.</p>
One-Click trading confirmation	<p>If the option is enabled, you will receive the confirmation dialog: 'Are you sure you want to place buy/sell order at price...?' every time you add an order using the One-Click trading mode. Answer:</p> <ul style="list-style-type: none"> • Yes– to confirm adding order; • No– to abort adding the order. <p>If the option is disabled, no confirmation dialog will be shown at adding orders into the trading system in the One-Click mode.</p>
Order adding confirmation	<p>If the option is enabled, you will receive the confirmation dialog: 'Are you sure you want to place buy/sell order at price...of...contracts from account...?'. Answer:</p> <ul style="list-style-type: none"> • Yes– to confirm sending transaction; • No– to abort sending transaction. <p>If the option is disabled, no confirmation dialog will be shown at adding orders into the trading system.</p>
Order cancellation confirmation	<p>If the option is enabled, you will receive the confirmation dialog : 'Are you sure you want to <i>cancel the order</i>?'. Answer:</p> <ul style="list-style-type: none"> • Yes– to cancel your order in the trading system; • No– to abort cancellation. <p>If the option is disabled, no confirmation dialog will be shown at cancelling your orders in the trading system.</p>
Order change confirmation	<p>If the option is enabled, you will receive the confirmation dialog : 'Are you sure you want to <i>change the buy order from account...number...?</i></p>

Parameter	Details
	<p><i>The new order volume will be less than the specified by the matched part size. You specified quantity ... and the price ... '. Answer:</i></p> <ul style="list-style-type: none"> • Yes– to change your order in the trading system; • No– to cancel change. <p>If the option is disabled, no confirmation dialog will be shown at change your orders in the trading system.</p>
Cancel all orders confirmation	<p>If the option is enabled, you will receive the confirmation dialog : 'Are you sure you want to <i>cancel all orders for instrument...from account...?</i>'. Answer:</p> <ul style="list-style-type: none"> • Yes– to cancel all your orders in the trading system; • No– to abort cancellation. <p>If the option is disabled, no confirmation dialog will be shown at cancelling all your orders in the trading system.</p>
Postponed orders sending confirmation	<p>When the option is enabled, you will receive the confirmation dialog 'Are you sure you want to <i>send ... orders?</i>'. Answer:</p> <ul style="list-style-type: none"> • Yes – to confirm sending pool of orders into the Trading system; • No – to cancel sending. <p>When the option is disabled, the pool of orders will be immediately sent into the Trading system, without asking for any confirmation.</p>
Postponed orders cancellation confirmation	<p>When the option is enabled, you will receive the confirmation dialog 'Are you sure you want to <i>cancel ... orders?</i>'. Answer:</p> <ul style="list-style-type: none"> • Yes – to confirm; the selected postponed orders will be removed from the list; • No – to reject removing postponed orders from the list. <p>When the option is disabled, the selected orders will be removed from the list of postponed orders without asking for any confirmation.</p>
Postponed orders import confirmation	<p>When the option is enabled, you will receive the confirmation dialog 'Are you sure you want to <i>import data? All contents in the current window will be lost?</i>'. Answer:</p> <ul style="list-style-type: none"> • Yes – to confirm – the contents of the window will be placed import data; • No – to reject import - the contents of the window will remain unchanged. <p>When the option is disabled, the data from the text file will be imported without asking for any confirmation.</p>
Position transfer confirmation	<p>If the option is active, you will receive the confirmation dialog: «Are you sure you want to <i>transfer position...for instrument...from account...to account...?</i>». Answer:</p> <ul style="list-style-type: none"> • Yes – to confirm transferring position from one account to another; • No – to cancel the transfer.

Parameter	Details
	If the option is disabled, no confirmation dialog will appear.
Indicative trade acceptance confirmation	<p>When the option is enabled, you will receive the confirmation dialog for indicative trade. Answer:</p> <ul style="list-style-type: none"> • Yes – indicative trade is confirmed, an order from LP will be sent to the system; • No – RFS order process is stopped with appropriate status. <p>When the option is disabled, then the indicative trade is considered approved without the confirmation of the liquidity provider (auto last look).</p>
Confirmation when RFS liquidity streams managing	<p>When the option is enabled, you will receive the confirmation dialog for any operation with liquidity stream. Answer:</p> <ul style="list-style-type: none"> • Yes – to confirm; • No –to reject operation. <p>When the option is disabled, any operation with liquidity stream will be performed without asking for any confirmation.</p>

10.4. News sources settings

You can set up a list of news sources, news from which will be displayed in a **News** window (see section 6.1.4). The setting is made on the **News** tab (**Settings/ Terminal settings/ Main**).

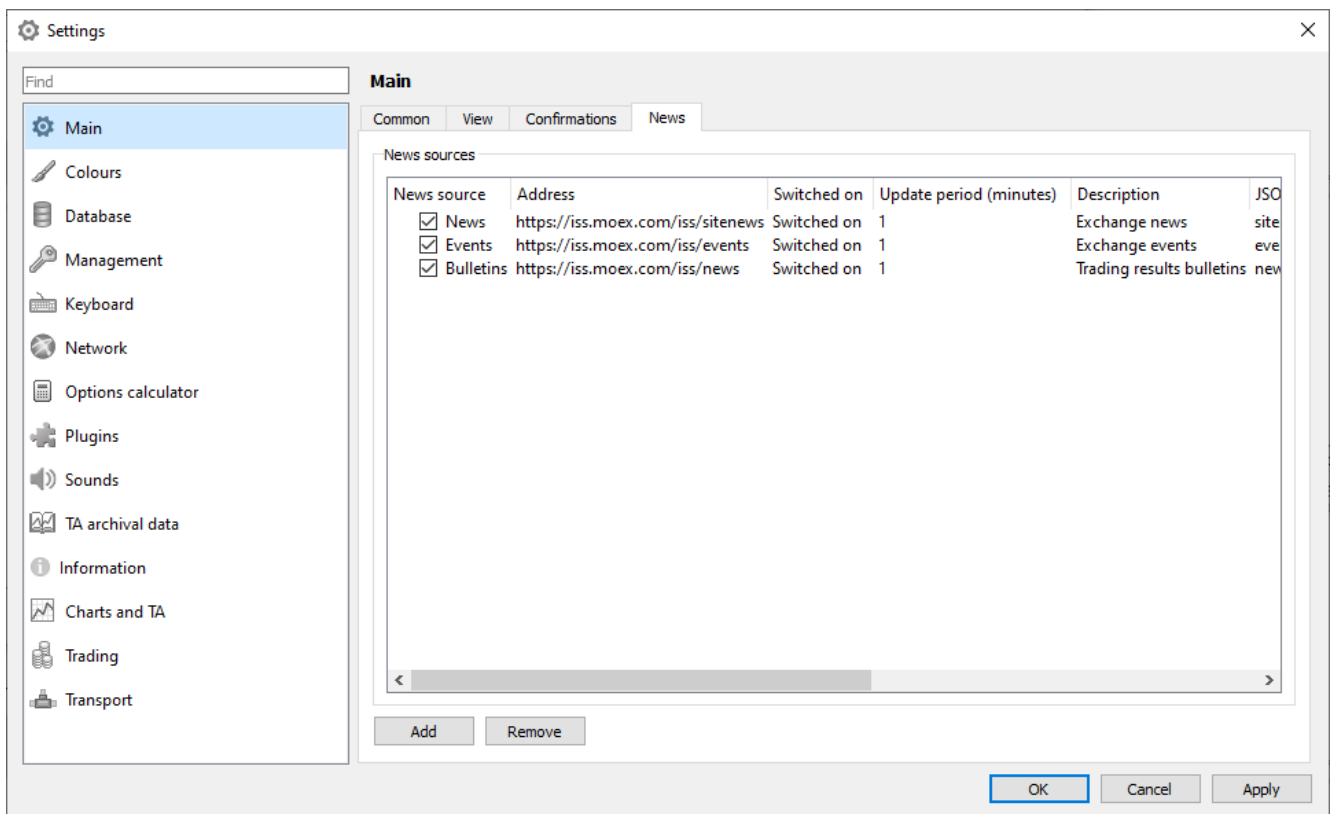

Fig. 10.6. News sources settings

Tab. 10.4. News sources parameters

Parameter	Details
News source	News source short name
Address	Internet resource address on which the news source is based
Switched on	<p>Flag of source activity. The flag is set in the checkbox located to the left of the source's short name by left-clicking the mouse.</p> <p>If the flag is set, then news from this source will be displayed in the News window. The value Switched on will be displayed in the Switched on column.</p> <p>If the flag is not set, then news from this source will not be displayed in the News window. The value Switched off will be displayed in the Switched on column.</p>
Update period (minutes)	The frequency of requesting news from the source in minutes.
Description	The news source description.
JSON data section name in news list	JSON data section name in news list
JSON data section name in detailed description of the news	JSON data section name in detailed description of the news

By default, there are three news sources which cannot be changed or deleted:

- exchange news;
- exchange events;
- trading results bulletins.

For default sources, you can change activity (flag **Switched on/ Switched off**) and **Update period**. The flag is set in the checkbox located to the left of the source's short name by left-clicking the mouse. **Update period** is edited directly in the line, the editing mode is activated by double-clicking the left mouse button in the area of the parameter being edited.

10.5. Colour settings

You can specify colours for the main window elements, as well as the background colors via the **Colours** section (**Settings/ Terminal settings**).

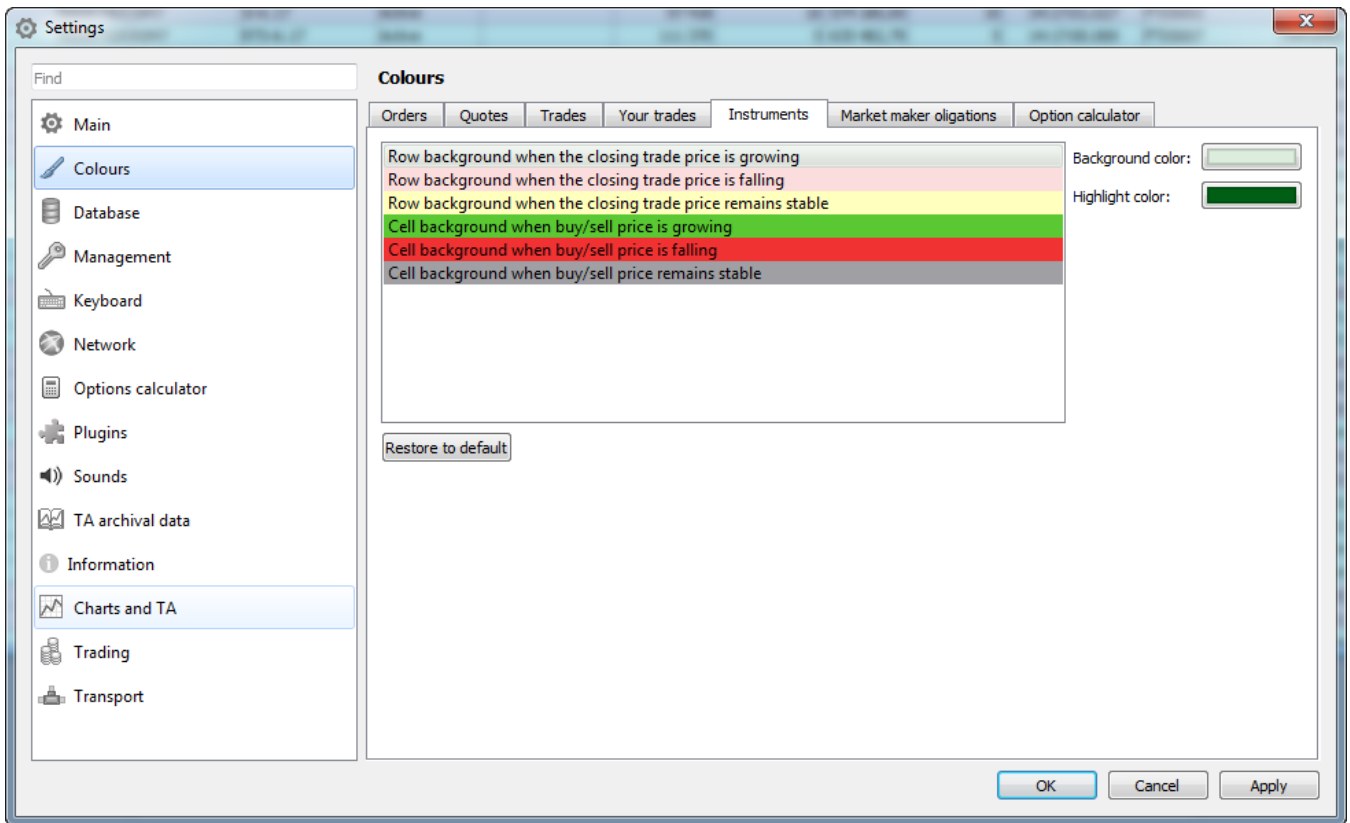

Fig. 10.7. Colours settings

You can specify colours for the trades, orders, financial instruments and RFS windows. For each window, the settings are made via a separate tab of the **Colours** section (see fig. 10.7):

- **Orders** - for the **Your Orders** window;
- **Quotes** - for the **Order-book** window;
- **Trades** - for the **Trades** window;
- **Your trades** - for the **Your trades/ requests** window;
- **Instruments** - for the **Financial Instruments** and **Options board** windows;
- **Options calculator** - for active cells containing virtual values of the virtual portfolio window **Options calculator**;
- **RFS** - for **RFS (active streams)** window.

Changing colour for one window of a group always affects the other windows of the same group.

Every window type has its own parameters, for which the colour highlighting can be set – see tab. 10.5.

You can specify colour for a particular element using the **Background color** and **Highlight color** buttons on the right side of the settings window (see fig. 10.7). The **Background color** button allows to specify the background colour of the element, while the **Highlight color** button specifies colour of the element itself. After pressing one of these buttons, the standard **Select Color** window will appear on the screen.

Please note, that the colour settings you made will be automatically switched to standard settings within the certain time period. This time period is set by default and you cannot change it.

Tab. 10.5. Colour settings

Parameter	Details
	Orders

Parameter	Details
Row background for buy order	Buy order row background colour.
Row background for sell order	Sell order row background colour.
Quotes	
Row background for buy order	Buy order row background colour.
Row background for sell order	Sell order row background colour.
Best buy order cell background	Best buy order cell background colour.
Best sell order cell background	Best sell order cell background colour.
Trades	
Row background with buy-driven trade	Row background colour (buy-driven trade).
Row background with sell-driven trade	Row background colour (sell-driven trade).
Row background when trade direction is undefined	Row background when trade direction is undefined
Your trades	
Row background with buy trade	Row background colour (your buy trade)
Row background with sell trade	Row background colour (your sell trade)
Instruments	
Row background when the closing trade price has grown	Row background colour when the closing trade price has grown.
Row background when the closing trade price has fallen	Row background colour when the closing trade price has fallen.
Row background when the closing trade price remains the same	Row background colour when the closing price remains the same as previous.
Cell background when buy/sell price is growing	Cell background colour when the buy/cell price is growing.
Cell background when demand/offer price is falling	Cell background colour when the buy/cell price is falling.
Cell background when demand/offer price remains stable	Cell background colour when the buy/cell price remains stable.
Market maker obligations (The default colours are: red when unfulfilled and green when fulfilled.)	
Series of options row background colour (obligations are fulfilled)	For the Market maker obligations for options window Highlight colour for series of options parameters record (obligations are fulfilled)
Series of options row background colour (obligations are unfulfilled)	For the Market maker obligations for options window Highlight colour for series of options parameters record (obligations are unfulfilled)
Spread sell background colour (obligations are fulfilled)	The Spread by agreement column cells highlight colour (obligations are fulfilled).
Spread sell background colour (obligations are unfulfilled)	The Spread by agreement column cells highlight colour (obligations are unfulfilled).

Parameter	Details
Quantity sell background colour (obligations are fulfilled)	The Amount by agreement , column cells highlight colour (obligations are fulfilled).
Quantity sell background colour (obligations are unfulfilled)	The Amount by agreement , column cells highlight colour (obligations are unfulfilled).
Fulfilment percentage cell background colour (obligations are fulfilled)	The Min fulfilment (%) , Path fulfilment (%) and Complete fulfilment (%) columns cells highlight colour (obligations are fulfilled).
Fulfilment percentage cell background colour (obligations are unfulfilled)	The Min fulfilment (%) , Path fulfilment (%) and Complete fulfilment (%) columns cells highlight colour (obligations are unfulfilled).
Options calculator	
Active virtual value cell background colour	Background colour for cell containing a virtual value (VIV or VP) which has been changed by user.
RFS - liquidity streams window	
Row background for streams opened from our login	Row background colour for streams, which were opened from our login.
Row background for streams close to expiration	Row background colour for streams, whose lifetime is close to expiration.
Cell background when buy/sell quote is growing	Cell background colour when the buy/sell quote price is growing.
Cell background when demand/offer quote is falling	Cell background colour when the buy/sell quote price is falling.
Cell background when demand/offer quote remains stable	Cell background colour when the buy/sell quote price remains stable.

The **Restore to default** button (see fig. 10.7) allows to restore the default colour settings. This button affects only the windows which colour settings are set in the current tab. In order to restore the default settings for all windows, you should press the **Restore to default** button in every window, one by one.

10.6. Database settings

The **Database** section (**Settings/ Terminal settings**) contains various database settings options.

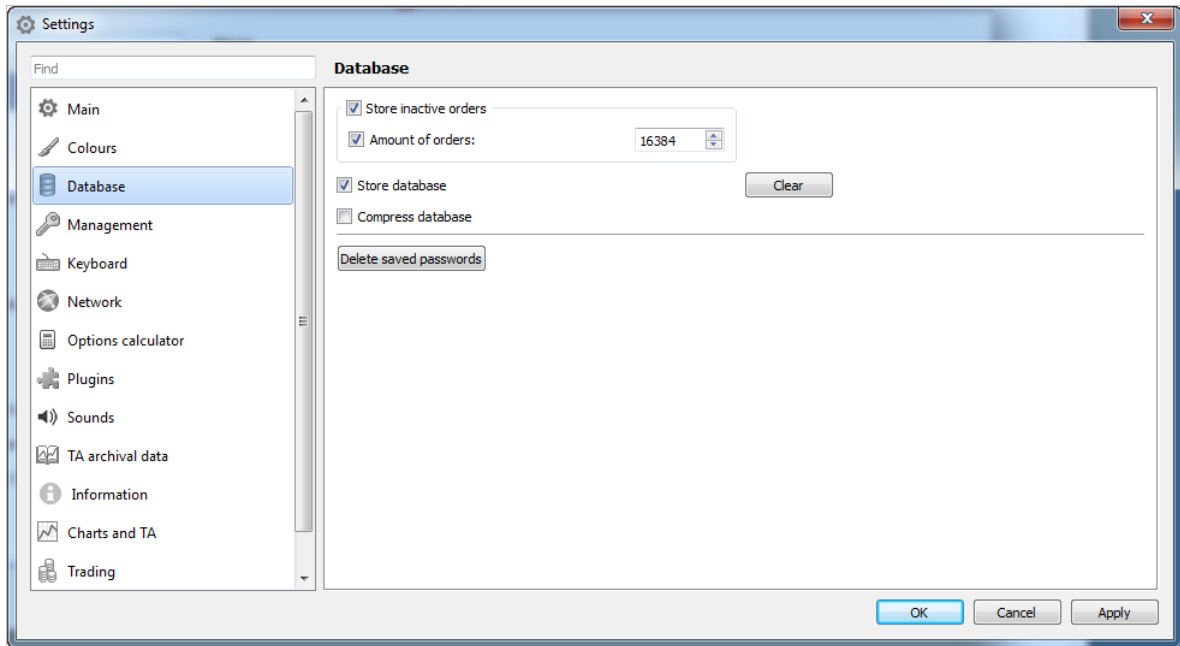

Fig. 10.8. Database settings

Tab. 10.6. Database settings

Parameter	Details
Store inactive orders	If the option is enabled, your inactive orders (outdated, matched, etc) will be stored in the database archive on the hard drive. Otherwise, the inactive orders will not be stored anywhere.
Number of orders	You can vary number of the stored orders using the Number of orders field. If a value set in this field, the most oldest inactive orders will be automatically replaced with newer ones to keep the total number equal to that set in the field.
Save database	If the option is enabled, the database will be saved in hard drive of your local computer. The saving is performed at closing the application.
Compress database	If the option is enabled, the database will be compressed before saving. This option allows to save space in your hard drive. The option is usable only if the Save database option has enabled.
Clear	The option allows to clear the current database (this action WILL NOT affect any the saved database in your hard drive!). Before starting, you will receive the confirmation dialog <i>'Are you sure you want to clear the database? All connections will be stopped. All data in all tables will be permanently deleted!'</i> . Press Yes to confirm or No to cancel. This action is useful when you switch to another profile of going to use another user login, as it deletes some junk files left from the previous users.
Delete saved passwords	Allows to delete saved user passwords (password are saved if the Save password option has been enabled in the registration form (see fig. 10.8)). Before deletion, you will receive the confirmation dialog: <i>'Are you sure you want to delete all saved passwords? This operation cannot be undone.'</i> Press Yes to confirm, or No to cancel.

10.7. Management confirmations settings

The **Management** section (**Settings/ Terminal settings**) contains the settings options for the **Management** plugin. All these operations can be found in the **Management** main menu item. For some of the operations, you can set confirmation messages.

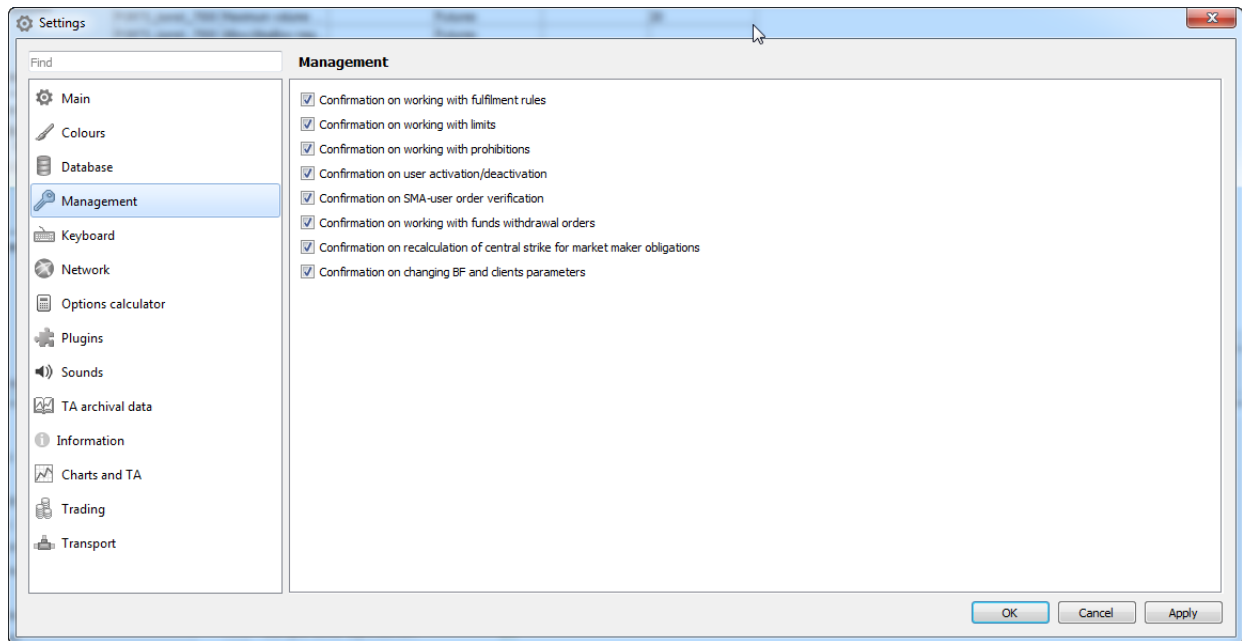

Fig. 10.9. Management settings

You can set the confirmation dialogs for the same operations:

- working with exercising rules;
- working with limits;
- working with prohibitions;
- user activation/deactivation;
- SMA-user order verification;
- working with money withdrawal orders;
- recalculation of central strike for market makers obligations.
- changing BF and clients parameters.

You should the option separately for every operation type.

After the option has been enabled, you will receive a confirmation message every time you perform an operation from the list above.

10.8. Hot keys settings

You can assign hot keys combinations for the most frequently used operations. There are some hot keys combinations already assigned by default, but you can change them manually via the **Settings/ Terminal settings** main menu item of the Keyboard section.

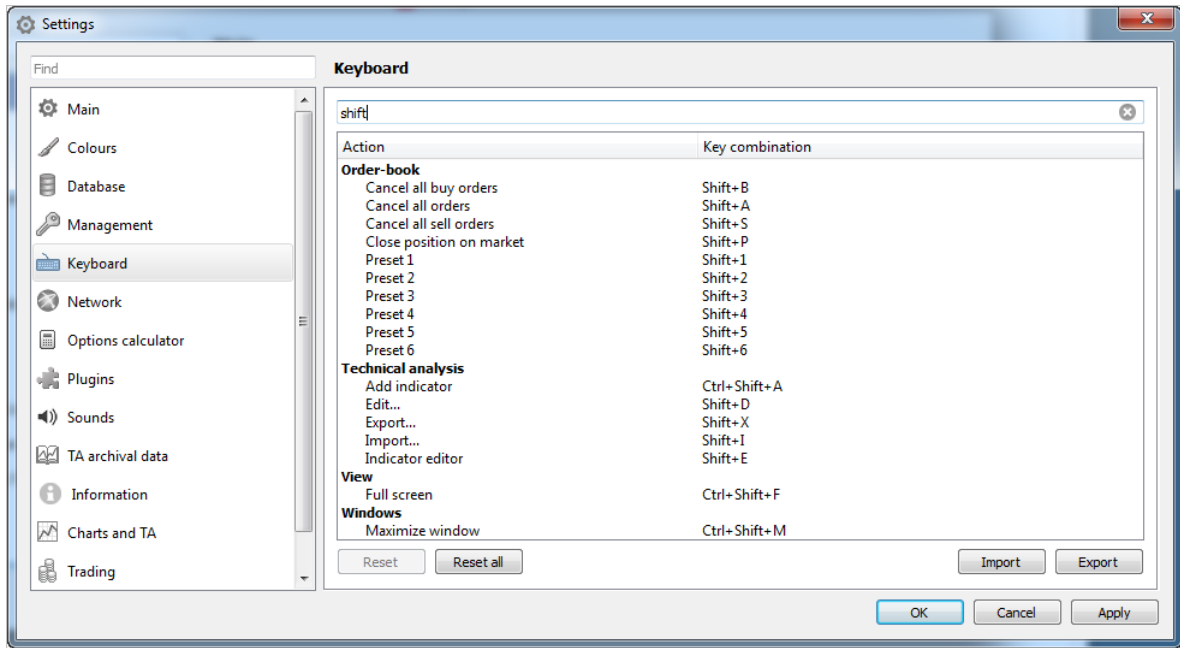

Fig. 10.10. Hot keys settings

Tab. 10.7. Hot keys

Action	Key combination
Exit	Ctrl+Q
Help	
Help	F1
Tables	
Administrator's messages	Ctrl+Alt+M
Main	
Favorite instruments	Ctrl+Alt+F
Plaza2 log file	Ctrl+Alt+L
Terminal settings	Ctrl+,
Option calculator	
Redo	Ctrl+Y
Undo	Ctrl+Z
Order-book	
Best buy	B
Best buy for the current position	T
Best sell	S
Best sell for the current position	Y
Buy at the best price	G
Buy at the best price for current position amount	J
Cancel all buy orders	Shift+B
Cancel all sell orders	Shift+S
Center	Ctrl+R
Close position on market	Shift+P

Action	Key combination
Preset 1	Shift+1
Preset 2	Shift+2
Preset 3	Shift+3
Preset 4	Shift+4
Preset 5	Shift+5
Preset 6	Shift+6
Sell at the best price for current position amount	K
Sell at the best price	F
Cancel all orders	Shift+A
Technical analysis	
Add chart	Ctrl+A
Add indicator	Ctrl+Shift+A
Autoscale by entire series	Ctrl+D
Autoscale by screen	Ctrl+F
Edit	Shift+D
Export	Shift+X
Import	Shift+I
Indicator editor	Shift+E
Object manager	Ctrl+J
Rebuild	Ctrl+R
Reset time axis	Ctrl+0
Scale down the time axis	Ctrl+-
Scale up the time axis	Ctrl+=
Select instrument	Alt+C
Show chart hint	Ctrl+U
Show grid	Ctrl+G
Show projections on axis	Ctrl+P
Undo scaling on the time axis	Ctrl+Backspace
View	
Full screen	Ctrl+Shift+F
Information	Ctrl+I
Show side panel	Ctrl+L
Windows	
New tab	Ctrl+T
New window	Ctrl+N
Pin/ unpin window	Alt+W
Save configuration	Ctrl+S
Window settings	Ctrl+E

For some actions, the **Key combination** field is empty (fig. 10.10). This means, that you should assign a hot key combination manually.

The **Contextual actions** group contains the context-related actions, i.e. the actions, which provide different results being performed in different windows.

To set a new hot key combination (or edit an existing) you should make the following steps:

- place the mouse cursor on a line containing the operation you want to change the hot key combination for (see fig. 10.10);
- double-click the line with the left mouse button; the line background colour will then change to white;
- press the hot key combination you want to assign. Please note, that you can assign a combination by pressing several keys simultaneously;
- press **Apply** or **OK**.

The default combinations are displayed in standard font. The user assigned combinations are marked with **bold** (or *italic*, before they are saved).

Sometimes it may be convenient to assign the same key combination to different actions. Such combinations, if assigned, are marked in red.

The **Reset** button allows to reset any user assigned key combination to its default value. The **Reset** button becomes active when you put the mouse cursor on a line containing the operation name. Please note, that you cannot 'reset' the default key combinations.

The **Reset all** button allows to reset all user assigned key combinations to default at once.

When a line is in the edit mode, the special button (white cross on a red field) appears in the right, which allows to delete the default key combination. Pressing the **Reset** button, you can restore the default key combination.

You can search for a key combination by typing symbols into the contextual search field; the case-insensitive search starts immediately after entering the first symbol. The search results will display all records containing the entered symbols. To clear search results simply delete symbols from the search field.

The keyboard settings can be exported into a file and imported from a file by using the following buttons:

- **Import** – to import keyboard settings from a **.kms** file (keyboard layout scheme);
- **Export** – to export keyboard settings into a **.kms** file (keyboard layout scheme);

10.9. Network settings

The **Network** section (**Settings/ Terminal settings**) contains the network and proxy-server settings options.

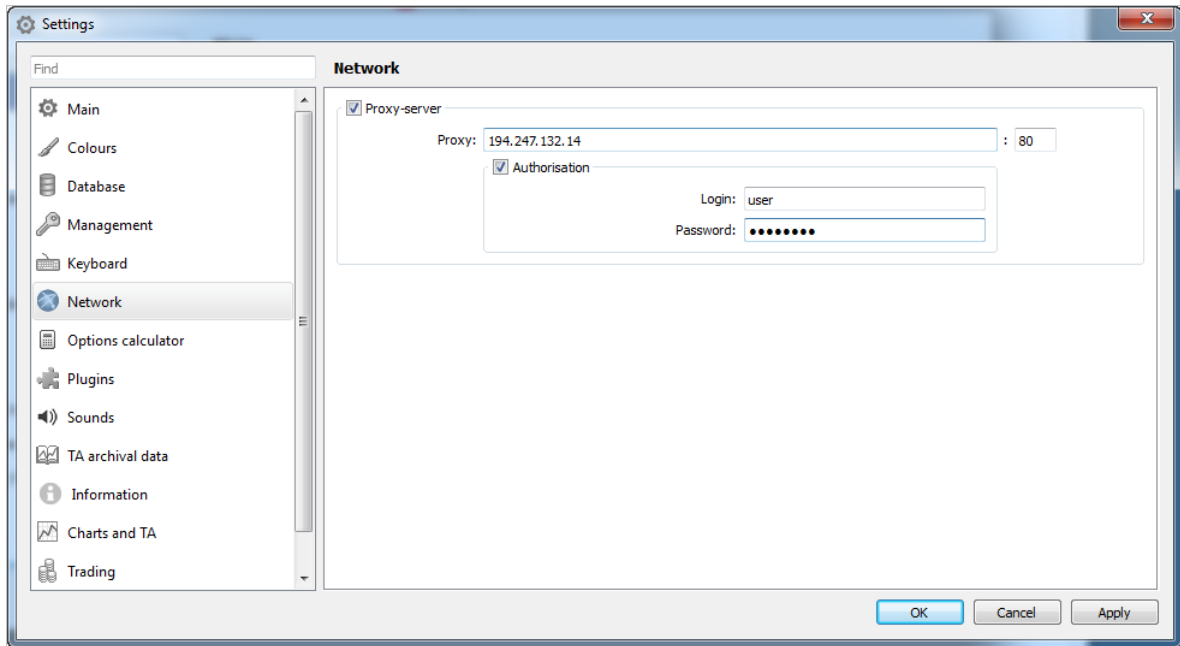

Fig. 10.11. Proxy-server settings

The **Proxy-server** option defines whether a proxy-server is used (the option is enabled) in the network connection or not (the option is disabled).

The proxy-server settings require its network address and the port number to be set. Also, user login and password can be specified for the proxy-server, if needed.

10.10. Confirmations settings in the option calculator

You can set confirmation dialogs for the option calculator module via the **Option calculator** section (**Settings/ Terminal settings**).

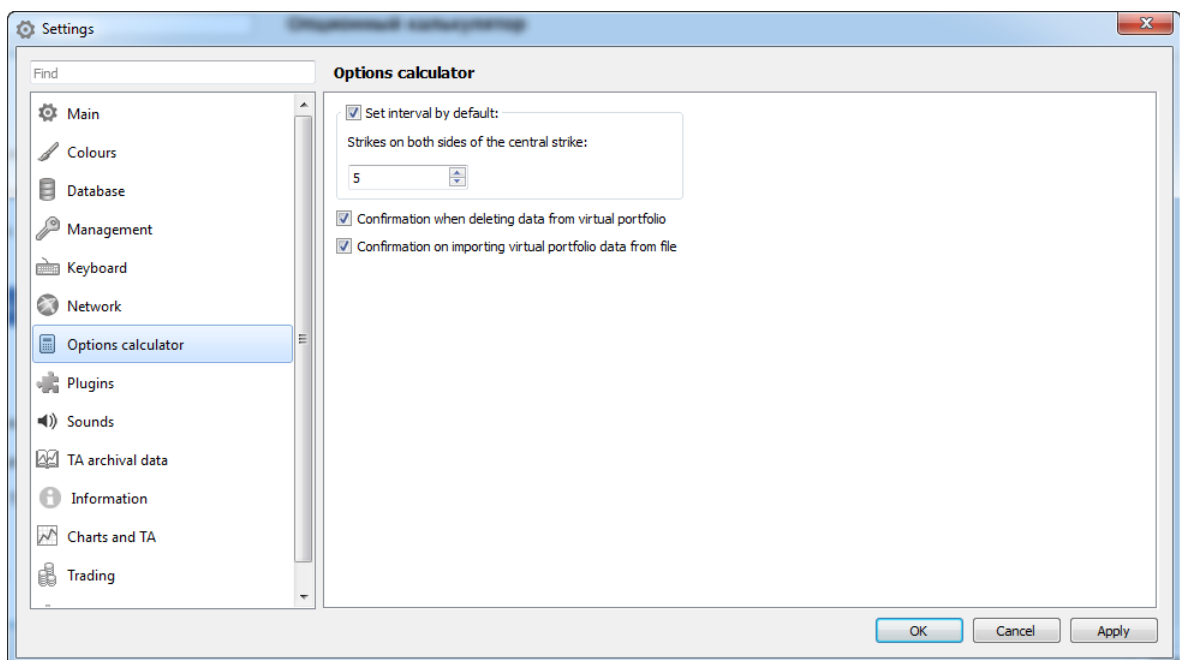

Fig. 10.12. Confirmations settings for the option calculator module

Tab. 10.8. Confirmations in the option calculator

Parameter	Details
Set interval by default	<p>If the option is enabled, the X-axis scale will be calculated according to the number of strikes on the both sides of the central strike.</p> <p>You can specify number of strikes in the field Strikes on both sides of the central strike.</p>
Confirmation when deleting data from virtual portfolio	<p>If the option is enabled, you will receive the confirmation dialog: <i>'Are you sure you want to delete all data of virtual portfolio?'</i> every time you clean virtual portfolio. Answer:</p> <ul style="list-style-type: none"> • Yes– to clean virtual portfolio; • No – the contents of the window will remain the same. <p>You can disable the confirmation dialog by checking the Do not show next time checkbox. After that, no confirmation dialog will be shown at closing the main window.</p>
Confirmation on importing virtual portfolio data from file	<p>If the option is enabled, you will receive the confirmation dialog: <i>«'Are you sure you want to import data? All previous data in virtual portfolio will be lost'</i> every time you import data into virtual portfolio from the file. Answer:</p> <ul style="list-style-type: none"> • Yes– to import data from the file; • No– to cancel import. <p>You can disable the confirmation dialog by checking the Do not show next time checkbox. After that, no confirmation dialog will be shown at disconnecting from the trading system.</p>

10.11. Plugins settings

Some functions of the trading terminal have been developed as separate plugins, which may (or may not) be included into the basic configuration. Some of the plugins can start automatically, when needed.

You can specify the plugins connection settings via the **Plugins** section (**Settings/ Terminal settings**).

To connect a plugin, you should check the appropriate checkbox next to the plugin name. To disconnect a plugin, uncheck the appropriate checkbox.

The **Database** and **Main windows** plugins are required for the terminal functioning, therefore you cannot disconnect them.

After you changed the plugins connections settings, you will have to restart the application to apply the changes.

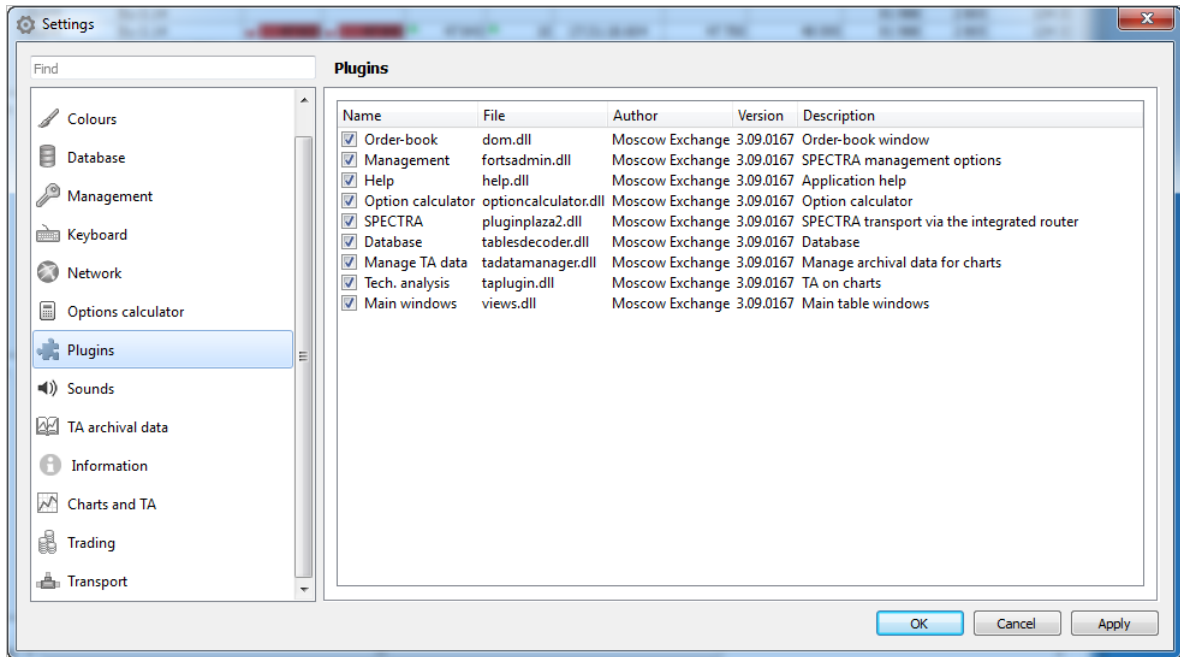

Fig. 10.13. Plugins settings

Tab. 10.9. Plugins

Plugin's name	Description
Order-book	Order-book window.
Management	Management options.
Help	Application help.
Option calculator	Option calculator.
SPECTRA	SPECTRA transport via the integrated router.
Database	Database. Settings for this plugin run under Database (main menu Settings/ Terminal settings) .
Tech. analysis	TA on charts.
Manage TA data	Managing archival data for charts. The plugin allows to import and export data for the Tech. analysis -system. The plugin is not linked with the Tech. analysis plugin . You are allowed to import and export data even having the Tech. analysis plugin disconnected.
Main windows	Main table windows.

10.12. Sounds settings

You can specify sound warnings for different events. To do this, you should use the **Settings/ Terminal settings** main menu item of the **Sounds** section.

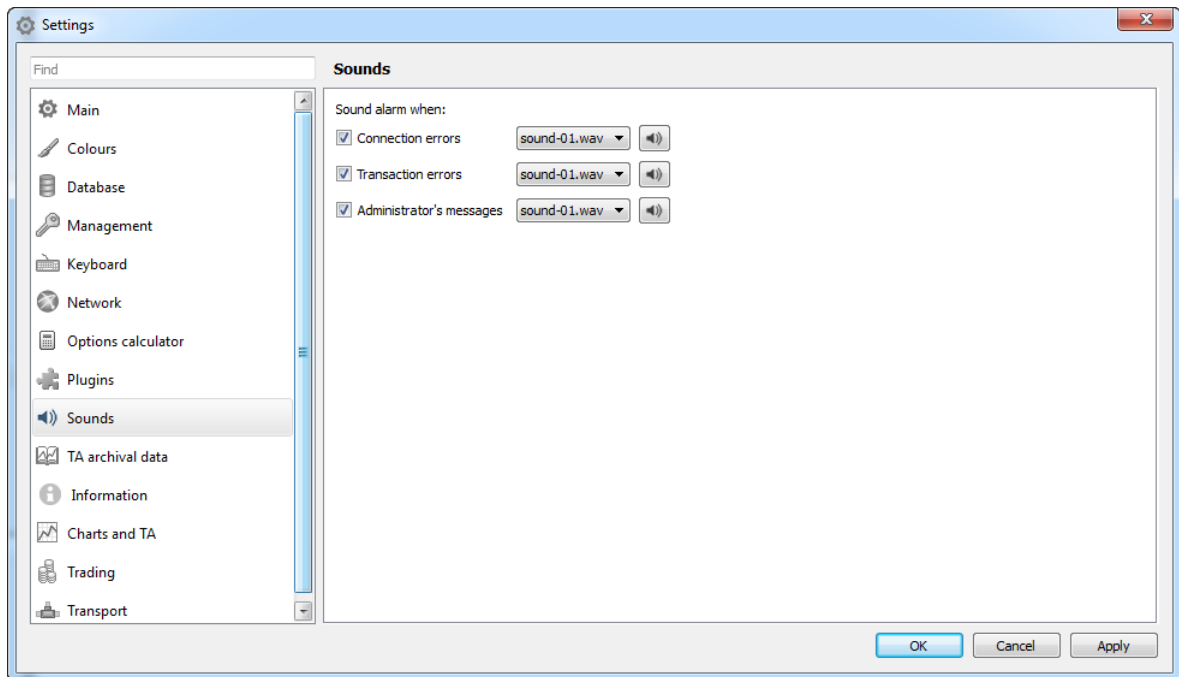

Fig. 10.14. Sounds settings

You can set sound warnings for the following events:

- **Connection errors** - you will be warned with sound in case of any server connection error, any other connection loss, etc.;
- **Transaction errors** - you will be warned with sound in case of any transaction sending error;
- **Administrator's messages** - you will be warned with sound once you receive a message from administrator.

A sound signal for each event can be selected in the appropriate drop-down list. To preview a sound signal, press the button with speaker next to the signal name.

The settings you made will remain unchanged even after restarting the terminal application.

10.13. TA archival data

For technical analysis historical data (see section 9.10), you can specify a period of time for storing the history files via the **Settings/ Terminal settings** main menu item of the **TA archival data** tab.

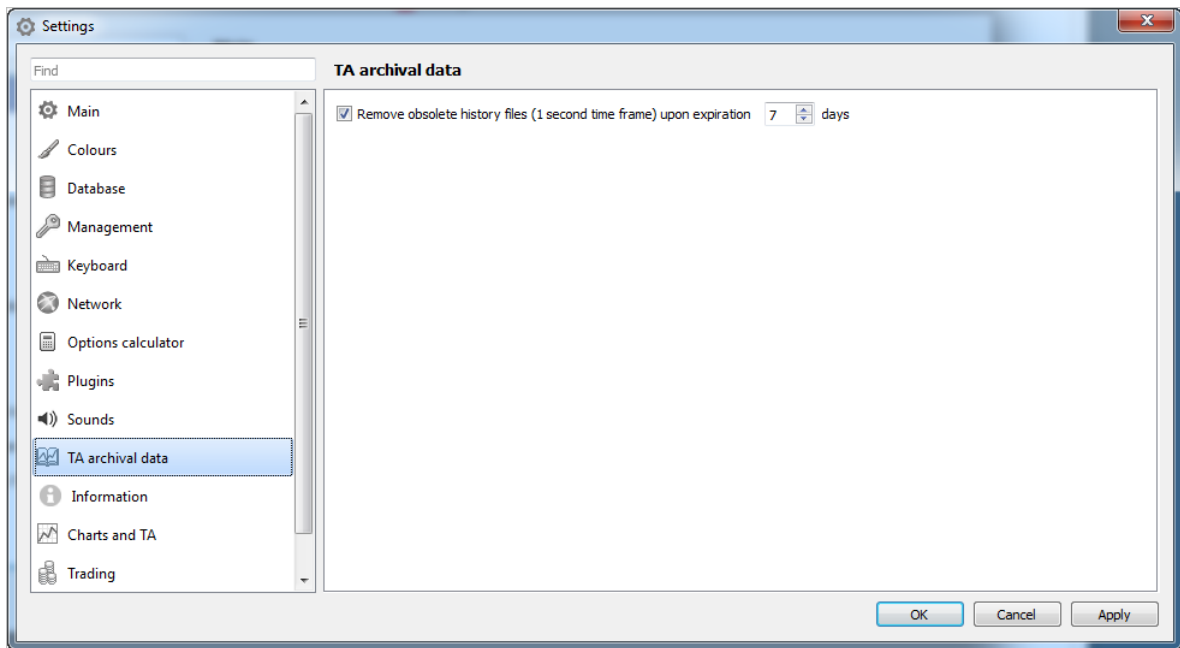

Fig. 10.15. TA archival data settings

The **Remove obsolete history files (1 second time frame) upon expiration ... days** option allows to specify the period of time (in days) for storing the obsolete history files (1 second time frame). The older archives will be deleted. The option is enabled by default.

If the option is disabled, all archive files with the 1 second time frame will be stored.

Please note, that this option does not affect the one minute time frame history files!

10.14. Information window settings

For the **Information** window (see section 6.1.1), you can specify a general set of parameters to be displayed in every **Information** window (except those having some special settings for a particular trading board). The general settings can be performed via the **Settings/ Terminal settings/ Information** main menu item.

To specify settings for a particular trading board, you should use the **Window settings** context menu item opened in the **Information** window (the trading board, therefore, will be the same as that of the instrument the **Information** window has been opened for). After the settings have been specified, they will affect any **Information** window for the instrument, overriding the settings specified via the main menu. For example: you opened the **Information** window for a futures and specified some settings via the **Window settings** context menu item. After that, any **Information** window for futures will have these settings. All other information windows for the instruments of another boards will have the settings specified via the **Settings/ Terminal settings/ Information** main menu item.

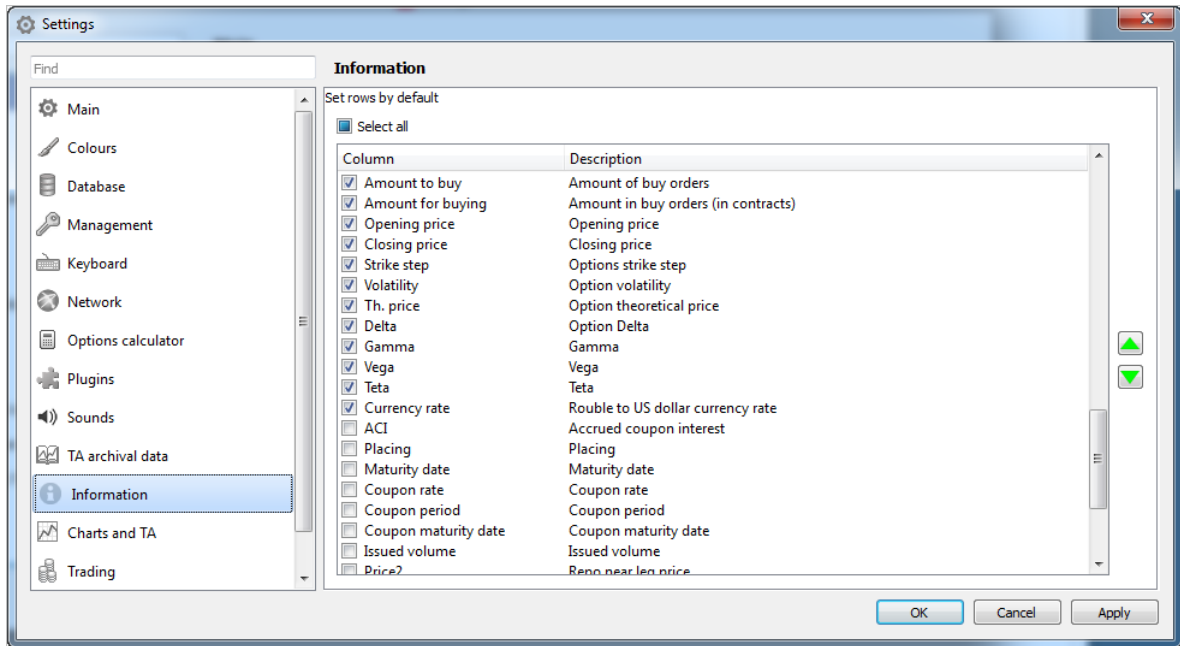

Fig. 10.16. Information settings

10.15. Graphical charts settings

For all newly added graphical charts, the settings can be specified via the **Settings/ Terminal settings** main menu item in the **Charts and TA** tab. Also, the graphical charts settings window can be opened by pressing the **Ctrl+**, key combination. The settings specified this way will be used as the default settings for every newly opened **Tech. analysis** window (for more information see section 9.9).

10.16. Average position price settings

For data calculation in the position indicator (see section 6.2.2.7.1), you can set the average position price source in the **Order-book** window (see section 6.2.2.7.3).

The setting can be specified via the **Settings/ Terminal settings** main menu item in the **Trading** tab.

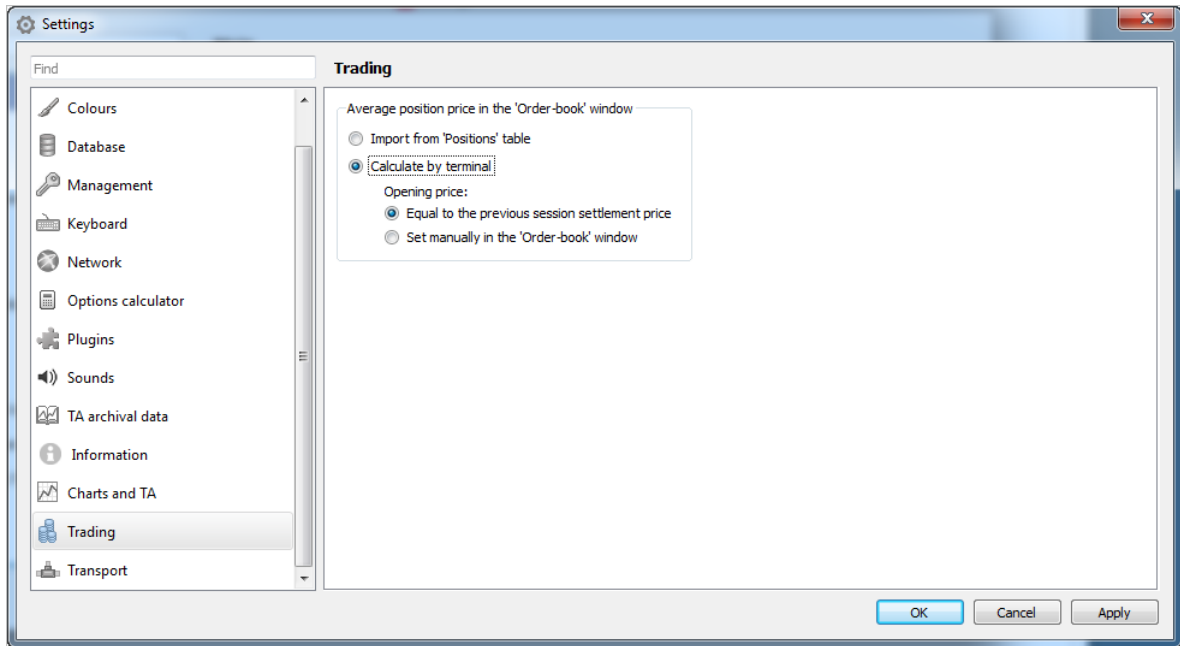

Fig. 10.17. Average position price setting

The average price can be obtained from several sources:

- **Import from 'Positions' table** - the average price will be obtained from the **Positions** table;
- **Calculate by terminal** - the average price will be calculated by the terminal application. This can be made in two ways:
 - **Equal to the previous session settle price** - the opening price will be set equal to the previous session settlement price;
 - **Set manually in the 'Order-book' window** - the opening price will be obtained from the **Opening price** field (see fig. 6.30) in the window settings section (a context menu item in the **Window settings/ Trading** window).

10.17. Transport settings

The transport (aka communication protocol) settings can be specified via the **Settings/ Terminal settings** main menu item of the **Transport** section.

Main settings are set in **Plaza2** tab.

Parameters of connection to ISS server are set in **ISS service** tab - see section 10.17.2.

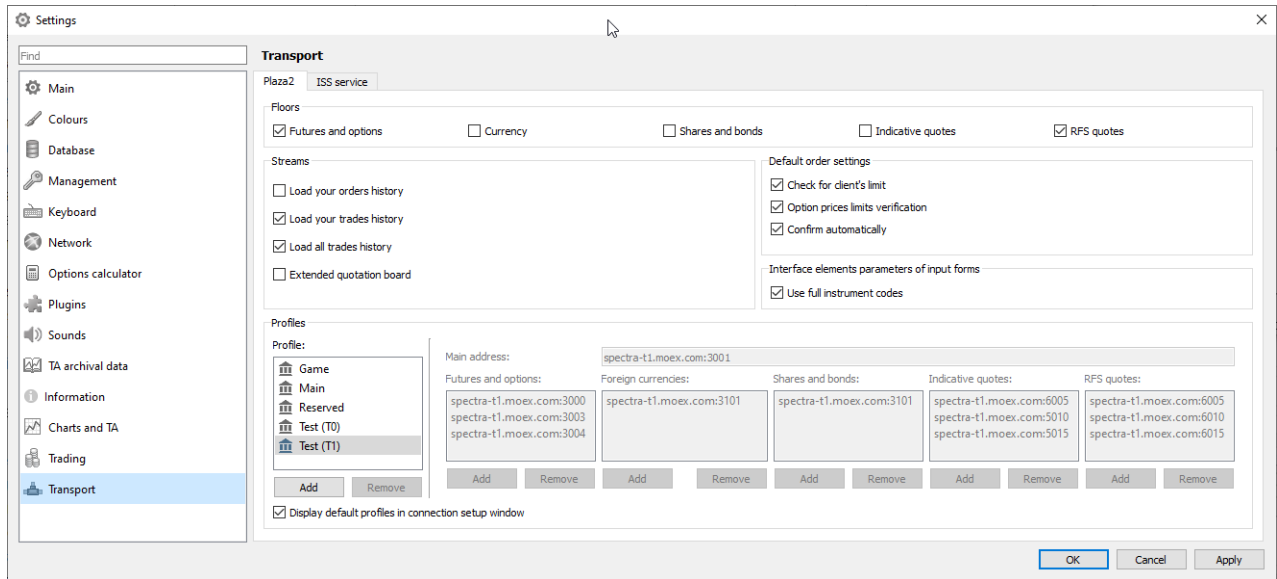

Fig. 10.18. Transport settings

The **Streams** section menu items allows to specify some special settings: amount of data to load and Order-book depth.

Tab. 10.10. Parameters in the Settings/ Transport/ Plaza2 tab

Parameter	Details
Floors	<p>Floors to connect:</p> <ul style="list-style-type: none"> • Shares and bonds; • Currency; • Futures and options; • Indicative quotes - IQS; • RFS quotes - liquidity streams.
Streams	
Load your orders history	<p>When the option is enabled (by default), the Your orders/ requests window will display complete history of your orders (active and inactive (removed and canceled) for the current trading session (the evening session + the period of time passed since start of the current session). In case of a big amount of data, loading may take time, therefore, it is not recommended to enable this option in the end of a trading session. Also, it is not recommended to enable this option working under a BF login or when your connection to the trading system takes much time.</p> <p>When the option is disabled, the Your orders/ requests window will display only your active orders. To delete your inactive orders you should enable the Amount of orders option (the Store inactive orders option in the main Settings/ Terminal settings/ Database menu should be enabled, too) – the orders will be deleted when the specified amount is reached.</p> <p>If the option is disabled, the Your orders/ requests table will not display your partly-matched orders, exercised orders and the orders canceled before the connection has been established.</p>

Parameter	Details
Load your trades history	<p>When the option is enabled (by default), the Your trades/ requests window will display complete history of your trades for the current trading session (the evening session + the period of time passed since start of the current session).</p> <p>If the option is not enabled, the Your trades/ requests window will display only your trades which were performed since establishing the connection to the trading system.</p> <p>The trades history is used for creating graphical charts. Therefore, if the option is disabled, you will not be able to create graphical charts for the time before the connection to the trading system was established.</p>
Load all trades history	<p>When the option is enabled (by default), the All trades/ requests window will display complete history of all trades for the current trading session (the evening session + the period of time passed since start of the current session).</p> <p>If the option is not enabled, the All trades/ requests window will display only the trades which were performed since establishing the connection to the trading system.</p> <p>The trades history is used for creating graphical charts. Therefore, if the option is disabled, you will not be able to create graphical charts for the time before the connection to the trading system was established.</p>
Extended Order-book	<p>If the option is enabled, the Order-book will display 50 records in each direction instead of 20. This option is useful when the sparse mode has been enabled for the Order-book window or for some high liquid instruments.</p>
Default order settings	
Check for client limit	<p>When the option is enabled (by default), all option orders will be verified for client limit sufficiency before being added into the system.</p> <p>If the option is disabled, no verification will be made for the option orders. Please note, that adding of orders without preliminary verification is allowed only for BF granted with the special rights by the administrator.</p>
Option prices limits verification	<p>When the option is enabled (by default), all option orders will be verified for limits sufficiency before being added into the system.</p> <p>If the option is disabled, no verification will be made for the option orders. Please note, that adding of orders without preliminary verification is allowed only for BF granted with the special rights by the administrator.</p>
Confirm automatically	<p>The option applies to providers quotes in liquidity streams (RFS) only.</p> <p>If the option is enabled (by default), all RFS quotes will have an auto-confirmation flag by default.</p> <p>If the option is disabled, all RFS quotes will not have an auto-confirmation flag.</p>
Interface elements parameters of input forms	
Use full instruments codes	<p>If the option is set (by default), then the instruments codes in the combo boxes will be full codes.</p> <p>If the option is not set, then the instruments codes in the combo boxes will be short codes.</p>
Profiles - see section 10.17.1	

10.17.1. Connection profiles

You can create several connection profiles for a single transport. To manage the profiles, please use the appropriate section of the settings window - see fig. 10.19 (the **Settings/ Terminal settings** main menu item, the **Transport** section, **Plaza2** tab).

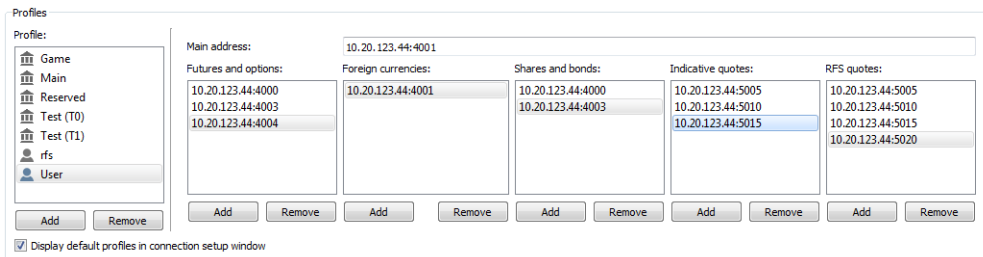



Fig. 10.19. Connection profiles

The **Profile** field contains the editable list of created connection profiles. Please note, that if there is a transport connected, you are not able to edit the profiles – the window will show the details of the current profile, having all other options disabled.

There are two types of profile:

-  - default profiles;
-  - user profiles (i.e. set by users).



Profile **Main** contains settings for the current trading servers. All settings belonging to the previously used servers are stored in the profile **Reserved**.

To add a new profile press the **Add** button right under the list called **Profile**.

For every created profile, you should specify the server address and port number. The **Main address** field contains the main (and, possibly, the only) server IP-address.

For some profiles, you can specify some additional server addresses in the additional addresses field, when needed (when the data stream is processed concurrently by several servers). There is a dedicated list of servers for each trading board: **Futures and options**, **Foreign currencies**, **Shares and bonds**, **Indicative quotes**, **RFS quotes**. To edit the list of additional servers please use the **Add** and **Remove** buttons below the every list.

To delete a profile, press the **Remove** button right under the list called **Profile**.

Option **Display default profiles in connection setup window** allows to hide default profiles in the list of profiles during signing up of a new user (see section 4.3). The option is on by default, and the drop-down list contains all available profiles (field **Profile**). When the option is off, all default profiles (icon ) will be hidden in the user sign up dialog, and only user profiles (icon ) will be displayed.

10.17.2. Loading data from ISS

To manage the data loading parameters please use the **Settings/ Terminal settings/ Transport** main menu item in the **ISS service** tab.

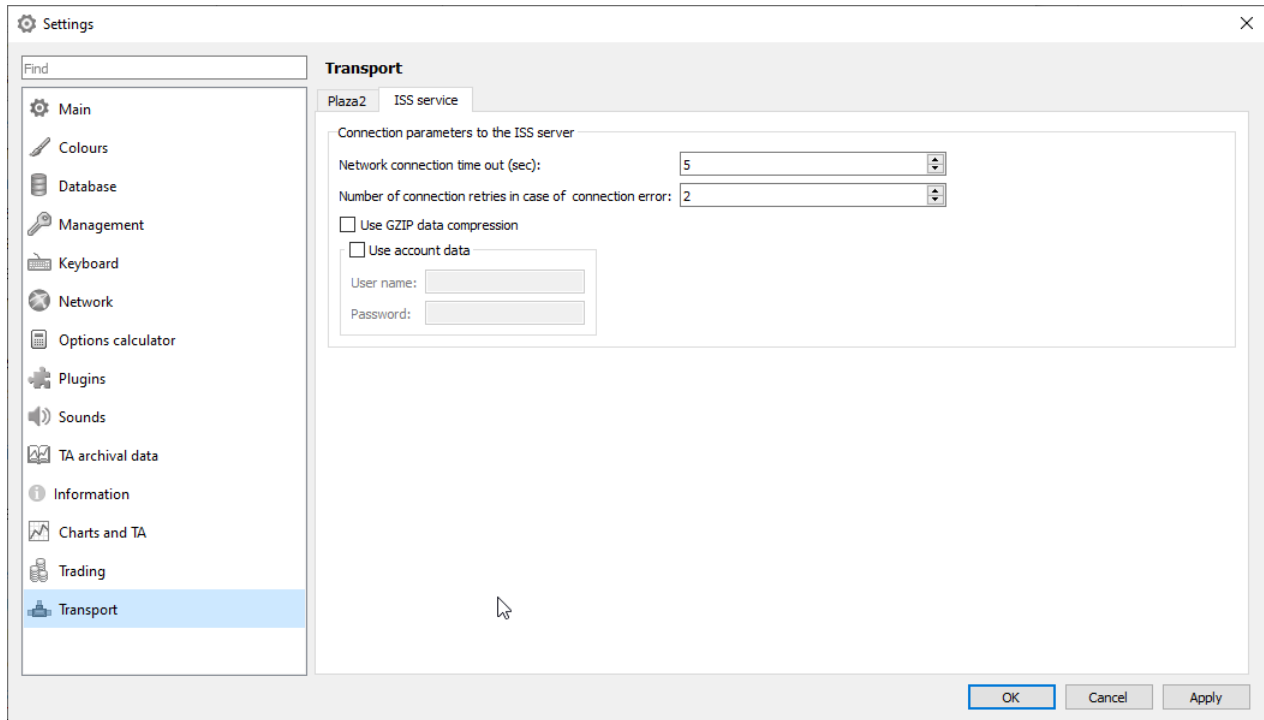

Fig. 10.20. Data load settings

Tab. 10.11. Connection parameters to the ISS server

Parameter	Details
Network connection time out (sec)	Time (in seconds) between reconnection attempts.
Number of connection retries in case of connection error	Number of reconnection attempts.
Use GZIP data compression	The option allows to use a data compression method in order to reduce loading time.
Use account data	If the option is set, you can specify User name and Password for authorized access to the ISS server. By default, the option is not set - in this case, anonymous access to the ISS server without authorization.

10.18. Saving settings

You can save the current settings of a functional window (its size, location, all appearance settings, filter and sorting settings) by using the **Current window/ Save by default** main menu item. Once you performed the action, all new windows of that type will be opened having the configuration you had saved. For the **Tech. analysis** window, the grid settings, data stamp location and main colors will be saved.

To switch to the default window settings, please use the **Current window/ Restore to default** main menu item.

To save the whole workspace configuration, you should use the **File/ Save configuration (Ctrl+S)** main menu item; after this, all currently opened windows, their tabs and their locations will be saved. For more details please see section 5.7.

To switch to the default workspace configuration settings, please use the **File/ Restore configuration**.

10.19. Writing log-files

Every action and event related to the terminal application is logged into the **message.log** file stored in the hard drive; you can find the path to this file using the **Help/ About** main menu item - fig. 10.21.

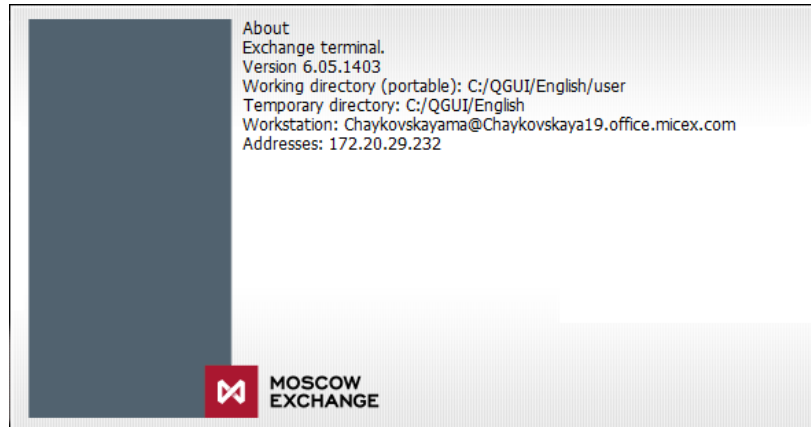

Fig. 10.21. The About window

The **message.log** file is stored in the user's temporary files folder.

Apart from **message.log**, the Plaza2 router log-file is also created, which contain logs for connection and workflow events. The file is saved under the name **P2Trace.20131009.log**, where *20131009* - date of file creation in the *YYYYM-MDD* format.

You can open the log-files using the **Help** main menu item options:

- **Open log file** - opens the trading terminal log-file;
- **Plaza2 log file** - opens the Plaza2 log-file (can be also opened with **Ctrl+Alt+L** key combination).

Chapter 11. Using context menus for windows configuration setting

Users can specify windows configuration settings by hiding columns in the tables and changing their sequence order via the context menu items. Also, you can use mouse to stretch tables and drag them from one position to another.

The context menu item, which is set as the default (the action can be performed by double-clicking the left mouse button on the active line) is marked in bold.

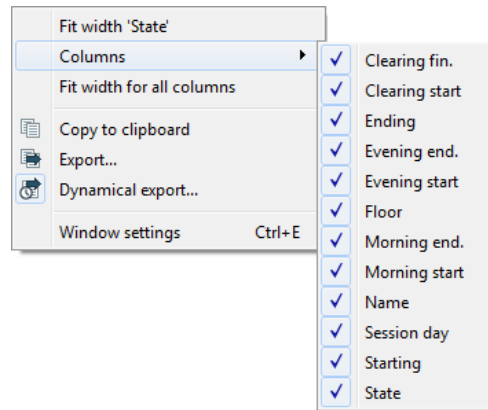



Fig. 11.1. Standard context menu

Below is the list of the standard context menu items available in every context menu:

- **Fit width** 'column's name' – allows to automatically set the column width in accordance with its content. This action can also be performed by placing mouse cursor on the line between two columns (the cursor should get arrow-shaped) and double-click the left mouse button;
- **Fit width for all columns** - allows to automatically fit width for all columns in according with their content;
- **Columns** – a context menu item, which displays the complete list of columns the current table contains. From here, you can easily hide a column from the table or display a previously hidden one by checking/unchecking the appropriate checkbox;
- **Export** – allows to export data from the current table into a **CSV** file (a text file format containing comma separators) or a dBase **DBF** file. A detailed description of the export procedure see section 5.12.1;
- **Dynamical export** – allows to export data from the current table into a **CSV** file (a text file format containing comma separators) or a dBase **DBF** file periodically at predetermined intervals. A detailed description of the export procedure see section 5.12.2.

When the dynamical export option is enabled for the current table, the icon  left of the menu item will be highlighted in light blue - see fig. 11.1;

- **Copy to clipboard** - allows to copy the window content into clipboard;
- **Window settings** - opens the **Settings** window, where you can specify some detailed window settings. The window parameters are grouped, and can be set separately. Each window has its own parameters:
 - **Main** – window name;
 - **View** – how the window elements will be highlighted;
 - **Columns** – list of columns the window contains;

- **Sorting** – how data in the window is sorted;
- **Filters** – available filtering masks.

The parameters list may contain some other groups, depending on the window type and its content. Information about some specific parameters, as well as of sorting and filtering options, can be found the appropriate sections of this manual.

Please note, that settings specified via the context menu will affect only the current window and all its entities. Every new window of the same type will be opened in the standard configuration settings specified in the main settings section (the main menu **Settings/ Terminal settings/ Main/ View**).

11.1. Main group window settings

The **Main** group allows to specify the window name in the **Name** field. The standard window name and a user defined ones are separated with slash. For example: **Futures - Financial instruments**, where **Futures** is the user defined name specified in the **Main** tab, while **Financial instruments** is the standard name of the window.

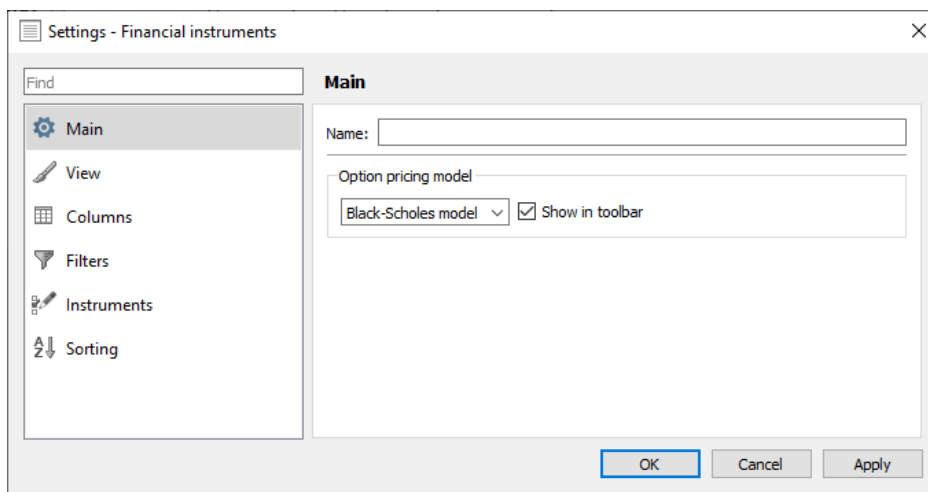

Fig. 11.2. Main group window settings

The **Main** group of settings also allows to configure the option pricing model. This setting is present only in those windows for which it is actual. The model can be selected from the drop-down list:

- Black-Scholes model - default setting;
- Bachelier model.

The **Show in toolbar** option allows to configure the widget for selecting an option pricing model in the window title bar, which allows to select a model without opening the settings window. By default, the option is disabled - the model selection widget is not displayed.

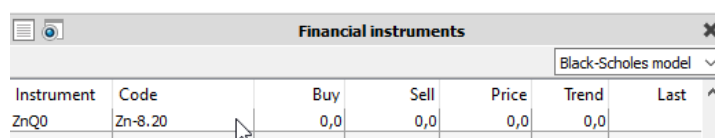

Fig. 11.3. Option pricing model widget

11.2. Highlight settings

There are elements in some windows, for which you can specify highlight settings. The list of the elements can be edited separately for each window via the **Window settings/ View** context menu item.

To enable/disable highlight option for an element, you should check or uncheck the appropriate checkbox.

Highlight colour scheme can be specified either via the **Window settings/ View/ Setup colours** context menu item or via the **Settings/ Terminal settings/ Colours** main menu item.

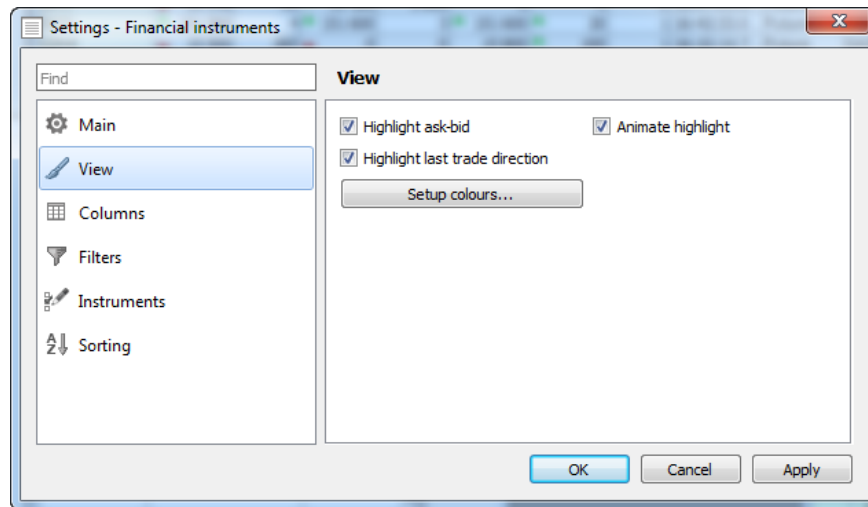

Fig. 11.4. Highlight settings

Tab. 11.1. Highlight settings

Parameter	Details
The Financial instruments and Options board windows	
Highlight buy/sell	The Buy and Sell cells will be highlighted at price change. The highlight is enabled for a limited time only (this option cannot be changed by user), and then the background colour changes to the standard one. The default colours are the following: red stands for price down-trend, green for price up-trend, and yellow for steady prices. Additionally, you can set background colour to slowly fade out using the Animate highlight option.
Animate highlight	Turning this option on makes a background colour slowly fading out until it disappears or another order appears. If the option is disabled, the colour changes instantly. The option is available only when the Highlight buy/sell option is enabled.
Highlight last trade direction	Allows to highlight the whole line containing the instrument for which the last trade was performed. The highlight is enabled for a limited time only (this option cannot be changed by user), and then the background colour changes to the standard one. The default colours are the following: red stands for the last trade price down-trend, green for the last trade price up-trend, and yellow for steady price.
The Your orders/ requests, Your trades/ requests, All trades/ requests windows	
Highlight lines	When the option is enabled, the lines will be highlighted in different colours depending on the order or trade direction. The order direction affects on that of trade. The default colours are the following: <ul style="list-style-type: none"> • red – sell; • green – buy.

The highlight colour can be specified by pressing the **Colours settings** button. For detailed information see section 10.5.

11.3. Columns settings

You can hide columns in tables and change their sequence order via the **Window settings** context menu item, in the **Columns** section:

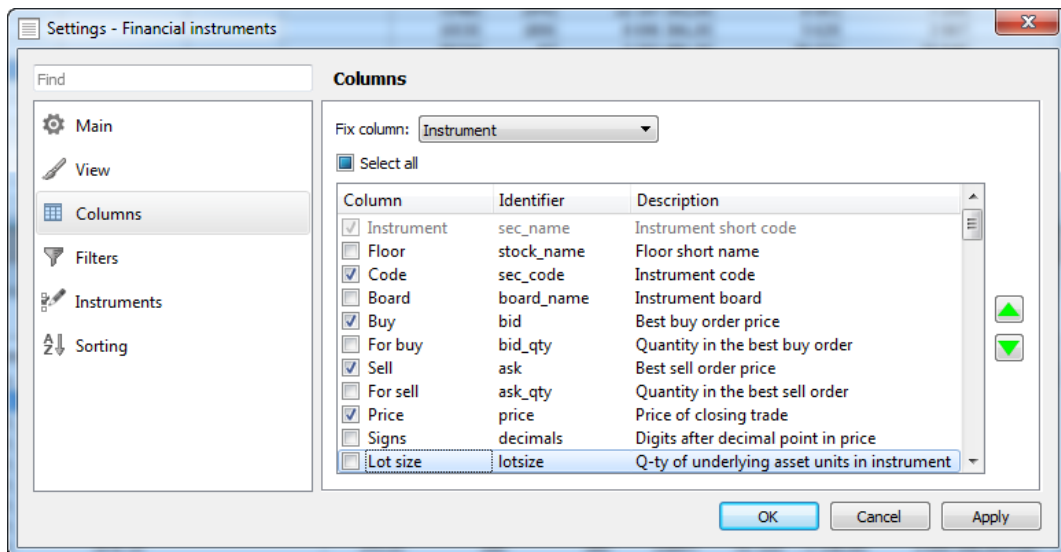

Fig. 11.5. Columns settings

The checkboxes left from the column name displays the current state of each column (enabled/disabled). If a checkbox is active, the appropriate column will be displayed in the table, and vice versa.

The **Select all** option allows to enable all columns in the list. Clicking **Select all** again disables all columns. If some columns are left disabled, the **Select all** item is highlighted in blue.

The **Fix column** field contains the column name which will be fixed in the current window.

The fixed column itself is highlighted in yellow. This column is always displayed as the first column in the table and never hides even when you scroll the table to the right. You can fix any column in the table. The records in the column can be arranged by clicking the column header with the left mouse button as it can be performed for any other column.

Please note, that the **Fix column** field is available not in all windows. For the current software version, you can set fixed columns only in the **Financial instruments** window.

The order of columns can be set with the special buttons with arrows left of the list. You can move only one line at once (the one under the mouse cursor); the higher is the line in the list, the closer is the column to the left side of the table. Also, you can move lines in the list by drag it with the mouse cursor and drop to the position you need.

The column **Identifier** of the settings window contains some internal identifiers for fields. When exporting data, the field names are taken from these identifiers.

The **Apply** button saves the changes you made, leaving the settings window open.

The **Cancel** button cancels all the changes you made and closes the settings window.

The **OK** button saves the changes you made and closes the settings window.

The **Columns** context menu item allows to change the parameters settings in a fast mode; to do this, open the context menu from the column header by clicking it with the right mouse button. Please note, that you cannot change columns order this way!

Index

request to NCC, 118

A

abnormal termination, 27
 administrator's messages, 159
 all trades, 135
 contextual menu, 138
 filters, 136
 automatic update, 16

C

change password, 22
 charts
 change instrument, 269
 colours, 298
 confirmation settings, 290
 contextual menu, 260
 creating, 261
 hide, 271
 ISS service, 292
 lost, 271
 name, 272
 offset, 299
 open in one area, 269
 properties, 263
 remove, 272
 replace, 270, 271
 review, 273
 scale, 273
 series settings, 295
 session schedule, 294
 setting the display bar, 292
 settings, 290
 to pin to the same vertical axis, 270
 toolbar, 256
 types, 253
 window, 255
 client assets (clearing), 237
 collateral breakdown, 238
 collateral transfer requests, 246
 information, 251
 new request, 248
 toolbar, 248
 connection error messages, 41
 context menu, 55
 contextual search, 53

D

data export, 60, 60, 61
 disconnection, 26
 dynamical order adding, 127

E

edit fields, 53

errors and notifications, 160
 event log, 335
 exercise options, 170
 order, 170
 rules, 171
 Exit the application, 25

F

favorite instruments, 58
 access, 57
 filtering, 54
 settings, 55
 financial instruments, 67
 contextual menu, 75
 filter for instruments, 72
 filters, 70
 general information, 11
 sorting, 74
 functional windows, 41
 funds by settlement accounts, 211

H

Hardware configurations, 13

I

iceberg order, 117
 indicator editor, 283, 283
 elements of language QScript, 287
 functions, 286
 indicators, 264
 creating, 266
 indicator selection, 267
 properties, 267
 settings, 297
 information, 64
 installation package setup, 13
 instrument panel, 37
 interface, 29

L

limitation, 202
 limits
 client changing, 208
 client setting, 207
 lock mode, 209
 Option exercise rules, 230
 remove, 232
 request to NCC, 211
 setting for BF, 208
 toolbar, 206
 transfer funds, 210

M

main menu, 30
 main window, 29
 Tech. analysis, 255
 main windows

- Administrator's messages, 159
 - All trades/ requests, 135
 - Client assets (clearing), 237
 - Collateral breakdown, 238
 - Collateral transfer requests, 246
 - Configurations managing, 41
 - Edit TA data, 304
 - Errors and notifications, 160
 - Favorite instruments, 58
 - Financial instruments, 67
 - Indicator editor
 - Functions, 286
 - Indicators, 283
 - Information, 64
 - Limitation, 202
 - Manage BF parameters, 213
 - Manage client parameters, 216
 - Market maker obligations for futures, 196
 - Market maker obligations for IQS futures, 196
 - Market maker obligations for IQS options, 192
 - Market maker obligations for options, 192
 - Messages, 133
 - Money, 79
 - News, 77
 - Object manager
 - Drawings, 282
 - Indicators, 281
 - Series, 281
 - Option exercise rules, 230
 - Options board, 162
 - Order-book, 97
 - Placing order, 113
 - Position profiles transfer requests, 242
 - Positions by settlement accounts, 85
 - Positions/ requests, 79
 - Prohibitions on operations, 222
 - Request to NCC, 118
 - Requests to deposit/ withdraw funds, 238
 - RFS (active streams), 147
 - Select instrument, 56
 - Sessions, 76
 - Settings, 306
 - Charts and TA, 290, 329
 - Colours, 315
 - Common, 306
 - Confirmations, 310
 - Database, 318
 - Information, 328
 - Keyboard, 320
 - Management, 320
 - Network, 323
 - News, 314
 - Option calculator, 324
 - Plugins, 325
 - Sounds, 326
 - TA archival data, 327
 - Trading, 329
 - Transport, 330
 - View, 308
 - Settlement account assets, 211
 - Settlement account assets (clearing), 236
 - SMA-user order verification, 233
 - TA data export wizard, 302
 - TA data import wizard, 299
 - Users, 232
 - Your orders/ requests, 88
 - Your trades/ requests, 139
 - manage bf parameters, 213
 - manage client parameters, 216
 - brokerage part parameters of client fee, 221
 - client parameters used immediately, 219
 - client parameters used in evening clearing, 218
 - expiration risks parameters, 220
 - toolbar, 218
 - management, 192
 - market maker obligations for futures, 196
 - filters, 199
 - setting sound notification, 201
 - setting visual warning, 202
 - market maker obligations for iqs futures, 196
 - market maker obligations for iqs options, 192
 - market maker obligations for options, 192
 - Market maker obligations for options
 - filters, 195
 - messages, 133, 159
 - administrator's, 159
 - errors, 160
 - transactions errors, 161
 - money, 79
 - multi-leg instruments operations, 144
- N**
- negotiated operations, 142
 - news, 77
 - setting of sounds, 78
- O**
- object manager, 280
 - drawing, 282
 - indicators, 281
 - series, 281
 - options board, 162
 - contextual menu, 169
 - filter for instruments, 167
 - filters, 165
 - sorting, 168
 - options calculator, 173
 - add position, 182
 - add strategy, 183
 - batch entry, 177
 - charts, 190
 - chats, 188
 - export, 185, 191, 191
 - import, 180
 - option greeks, 186

- postponed orders, 177
 - real portfolio, 175
 - recalculate collateral, 185
 - remove position, 185
 - toolbar, 174
 - virtual portfolio, 177
 - options exercise
 - rules, 230
 - setting rule, 231
 - toolbar, 231
 - order-book, 97
 - contextual menu, 112
 - highlight volume, 103
 - narrow mode, 100
 - one-click trading, 104, 106
 - opening position, 111
 - opening price, 111
 - orders panel, 109
 - position indicator, 110
 - rarefied mode, 102
 - save center, 102
 - setting of sounds, 111
 - sorting, 104
 - standard mode, 99
 - toolbar, 98
 - view, 98
 - wide mode, 101
 - orders, 88
 - add, 113
 - add negotiated, 143
 - anonymous multi-leg instruments, 145
 - batch entry, 122
 - cancel, 132
 - change, 96
 - check for limits, 133
 - dynamical adding, 127
 - indicative, 119
 - multi-leg instruments, 144
 - negotiated, 143
 - negotiated multi-leg instruments, 145
 - placing order, 113
 - postponed, 122
 - synthetic, 120
 - unprocessed, 40, 131
- P**
- position profiles transfer requests, 242
 - information, 245
 - new, 243
 - toolbar, 243
 - positions
 - filtering, 83
 - toolbar, 82
 - transfer position, 82
 - positions by SA, 85
 - filtering, 86
 - positions/requests, 79
 - postponed orders, 122
 - adding, 124
 - import, 125
 - removing, 125
 - sending, 125
 - toolbar, 123
 - prohibitions, 222
 - change, 229
 - group of prohibitions, 226
 - on adding option exercising orders, 229
 - RFS, 229
 - setting, 224
 - toolbar, 224
- Q**
- quotation board, 332
- R**
- requests to deposit/withdraw funds, 238
 - rfs (active stream)
 - filters, 150
 - rfs (active streams), 147
 - cancel provider quotes, 156
 - liquidity stream, 152
 - make a trade, 157
 - provider quotes, 154
 - stop auction, 158
 - toolbar, 149
 - risk balancing, 134
- S**
- select instrument, 56
 - sessions, 76
 - setting
 - sound notification, 201
 - sounds, 78
 - visual warning, 202
 - setting from the context menu, 336
 - settings, 306
 - average position price, 329
 - charts, 329
 - colours, 315
 - confirmations, 310
 - database, 318
 - hot keys, 320
 - information, 328
 - ISS service, 333
 - management, 320
 - network, 323
 - news, 314
 - notification, 306
 - option calculator, 324
 - plugins, 325
 - profiles, 333
 - save, 334
 - sounds, 95, 111, 326
 - TA archival data, 327
 - transport, 330

- view, 308
- settlement account assets (clearing), 236
- side panel, 38
- sma-user order verification, 233
- sort, 53
- SPECTRA, 10
- status line, 40

T

- TA data, 299
 - edit, 304
 - export, 302
 - import, 299
- tabs, 44
 - actions with tabs, 44
 - panels, 46
 - window, 45
- the trading system administrator's messages, 41
- trades, 134
 - contextual menu, 142
 - last, 40
 - multi-leg instruments, 146
 - negotiated, 144
- trading operations, 11
- trading participants, 10
- transport
 - connecting, 23
 - disconnect, 24
 - reconnect, 25
 - statuses, 26
 - testing connection, 24
- trend line, 274
 - Fibonacci arcs, 276
 - Fibonacci fan, 277
 - Fibonacci lines, 275
 - hide, 279
 - horizontal, 275
 - properties, 278
 - remove, 279
 - replace, 279, 279

U

- user roles, 19
- user sign in, 22
- users, 232

V

- version update, 13
- volatility curve, 172

W

- window
 - active, 49
 - arrange, 48
 - close, 52
 - maximize, 51
 - minimize, 50

- move, 51
- new window as tabs of current, 52
- on top, 51
- save as default, 52
- size, 51
- switch between windows, 52
- unpinned, 47
- window settings
 - columns, 339
 - highlight, 337
 - window appearance, 337
- withdraw funds, 238
 - order, 240
 - recall order, 241
- withdrawal order wizard, 240
- workspace configuration
 - active, 42
 - basic, 43
 - manage, 41
 - new, 42
 - restore, 43
 - restore default settings, 43
 - save, 43

Y

- your orders
 - context menu, 94
 - filters, 91
 - setting of sounds, 95
- your orders/requests, 88
- your trades
 - filters, 142
 - setting of sounds, 95
- your trades/requests, 139

List of Figures

1.1. Function diagram of the trading terminal	12
2.1. Trading terminal Setup Wizard.	14
2.2. Application Setup Wizard. Choosing Setup type.	14
2.3. Desktop shortcut settings.	15
2.4. Application Setup Wizard. Installation confirmation.	15
2.5. Application Setup Wizard. Installation progress.	16
2.6. Application Setup Wizard. Finishing setup.	16
2.7. Automatic update. Notification on a new version.	17
2.8. Automatic update. Notification message in the notification bar.	17
2.9. Automatic update. Selecting download folder.	18
2.10. Automatic update. Download process.	18
2.11. Automatic update. Installing new version.	18
2.12. Automatic update. Notification on restart.	19
4.1. Change password window	22
4.2. User sign in window	23
4.3. The sign up window when a network error occurs	24
4.4. Testing results window	24
4.5. Transport disconnect confirmation window	25
4.6. Exit confirmation	25
4.7. Transport status	26
4.8. Automatic reconnection to the server	27
4.9. The Connections window at disconnect	27
4.10. Abnormal termination error message	27
4.11. Abnormal termination report	28
5.1. Trading terminal main window	30
5.2. Instrument panel	37
5.3. Side panel	39
5.4. Status line	40
5.5. Workspace configurations management	42
5.6. Creating new workspace configuration	43
5.7. Window tab	45
5.8. Context menu for additional window	46
5.9. Panel tabs	47
5.10. Menu line in unpinned window	48
5.11. Windows arranged side by side	49
5.12. Cascaded windows	49
5.13. Menu - Active window	50
5.14. Context menu, window title line	50
5.15. Minimized windows	51
5.16. Sorting by column	53
5.17. Contextual search	54
5.18. Select instrument window	56
5.19. Side panel - Favorite instruments	57
5.20. Favorite instruments - menu	58
5.21. Favorite instruments window	59
5.22. Select the export data's format	61
5.23. Data export window	61
5.24. Dynamical export settings	62
5.25. Dynamical export progress bar	62
5.26. Dynamical export icon in the application status bar	62
5.27. Window 'Dynamical export'	62
6.1. Information window	65
6.2. Window Financial instruments	67
6.3. Filter settings in the Financial instruments window	71
6.4. Filter for instruments in the Financial instruments window	73

6.5. Sorting in the Financial instruments window	75
6.6. The Sessions window	77
6.7. News window	77
6.8. Sound settings on adding a new string in the table	78
6.9. Money window	79
6.10. Positions/ requests window	80
6.11. Transfer position window	82
6.12. Filtering settings in the Positions/ requests window	84
6.13. 'Positions by settlement accounts' window	85
6.14. Filtering settings in the 'Positions by settlement accounts' window	87
6.15. Your orders/ requests window	89
6.16. Filtering settings in the Your orders/ requests window	92
6.17. Sound settings on adding a new string in the table	96
6.18. 'Change order' window	96
6.19. Setting the Order-book window appearance	98
6.20. Order-book window. Standard mode	99
6.21. The Order-book window. Narrow mode	100
6.22. Order-book window. Wide mode	101
6.23. Order-book window. Rarefied mode	102
6.24. Order-book window. Standard mode with fixed center	102
6.25. Order-book window. Narrow rarefied mode with fixed center	103
6.26. Order volume highlight settings	103
6.27. One-click trading setting	104
6.28. Setting hotkeys for One-click trading mode	107
6.29. Orders panel	109
6.30. Orders panel settings	109
6.31. Position indicator	110
6.32. Setting a sound warning at adding orders and matching trades	112
6.33. Adding order. Order adding mode	114
6.34. Adding order. Editing mode	114
6.35. Order adding error message	117
6.36. Add iceberg order	117
6.37. Request to NCC	119
6.38. Order-book. Indicative Quote mode	120
6.39. Postponed orders	122
6.40. Order adding scenarios window	124
6.41. Data import wizard	126
6.42. Data structure in CSV file	127
6.43. Dynamical order adding	127
6.44. File selection	129
6.45. File selection window	130
6.46. Unprocessed orders	131
6.47. Transaction queue clearing button	131
6.48. Cancel all orders	132
6.49. Check for limits window	133
6.50. Check for multiplicity window	133
6.51. Messageswindow	133
6.52. Adding a risk balancing request	134
6.53. All trades/ requests window	135
6.54. Filtering settings in the All trades/ requests window	137
6.55. Your trades/ requests window	139
6.56. Adding a negotiated order	144
6.57. Adding order for the anonymous multi-leg instruments	145
6.58. Adding order for negotiated multi-leg instruments	146
6.59. 'RFS (active streams)' window	148
6.60. Filtering settings in the 'RFS (active streams)' window	151
6.61. 'Add liquidity stream' window	152
6.62. Notification for provider	154

6.63. Liquidity notification	154
6.64. Adding quote by LP to stream	155
6.65. Cancellation of provider quotes	157
6.66. Notification to the provider about the need to confirm the indicative trade	158
6.67. New trading system/Administrator's message	159
6.68. Administrator's messages	160
6.69. A system message which contains a hyper-link	160
6.70. Errors and notifications window	161
7.1. Options board	163
7.2. Setting filters in the Options board window	166
7.3. Filtering by instruments in the Options board window	167
7.4. Sorting in the Options board window	169
7.5. Exercise option	170
7.6. Volatility curve	172
7.7. Options calculator	173
7.8. Options calculator. Real portfolio	175
7.9. Postponed orders	177
7.10. Options calculator. Virtual portfolio	177
7.11. Select a file to import	181
7.12. Option calculator data importing Wizard. The first screen.	181
7.13. Option calculator data importing Wizard. All the mandatory fields selected.	182
7.14. Import error message	182
7.15. Import completed successfully message	182
7.16. Options calculator. Adding a position into virtual portfolio.	183
7.17. Options calculator. Add strategy to virtual portfolio.	184
7.18. Options calculator. Charts	189
7.19. Options calculator. Charts - What if? area	190
7.20. Export CSV file for charts	191
7.21. Export JPG file for charts	191
8.1. Window Market maker obligations for options	193
8.2. Setting filters in the Market maker obligations for options window	195
8.3. The Market maker obligations for futures window in table mode	197
8.4. The Market maker obligations for futures window in tree mode	197
8.5. Setting filters in the Market maker obligations for futures window	200
8.6. Setting sound notifications	201
8.7. Setting visual warning	202
8.8. Limitation window for CF	203
8.9. Limitation window for BF	203
8.10. Limitation window for client	204
8.11. Setting the client limits	207
8.12. Setting BF limits	208
8.13. Changing client limits	209
8.14. Lock mode	209
8.15. Funds transfer between BF	210
8.16. Request to NCC for collateral verification of Brokerage Firm	211
8.17. Settlement account assets	212
8.18. Manage BF parameters	213
8.19. Specify BF's parameters	214
8.20. Set shared parameters for BF's clients	216
8.21. Manage client parameters	216
8.22. Setting client parameters used in evening clearing	218
8.23. Setting client parameters used immediately	219
8.24. Setting the expiration risks parameters	220
8.25. Parameters for calculating the brokerage part of the client fee	221
8.26. Window Prohibitions	222
8.27. Setting prohibitions on operations	225
8.28. Setting group of prohibitions	227
8.29. Option exercise rules	230

8.30. Setting a new options exercise rule	231
8.31. Users	232
8.32. SMA-user order verification	233
8.33. Add SMA-user pre-trade verification	235
8.34. Settlement account assets (clearing)	236
8.35. Client assets (clearing)	237
8.36. Window Collateral breakdown	238
8.37. Requests to deposit/withdraw funds	239
8.38. Withdrawal request wizard - Details	240
8.39. Withdrawal request wizard - Requests	241
8.40. Position profiles transfer requests	242
8.41. Position profiles transfer by asset	244
8.42. Position profile transfer request information	246
8.43. Collateral transfer requests	247
8.44. Collateral transfer window	249
8.45. Collateral profile transfer requests information	251
9.1. Chart type - Linear	254
9.2. Bar	254
9.3. Candles	254
9.4. Chart type - Japanese Candlestick	254
9.5. Chart type - Bars	255
9.6. Selected chart in the Tech. analysis window	255
9.7. Hint with chart parameters	260
9.8. Chart properties	263
9.9. Example of indicator chart created in the same area with the main series chart	265
9.10. Example of indicator chart created in the separate area	266
9.11. Indicator selecting window	267
9.12. Indicator chart properties	268
9.13. Charts with different vertical axis	270
9.14. Charts with the same vertical axis	270
9.15. The Tech. analysis window (all objects are hidden)	272
9.16. Trend line	274
9.17. Resistance and support levels	275
9.18. Fibonacci lines	276
9.19. Fibonacci arcs	276
9.20. Fibonacci fan	277
9.21. Trend line and Fibonacci lines properties	278
9.22. Horizontal line properties	278
9.23. Object manager. Series.	281
9.24. Object manager. Indicators.	282
9.25. Object manager. Drawings.	282
9.26. Indicator code editor	283
9.27. Adding a new indicator	284
9.28. Entering indicator code	284
9.29. Chart style indicator	285
9.30. Functions editor	286
9.31. Adding a new function	286
9.32. Entering function code	286
9.33. Charts and TA. The Confirmations tab.	291
9.34. Charts and TA. The Main tab.	293
9.35. Charts and TA. The Session schedule tab.	294
9.36. Editing session parameters for charts	295
9.37. Charts and TA. The Series chart tab.	295
9.38. Charts and TA. The Indicators tab.	297
9.39. Charts and TA. The Colours tab.	298
9.40. Data structure	300
9.41. TA data import wizard. Series.	300
9.42. TA data import wizard. Format.	301

9.43. TA data import wizard. Columns.	302
9.44. Import error message	302
9.45. Import completed successfully message	302
9.46. TA data export wizard. Series.	303
9.47. TA data export wizard. Format.	303
9.48. Message window	304
9.49. The Edit TA data window	304
10.1. Settings/ Terminal settings menu	306
10.2. Administrator's message notification	307
10.3. Settings. The Main/ Common tab	307
10.4. Settings. The Main/ View tab.	309
10.5. Confirmations settings	311
10.6. News sources settings	314
10.7. Colours settings	316
10.8. Database settings	319
10.9. Management settings	320
10.10. Hot keys settings	321
10.11. Proxy-server settings	324
10.12. Confirmations settings for the option calculator module	324
10.13. Plugins settings	326
10.14. Sounds settings	327
10.15. TA archival data settings	328
10.16. Information settings	329
10.17. Average position price setting	330
10.18. Transport settings	331
10.19. Connection profiles	333
10.20. Data load settings	334
10.21. The About window	335
11.1. Standard context menu	336
11.2. Main group window settings	337
11.3. Option pricing model widget	337
11.4. Highlight settings	338
11.5. Columns settings	339

List of Tables

1. List of abbreviations	9
2.1. PC configuration	13
4.1. User sign in window fields	23
5.1. Main menu commands	31
5.2. Instrument panel items	38
5.3. Trading terminal functional windows	41
5.4. The workspace configurations management buttons	42
6.1. Parameters in window Financial instruments	67
6.2. Filter parameters in the Financial instruments window	71
6.3. Parameters in the Sessions window	77
6.4. Parameters in news window	78
6.5. Parameters in the Money window	79
6.6. Parameters in the Positions/ requests window	80
6.7. Toolbar of the Positions/ requests window	82
6.8. Parameters in the Transfer position window	82
6.9. Filter parameters in the 'Positions/ requests' window	84
6.10. Parameters in the ' Positions by settlement accounts ' window	85
6.11. Filter parameters in the 'Positions by settlement accounts' window	87
6.12. Parameters in Your orders/ requests window	89
6.13. Filtering parameters in the Your orders/ requests window	92
6.14. Toolbar of the Order-book window	98
6.15. Parameters in the Order-book window – Standard mode	100
6.16. Parameters in the Order-book window – narrow mode	100
6.17. Parameters in the Order-book window – wide mode	101
6.18. Setting the One-click trading options	105
6.19. List of hotkeys for the One-click trading mode	107
6.20. Parameters in the Add order window	115
6.21. Parameters of the Postponed orders window	122
6.22. Toolbar of the Postponed orders window	123
6.23. Dynamical order adding window parameters	127
6.24. Buttons of instrument panel in window Dynamical order adding	129
6.25. Risk balancing request parameters	134
6.26. All trades/ requests window parameters	135
6.27. Filtering parameters in the All trades/ requests window	137
6.28. Parameters in the Your trades/ requests window	140
6.29. Parameters in 'RFS (active streams)' window	148
6.30. Toolbar of the 'RFS (active streams)' window	149
6.31. Filtering parameters in the 'RFS (active streams)' window	151
6.32. Parameters in the 'Add liquidity stream' window	153
6.33. LP quote parameters	155
6.34. Quotes selection parameters for cancel	157
7.1. Parameters in the Options board tab	163
7.2. Filtering parameters in the Options board window	166
7.3. Toolbar of Option calculator	174
7.4. Parameters in Real portfolio area	175
7.5. Parameters in Virtual portfolio area	178
7.6. Parameters in the Add position into virtual portfolio window	183
7.7. Parameters of option strategy	184
7.8. Greeks calculation formulas for Black - Scholes option pricing model	186
7.9. Greeks calculation formulas for Bachelier option pricing model	188
8.1. Parameters in the Market maker obligations for options and Market maker obligations for IQS options windows	193
8.2. Filter parameters in the Market maker obligations for options window	195
8.3. Parameters in the Market maker obligations for futures and Market maker obligations for IQS futures windows	198

8.4. Filter parameters in the Market maker obligations for futures window	200
8.5. Parameters in the Limitation window	204
8.6. Toolbar in the Limitation window	206
8.7. Parameters in the Setting limits window for clients	207
8.8. Parameters in the Setting BF limits window	208
8.9. Parameters in Funds transfer between BF window	210
8.10. Settlement account assets window parameters	212
8.11. Parameters in Manage BF parameters window	213
8.12. Parameters in Specify BF's parameters window	215
8.13. Parameters in Set shared parameters for BF's clients window	216
8.14. Parameters in Manage client parameters window	217
8.15. Toolbar in the Manage client parameters window	218
8.16. Parameters in Client parameters used in evening clearing window	219
8.17. Parameters in Client parameters used immediately window	219
8.18. Parameters in the Expiration risks parameters window	220
8.19. Parameters in "Parameters for calculating the brokerage part of the client fee" window	221
8.20. Parameters in the Prohibitions window	223
8.21. Toolbar of the Prohibitions window	224
8.22. Parameters in the New prohibition window	225
8.23. Parameters in the New group of prohibitions window	227
8.24. Parameters in the Option exercise rules window	230
8.25. Toolbar in the Option exercise rules window	231
8.26. Parameters in the New rule window	231
8.27. Parameters in the Users window	232
8.28. Parameters in SMA-user order verification window	234
8.29. Parameters in Add SMA-user pre-trade verification window	235
8.30. Settlement account assets (clearing) window parameters	236
8.31. Client assets (clearing) window parameters	237
8.32. Parameters in the Collateral breakdown window	238
8.33. Parameters in the Requests to deposit/ withdraw funds window	239
8.34. Parameters in the Position profiles transfer requests window	242
8.35. Toolbar of the Position profiles transfer requests window	243
8.36. Parameters of the Position profiles transfer by asset	244
8.37. Parameters of the Collateral transfer requests window	247
8.38. Toolbar of the Collateral transfer requests window	248
8.39. Parameters of the Collateral transfer window	249
9.1. Toolbar for Tech. analysis	257
9.2. Trend line properties	278
9.3. Function buttons in the Object manager window	280
9.4. Parameters in the Series tab (Object manager)	281
9.5. Parameters in the Indicators tab (Object manager)	282
9.6. Parameters in the Drawings tab (Object manager)	282
9.7. QScript language extension	287
9.8. Parameters in the Confirmations tab	291
9.9. Parameters in the Session schedule tab	294
9.10. Parameters in the Chart of series tab	296
9.11. Parameters in the Indicators tab	297
9.12. Parameters in the Colours tab	299
10.1. Parameters in the Common tab	307
10.2. Parameters of the View tab	309
10.3. Confirmations	311
10.4. News sources parameters	315
10.5. Colour settings	316
10.6. Database settings	319
10.7. Hot keys	321
10.8. Confirmations in the option calculator	325
10.9. Plugins	326
10.10. Parameters in the Settings/ Transport/ Plaza2 tab	331

10.11. Connection parameters to the ISS server 334
11.1. Highlight settings 338

List of Procedures

9.1. Creating a chart in a new window via the main menu	262
9.2. Creating a chart from the All trades/ requests, Financial instruments, Order-book windows via the context menu	262
9.3. Dragging a chart into the already opened window	262
9.4. Creating a chart in the new Tech. analysis window	262
9.5. Creating chart in a new area of the opened Tech. analysis window	263
9.6. Creating of indicator chart using toolbar in the Tech. analysis window	266
9.7. How to pin several charts to the same vertical axis	271
9.8. How to unpin a chart from a vertical axis	271
9.9. How to add a trend line	275
9.10. How to add a resistance /support level	275
9.11. How to add Fibonacci lines	276
9.12. How to add Fibonacci arcs	277
9.13. How to add Fibonacci fan	277